

Use this manual if you encounter any problems, or have any questions about your product.



[Interval shooting](#)

You can automatically shoot a series of still images with the shooting interval and number of shots that you set in advance.



[Looking for valuable information, such as essential points on shooting \(Tutorials\)](#)

This website introduces convenient functions, ways of usage, and setting examples. Refer to the website when you set up your camera. (Another window will open.)



[ILCE-6100 lens compatibility information](#)

This website provides the lens compatibility information. (Another window will open.)

Names of parts/Icons and indicators

[Identifying parts](#)

Basic operations

[Using the control wheel](#)

[Using MENU items](#)

[Assigning frequently used functions to buttons \(Custom Key\)](#)

[Using Fn \(Function\) button \(Function menu\)](#)

[How to use the Quick Navi screen](#)

[How to use the keyboard](#)

Icons and indicators

[List of icons on the monitor](#)

[Switching the screen display \(while shooting/during playback\)](#)

[DISP Button \(Monitor/Finder\)](#)

Preparing the camera

[Checking the camera and the supplied items](#)

[E PZ 16–50mm F3.5–5.6 OSS \(Power zoom\)](#)

[E 55-210 mm F4.5-6.3 OSS \(supplied with ILCE-6100Y\)](#)

Charging the battery pack

[Inserting/removing the battery pack](#)

[Charging the battery pack while it is inserted in the camera](#)

[Charging by connecting to a computer](#)

[Battery life and number of recordable images](#)

[Supplying power from a wall outlet \(wall socket\)](#)

[Notes on the battery pack](#)

[Notes on charging the battery pack](#)

Inserting a memory card (sold separately)

[Inserting/removing a memory card](#)

[Memory cards that can be used](#)

[Notes on memory card](#)

Attaching a lens

[Attaching/removing a lens](#)

[Attaching the lens hood](#)

Attaching accessories

- [Mount Adaptor](#)

- [LA-EA1/LA-EA3 Mount Adaptor](#)

- [LA-EA2/LA-EA4 Mount Adaptor](#)

[Setting language, date and time](#)

[In-Camera Guide](#)

Shooting

[Shooting still images](#)

Focusing

- [Focus Mode](#)

Auto focus

- [Focus Area](#)

- [Phase detection AF](#)

- [Focus Standard](#)

- [AF/MF control](#)

- [AF w/ shutter \(still image\)](#)

- [AF On](#)

- [Face/Eye AF Set.](#)

- [AF in Focus Mag. \(still image\)](#)

- [Tracking subject \(Tracking function\)](#)

- [Focus Hold](#)

- [Pre-AF \(still image\)](#)

- [Eye-Start AF \(still image\)](#)

- [AF Illuminator \(still image\)](#)

- [AF Area Auto Clear](#)

- [Disp. cont. AF area](#)

- [AF Micro Adj.](#)

Manual focus

- [Manual Focus](#)

- [Direct manual focus \(DMF\)](#)
- [Focus Magnifier](#)
- [MF Assist \(still image\)](#)
- [Focus Magnif. Time](#)
- [Initial Focus Mag_\(still image\)](#)
- [Peaking Setting](#)

Selecting a drive mode (Continuous shooting/Self-timer)

- [Drive Mode](#)
- [Cont. Shooting](#)
- [Self-timer](#)
- [Self-timer\(Cont\)](#)
- [Cont. Bracket](#)
- [Single Bracket](#)
- [Indicator during bracket shooting](#)
- [WB bracket](#)
- [DRO Bracket](#)
- [Bracket Settings](#)

Taking pictures of yourself by monitoring the screen

- [Self-portrait/ -timer](#)

Interval shooting

- [Interval Shoot Func.](#)

Using touch functions

- [Touch Operation](#)
- [Touch Panel/Pad](#)
- [Func. of Touch Operation: Touch Shutter](#)
- [Func. of Touch Operation: Touch Focus](#)
- [Func. of Touch Operation: Touch Tracking](#)
- [Touch Pad Settings](#)

Selecting still image size/image quality

- [File Format \(still image\)](#)

[JPEG Quality \(still image\)](#)

[JPEG Image Size \(still image\)](#)

[Aspect Ratio \(still image\)](#)

[Panorama: Size](#)

[Panorama: Direction](#)

Selecting a shooting mode

[List of mode dial function](#)

[Intelligent Auto](#)

[Superior Auto](#)

[Superior Auto Img. Extract.](#)

[Switching the auto mode \(Auto Mode\)](#)

[About Scene Recognition](#)

[Program Auto](#)

[Aperture Priority](#)

[Shutter Priority](#)

[Manual Exposure](#)

[Bulb shooting](#)

[Sweep Panorama](#)

[Scene Selection](#)

[Recall \(Camera Settings1/Camera Settings2\)](#)

[Movie: Exposure Mode](#)

[S&Q Motion: Exposure Mode](#)

Controlling the exposure/metering modes

[Exposure Comp.](#)

[Dial/Wheel Ev Comp](#)

[Exposure Set. Guide](#)

[Exposure step](#)

[Metering Mode](#)

[Face Priority in Multi Metering](#)

[AE lock](#)

[AEL w/ shutter \(still image\)](#)

[Exp.comp.set](#)

[Zebra Setting](#)

Correcting brightness and contrast automatically

[D-Range Optimizer \(DRO\)](#)

[Auto HDR](#)

Selecting the ISO sensitivity

[ISO](#)

Using the zoom

[The zoom features available with this product](#)

[Clear Image Zoom/Digital Zoom \(Zoom\)](#)

[Zoom Setting](#)

[About zoom scale](#)

White balance

[White Balance](#)

[Priority Set in AWB](#)

[Capturing a standard white color to set the white balance \(custom white balance\)](#)

Setting how to process images

[Creative Style](#)

[Picture Effect](#)

[Soft Skin Effect \(still image\)](#)

[Auto Object Framing \(still image\)](#)

[Color Space \(still image\)](#)

Shutter settings

[Release w/o Lens](#)

[Release w/o Card](#)

[Silent Shooting \(still image\)](#)

[e-Front Curtain Shutter](#)

Reducing blur

[SteadyShot](#)

Lens compensation

- [Lens Comp.](#)

Noise reduction

- [Long Exposure NR \(still image\)](#)
- [High ISO NR \(still image\)](#)

Face detection

- [Regist. Faces Priority](#)
- [Smile Shutter](#)
- [Face Registration \(New Registration\)](#)
- [Face Registration \(Order Exchanging\)](#)
- [Face Registration \(Delete\)](#)

Using the flash

- [Using flash](#)
- [Red Eye Reduction](#)
- [Flash Mode](#)
- [Flash Comp.](#)
- [FEL lock](#)
- [Wireless Flash](#)

Recording movies

[Shooting movies](#)

[Movie w/ shutter](#)

[Movie recording formats](#)

[File Format \(movie\)](#)

[Record Setting \(movie\)](#)

[S&Q Settings](#)

[Proxy Recording](#)

[Audio Recording](#)

[Audio Level Display](#)

[Audio Rec Level](#)

[Wind Noise Reduct.](#)

[Auto Slow Shutter \(movie\)](#)

[Initial Focus Mag. \(movie\)](#)

[AF drive speed \(movie\)](#)

[AF Tracking Sens. \(movie\)](#)

[MOVIE Button](#)

[Marker Display \(movie\)](#)

[Marker Settings \(movie\)](#)

[4K Output Select \(movie\)](#)

Viewing

Viewing images

- [Playing back still images](#)
- [Enlarging an image being played back \(Enlarge Image\)](#)
- [Rotating recorded images automatically \(Display Rotation\)](#)
- [Rotating an image \(Rotate\)](#)
- [Playing back panoramic images](#)
- [Enlarge Initial Mag.](#)
- [Enlarge Initial Position](#)
- [Playing back movies](#)
- [Volume Settings](#)
- [Photo Capture](#)
- [Playing back images on the image index screen \(Image Index\)](#)
- [Setting the method for jumping between images \(Image Jump Setting\)](#)
- [Switching between still images and movies \(View Mode\)](#)
- [Display as Group](#)
- [Cont. PB for Interval](#)
- [PB Speed for Interval](#)
- [Playing back images using slideshow \(Slide Show\)](#)

Protecting data

[Protecting images \(Protect\)](#)

Setting Rating function

[Rating](#)

[Rating_Set\(Custom Key\)](#)

Designating images for printing (DPOF)

[Specifying images to be printed \(Specify Printing\)](#)

Deleting images

[Deleting a displayed image](#)

[Deleting multiple selected images \(Delete\)](#)

[Delete confirm](#)

Viewing images on a TV

[Viewing images on a TV using an HDMI cable](#)

Customizing the camera

Registering frequently used functions

[Memory \(Camera Settings1/Camera Settings2\)](#)

Customizing the functions of the dial

[Dial/Wheel Setup](#)

[Dial / Wheel Lock](#)

Customizing MENU (My Menu)

[Add Item](#)

[Sort Item](#)

[Delete Item](#)

[Delete Page](#)

[Delete All](#)

Checking images before/after recording

[Auto Review](#)

[Aperture Preview](#)

[Shot. Result Preview](#)

[Live View Display](#)

Monitor/viewfinder settings

- [Grid Line](#)
- [FINDER/MONITOR](#)
- [Monitor Brightness](#)
- [Viewfinder Bright.](#)
- [Finder Color Temp.](#)
- [Display Quality](#)
- [Bright Monitoring](#)

Memory card settings

- [Format](#)
- [File Number](#)
- [Display Media Info.](#)
- [Select REC Folder](#)
- [New Folder](#)
- [Folder Name](#)
- [Recover Image DB](#)

Camera settings

- [Audio signals](#)
- [Tile Menu](#)
- [Mode Dial Guide](#)
- [Power Save Start Time](#)
- [Auto Power OFF Temp.](#)
- [NTSC/PAL Selector](#)
- [HDMI Settings: HDMI Resolution](#)
- [HDMI Settings: 24p/60p Output \(movie\) \(Only for 1080 60i compatible models\)](#)
- [HDMI Settings: HDMI Info. Display](#)
- [HDMI Settings: CTRL FOR HDMI](#)
- [USB Connection](#)
- [USB LUN Setting](#)
- [USB Power Supply](#)

[PC Remote Settings: Still Img. Save Dest.](#)

[PC Remote Settings: RAW+J PC Save Img](#)

[Language](#)

[Date/Time Setup](#)

[Area Setting](#)

[Version](#)

[Demo Mode](#)

Initializing the camera

[Setting_Reset](#)

Using network functions

Connecting this product and a Smartphone

[Imaging_Edge Mobile](#)

[Ctrl w/ Smartphone](#)

[Controlling the camera using a smartphone \(NFC One-touch remote\)](#)

[Controlling the camera using an Android smartphone \(QR Code\)](#)

[Controlling the camera using an Android smartphone \(SSID\)](#)

[Controlling the camera using an iPhone or iPad \(QR Code\)](#)

[Controlling the camera using an iPhone or iPad \(SSID\)](#)

Transferring images to a Smartphone

[Send to Smartphone Func.: Send to Smartphone](#)

[Send to Smartphone Func.: Sending Target \(proxy movies\)](#)

[Sending images to a smartphone \(NFC One-touch Sharing\)](#)

Reading location information from a smartphone

[Location Info. Link Set.](#)

Using a remote commander with Bluetooth communication

[Bluetooth Rmt Ctrl](#)

Transferring images to a TV

[View on TV](#)

Changing the network settings

[Airplane Mode](#)

- [Wi-Fi Settings: WPS Push](#)
- [Wi-Fi Settings: Access Point Set.](#)
- [Wi-Fi Settings: Disp MAC Address](#)
- [Wi-Fi Settings: SSID/PW Reset](#)
- [Bluetooth Settings](#)
- [Edit Device Name](#)
- [Reset Network Set.](#)

Using a computer

[Recommended computer environment](#)

Importing images for use on a computer

- [PlayMemories Home](#)
- [Installing PlayMemories Home](#)
- [Connecting to a computer](#)
- [Importing images to the computer without using PlayMemories Home](#)
- [Disconnecting the camera from the computer](#)

Transferring images to a computer

- [Send to Computer](#)

Developing RAW images/Remote shooting (Imaging Edge)

- [Imaging Edge](#)

Creating a movie disc

- [Selecting a disc to be created](#)
- [Creating Blu-ray Discs from high-definition image quality movies](#)
- [Creating DVD discs \(AVCHD recording discs\) from high-definition image quality movies](#)
- [Creating DVD discs from standard image quality movies](#)

List of MENU items

[Using MENU items](#)

Camera Settings1

- [File Format \(still image\)](#)
- [JPEG Quality \(still image\)](#)

- [JPEG Image Size \(still image\)](#)

- [Aspect Ratio \(still image\)](#)

- [Panorama: Size](#)

- [Panorama: Direction](#)

- [Long Exposure NR \(still image\)](#)

- [High ISO NR \(still image\)](#)

- [Color Space \(still image\)](#)

- [Lens Comp.](#)

- [Switching the auto mode \(Auto Mode\)](#)

- [Scene Selection](#)

- [Superior Auto Img. Extract.](#)

- [Drive Mode](#)

- [Bracket Settings](#)

- [Interval Shoot Func.](#)

- [Recall \(Camera Settings1/Camera Settings2\)](#)

- [Memory \(Camera Settings1/Camera Settings2\)](#)

- [Focus Mode](#)

- [Focus Area](#)

- [AF Illuminator \(still image\)](#)

- [Face/Eye AF Set.](#)

- [AF w/ shutter \(still image\)](#)

- [Pre-AF \(still image\)](#)

- [Eye-Start AF \(still image\)](#)

- [AF Area Auto Clear](#)

- [Disp. cont. AF area](#)

- [AF Micro Adj.](#)

- [Exposure Comp.](#)

- [ISO](#)

- [Metering Mode](#)

- [Face Priority in Multi Metering](#)

- [Exposure step](#)
- [AEL w/ shutter \(still image\)](#)
- [Flash Mode](#)
- [Flash Comp.](#)
- [Exp.comp.set](#)
- [Wireless Flash](#)
- [Red Eye Reduction](#)
- [White Balance](#)
- [Priority Set in AWB](#)
- [D-Range Optimizer \(DRO\)](#)
- [Auto HDR](#)
- [Creative Style](#)
- [Picture Effect](#)
- [Soft Skin Effect \(still image\)](#)
- [Focus Magnifier](#)
- [Focus Magnif. Time](#)
- [Initial Focus Mag_\(still image\)](#)
- [AF in Focus Mag_\(still image\)](#)
- [MF Assist \(still image\)](#)
- [Peaking Setting](#)
- [Face Registration \(New Registration\)](#)
- [Face Registration \(Order Exchanging\)](#)
- [Face Registration \(Delete\)](#)
- [Regist. Faces Priority](#)
- [Smile Shutter](#)
- [Auto Object Framing \(still image\)](#)
- [Self-portrait/ -timer](#)

Camera Settings2

- [Movie: Exposure Mode](#)
- [S&Q Motion: Exposure Mode](#)

- [File Format \(movie\)](#)
- [Record Setting \(movie\)](#)
- [S&Q Settings](#)
- [Proxy Recording](#)
- [AF drive speed \(movie\)](#)
- [AF Tracking Sens. \(movie\)](#)
- [Auto Slow Shutter \(movie\)](#)
- [Initial Focus Mag. \(movie\)](#)
- [Audio Recording](#)
- [Audio Rec Level](#)
- [Audio Level Display](#)
- [Wind Noise Reduct.](#)
- [Marker Display \(movie\)](#)
- [Marker Settings \(movie\)](#)
- [Movie w/ shutter](#)
- [Silent Shooting \(still image\)](#)
- [e-Front Curtain Shutter](#)
- [Release w/o Lens](#)
- [Release w/o Card](#)
- [SteadyShot](#)
- [Clear Image Zoom/Digital Zoom \(Zoom\)](#)
- [Zoom Setting](#)
- [DISP Button \(Monitor/Finder\)](#)
- [FINDER/MONITOR](#)
- [Zebra Setting](#)
- [Grid Line](#)
- [Exposure Set. Guide](#)
- [Live View Display](#)
- [Auto Review](#)
- [Assigning frequently used functions to buttons \(Custom Key\)](#)

[Using Fn \(Function\) button \(Function menu\)](#)

[Dial/Wheel Setup](#)

[Dial/Wheel Ev Comp](#)

[Func. of Touch Operation: Touch Shutter](#)

[Func. of Touch Operation: Touch Focus](#)

[Func. of Touch Operation: Touch Tracking](#)

[MOVIE Button](#)

[Dial / Wheel Lock](#)

[Audio signals](#)

Network

[Send to Smartphone Func.: Send to Smartphone](#)

[Send to Smartphone Func.: Sending Target \(proxy movies\)](#)

[Send to Computer](#)

[View on TV](#)

[Ctrl w/ Smartphone](#)

[Airplane Mode](#)

[Wi-Fi Settings: WPS Push](#)

[Wi-Fi Settings: Access Point Set.](#)

[Wi-Fi Settings: Disp MAC Address](#)

[Wi-Fi Settings: SSID/PW Reset](#)

[Bluetooth Settings](#)

[Location Info. Link Set.](#)

[Bluetooth Rmt Ctrl](#)

[Edit Device Name](#)

[Reset Network Set.](#)

Playback

[Protecting images \(Protect\)](#)

[Rotating an image \(Rotate\)](#)

[Deleting multiple selected images \(Delete\)](#)

[Rating](#)

- [Rating Set\(Custom Key\)](#)
- [Specifying images to be printed \(Specify Printing\)](#)
- [Photo Capture](#)
- [Enlarging an image being played back \(Enlarge Image\)](#)
- [Enlarge Initial Mag.](#)
- [Enlarge Initial Position](#)
- [Cont. PB for Interval](#)
- [PB Speed for Interval](#)
- [Playing back images using slideshow \(Slide Show\)](#)
- [Switching between still images and movies \(View Mode\)](#)
- [Playing back images on the image index screen \(Image Index\)](#)
- [Display as Group](#)
- [Rotating recorded images automatically \(Display Rotation\)](#)
- [Setting the method for jumping between images \(Image Jump Setting\)](#)

Setup

- [Monitor Brightness](#)
- [Viewfinder Bright.](#)
- [Finder Color Temp.](#)
- [Volume Settings](#)
- [Tile Menu](#)
- [Mode Dial Guide](#)
- [Delete confirm.](#)
- [Display Quality](#)
- [Power Save Start Time](#)
- [Auto Power OFF Temp.](#)
- [NTSC/PAL Selector](#)
- [Cleaning Mode](#)
- [Touch Operation](#)
- [Touch Panel/Pad](#)
- [Touch Pad Settings](#)

- [Demo Mode](#)
- [HDMI Settings: HDMI Resolution](#)
- [HDMI Settings: 24p/60p Output \(movie\) \(Only for 1080 60i compatible models\)](#)
- [HDMI Settings: HDMI Info. Display](#)
- [HDMI Settings: CTRL FOR HDMI](#)
- [4K Output Select \(movie\)](#)
- [USB Connection](#)
- [USB LUN Setting](#)
- [USB Power Supply](#)
- [PC Remote Settings: Still Img. Save Dest.](#)
- [PC Remote Settings: RAW+J PC Save Img](#)
- [Language](#)
- [Date/Time Setup](#)
- [Area Setting](#)
- [Format](#)
- [File Number](#)
- [Select REC Folder](#)
- [New Folder](#)
- [Folder Name](#)
- [Recover Image DB](#)
- [Display Media Info.](#)
- [Version](#)
- [Setting Reset](#)

My Menu

- [Add Item](#)
- [Sort Item](#)
- [Delete Item](#)
- [Delete Page](#)
- [Delete All](#)

Precautions/This product

[Precautions](#)

[On cleaning](#)

Cleaning the image sensor

└ [Cleaning Mode](#)

[Number of recordable images](#)

[Recordable movie times](#)

[Using the AC Adaptor/battery charger abroad](#)

[AVCHD format](#)

[License](#)

[Specifications](#)

[Trademarks](#)

If you have problems

[Troubleshooting](#)

[Warning messages](#)

Interchangeable Lens Digital Camera
 ILCE-6100 α6100

Identifying parts

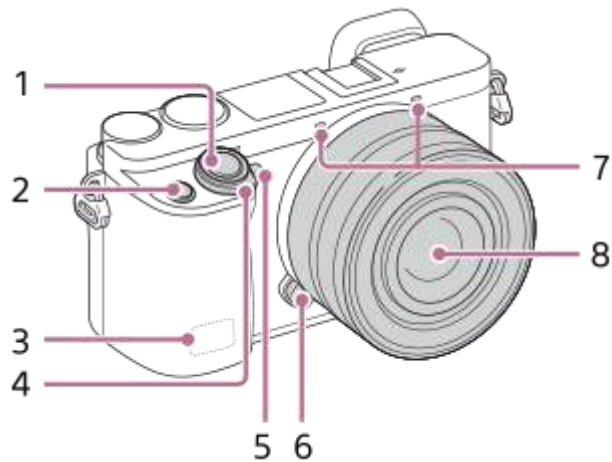

When the lens is removed

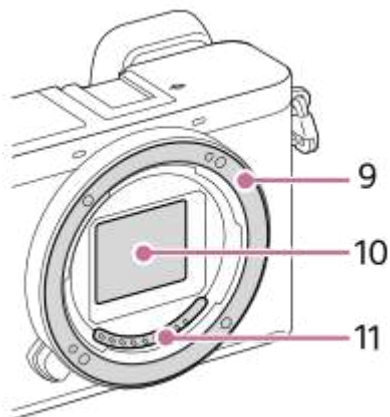

1. Shutter button
2. C1 button (Custom button 1)
3. Wi-Fi/ Bluetooth antenna (built-in)
4. ON/OFF (Power) switch
5. Self-timer lamp/AF illuminator
6. Lens release button
7. Microphone*
8. Lens
9. Mount
10. Image sensor**
11. Lens contacts**

* Do not cover this part during movie recording. Doing so may cause noise or lower the volume.

** Do not directly touch these parts.

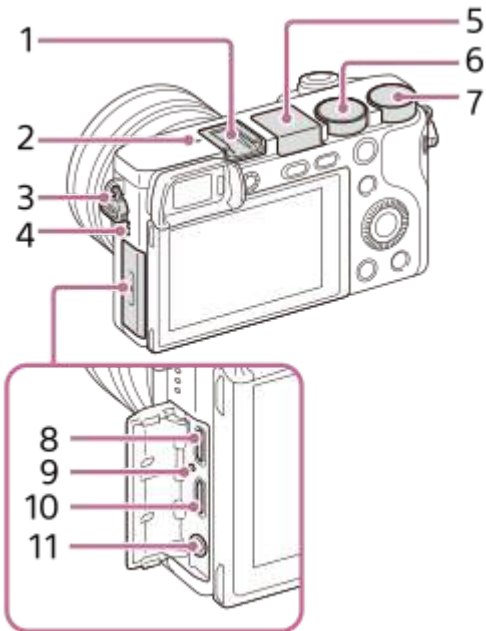

1. Multi Interface Shoe*

2.  Image sensor position mark

- The image sensor is the sensor that converts light into an electric signal. The  mark shows the location of the image sensor. When you measure the exact distance between the camera and the subject, refer to the position of the horizontal line.

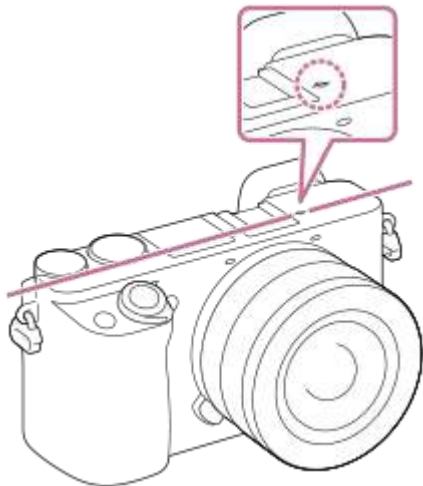

- If the subject is closer than the minimum shooting distance of the lens, the focus cannot be confirmed. Make sure you put enough distance between the subject and the camera.

3. Hooks for shoulder strap

Attach both ends of the strap onto the camera.

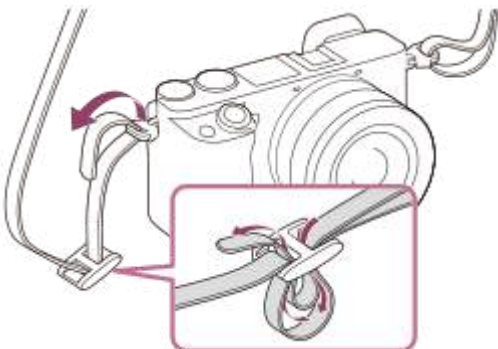

4. Speaker

5. Flash

- Press the ⚡ (Flash pop-up) button to use the flash. The flash does not pop up automatically.
- When not using the flash, press it back into the camera body.

6. Mode dial

7. Control dial

8. Multi/Micro USB Terminal*

This terminal supports Micro USB-compatible devices.

9. Charge lamp

10. HDMI micro jack

11.  (Microphone) jack

When an external microphone is connected, the built-in microphone turns off automatically. When the external microphone is a plugin-power type, the power of the microphone is supplied by the camera.

* For details on compatible accessories for the multi interface shoe and the Multi/Micro USB Terminal, visit the Sony website, or consult your Sony dealer or local authorized Sony service facility. Accessories for the Accessory Shoe can also be used. Operations with other manufactures' accessories are not guaranteed.

Multi Interface Shoe

Accessory Shoe

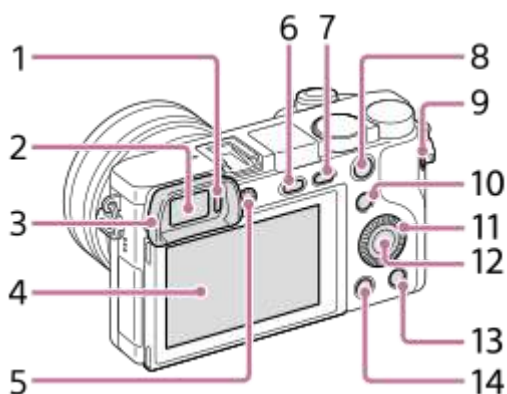

1. Eye sensor

2. Viewfinder

3. Eyepiece Cup

- Not attached to the camera at the factory. It is recommended that you attach the eyepiece cup when you intend to use the viewfinder.

Attaching/removing the eyepiece cup

Match the bottom side of the eyepiece cup to the viewfinder, and attach it by pushing the top side of the eyepiece cup in.

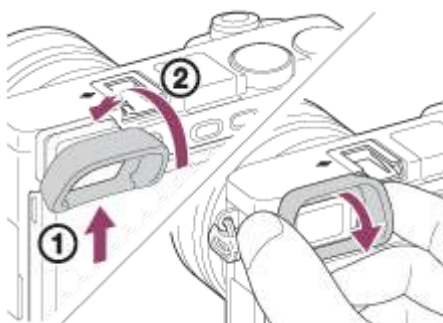

To remove the eyepiece cup, grasp it on the left and right sides and pull it down.

- Remove the eyepiece cup when you attach an accessory (sold separately) to the Multi Interface Shoe.

4. Monitor

- You can change the monitor angle to shoot from any position you like.
High position (holding the camera high)

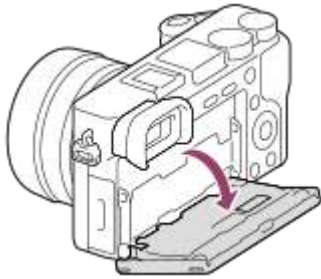

Low position (holding the camera low)

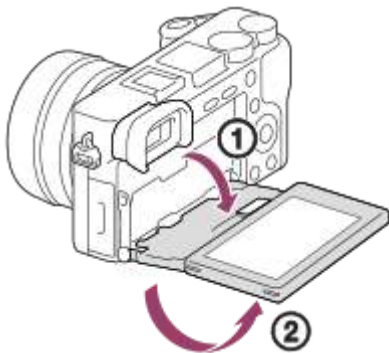

Selfie position (facing the monitor toward you to take a selfie)

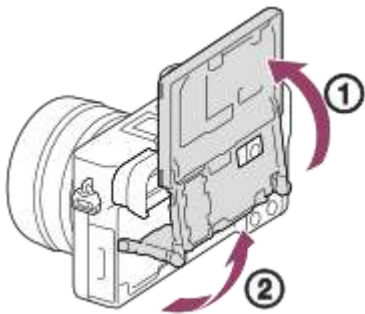

- You may not be able to adjust the monitor angle depending on the type of a tripod you use. In such a case, release the tripod screw once to adjust the monitor angle.



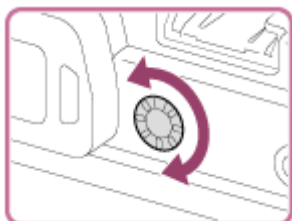

5. Diopter-adjustment dial

- Adjust the diopter-adjustment dial to your eyesight until the display appears clearly in the viewfinder. If it is difficult to turn the diopter-adjustment dial, remove the eyepiece cup and then adjust the dial.





6. ⚡ (Flash pop-up) button

7. MENU button

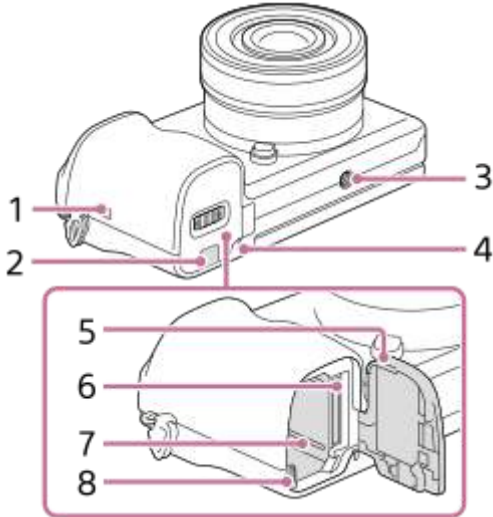
8. For shooting: AEL button
For viewing:  (Enlarge) button
9. MOVIE (Movie) button
10. For shooting: Fn (Function) button
For viewing:  (Send to Smartphone) button
You can display the screen for [Send to Smartphone] by pressing this button.
11. Control wheel
12. Center button
13. C2 button (Custom button 2)/  (Delete) button
14.  (Playback) button



1.  (N-Mark)

- Touch the mark when you connect the camera to a smartphone equipped with the NFC function. For details on the location of the  (N-Mark) on your Smartphone, refer to the operating instructions of the Smartphone.

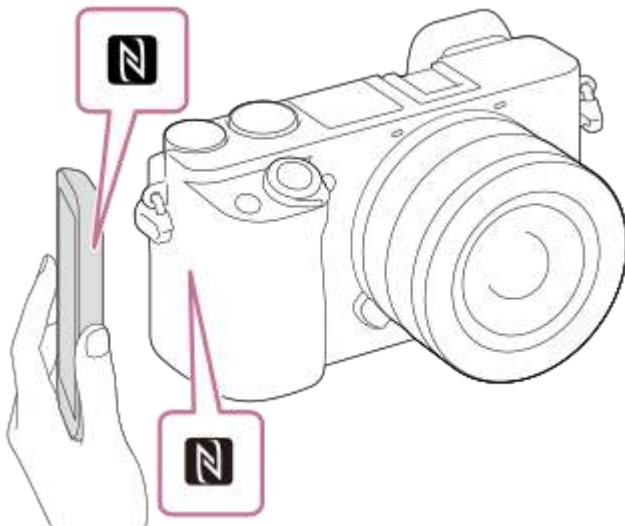

- NFC (Near Field Communication) is an international standard of the short-range wireless communication technology.

2. Connection plate cover

- Use this when using an AC-PW20 AC Adaptor (sold separately). Insert the connection plate into the battery compartment, and then pass the cord through the connection plate cover as shown below.

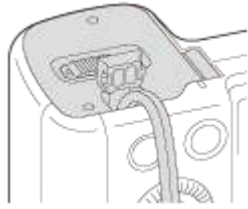

- Make sure that the cord is not pinched when you close the cover.

3. Tripod socket hole

Use a tripod with a screw less than 5.5 mm (7/32 inches) long. Otherwise, you cannot firmly secure the camera, and damage to the camera may occur.

4. Access lamp

5. Battery/memory card cover

6. Memory card slot





7. Battery insertion slot

8. Battery lock lever

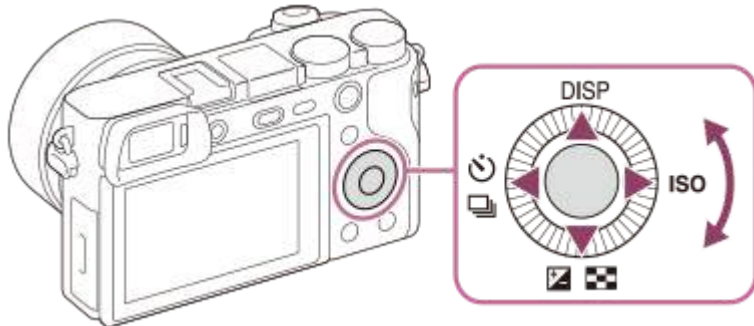
Interchangeable Lens Digital Camera
ILCE-6100 α6100

Using the control wheel



- You can select setting items by turning or pressing the top/bottom/left/right side of the control wheel. Your selection is determined when you press the center of the control wheel.
- The default settings for the top/bottom/left/right side and the center of the control wheel are as follows.
 - Top side: DISP (Display Setting)
 - Bottom side: Exposure Comp./Image Index ( / )
 - Left side: Drive Mode ( / )
 - Right side: ISO
 - Center: Eye AFYou can also assign the desired functions to the bottom/left/right side and the center of the control wheel.
- During playback, you can display the next/previous image by pressing the right/left side of the control wheel or by turning the control wheel.

Related Topic

- [Focus Standard](#)
- [Assigning frequently used functions to buttons \(Custom Key\)](#)

Using MENU items

You can change settings related to all the camera operations including shooting, playback, and operating method. You can also execute camera functions from the MENU.

- 1 Press the MENU button to display the menu screen.

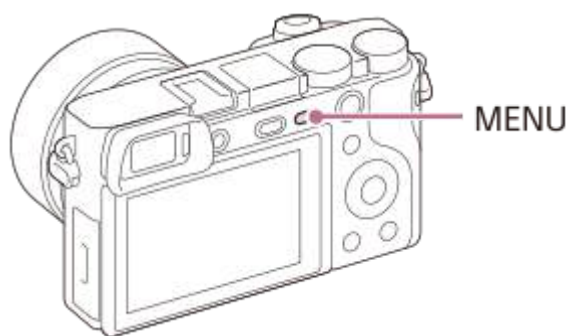

- 2 Select the desired setting you want to adjust using the top/bottom/left/right sides of the control wheel or by turning the control wheel, and then press the center of the control wheel.

- Select a MENU tab (A) at the top of the screen, and press the left/right side of the control wheel to move to another MENU tab.
- You can go back to the previous screen by pressing the MENU button.





- 3 Select the desired setting value, and press the center to confirm your selection.

Related Topic

- [Tile Menu](#)
- [Add Item](#)

Assigning frequently used functions to buttons (Custom Key)

You can use the custom key function to assign the functions you use most frequently to easily operable keys. This lets you skip the process of selecting items from MENU, so you can recall the functions more quickly. You can also assign [Not set] to easily operable keys to prevent accidental operation.

You can separately assign functions to custom keys for the still image shooting mode ( Custom Key), movie shooting mode ( Custom Key), and playback mode ( Custom Key).

- Assignable functions vary depending on the keys.

You can assign functions to the following keys.

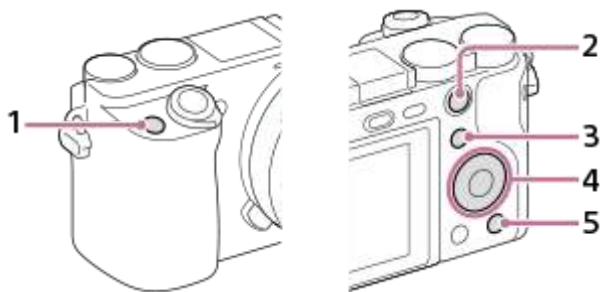





1. Custom Button 1
2. AEL Button
3. Fn/  Button
4. Center Button /Left Button/Right Button/Down Button
5. Custom Button 2

For details on functions that can be assigned to custom keys, refer to the following URL:
<https://support.d-imaging.sony.co.jp/support/tutorial/ilc//ilce-6100/custom.php>







Hint

- You can recall functions more quickly by using the Function menu to configure each setting directly from the Fn button, along with the custom keys. Refer to the related functions under “Related Topic” at the bottom of this page.

The following is the procedure for assigning the [Eye AF] function to the AEL button.

- 1 MENU →  2 (Camera Settings2) → [ Custom Key].**
 - If you want to assign a function to recall while shooting movies, select [ Custom Key]. If you want to assign a function to recall while playing back images, select [ Custom Key].
- 2 Move to the [Rear1] screen using the left/right side of the control wheel. Then, select [AEL Button] and press the center of the control wheel.**
- 3 Press the left/right side of the control wheel until [Eye AF] is displayed. Select [Eye AF], and then press the center.**
 - If you press the AEL button in the still image shooting mode and eyes are detected, [Eye AF] will activate, and the camera will focus on the eyes. Shoot images while holding down the AEL button.

Note

- You can also assign shooting functions to the focus hold button on the lens. However, some lenses do not have a focus hold button.
- If you assign [Follow Custom ()] to a custom key using [ Custom Key], but the function is one that is unavailable in the movie shooting mode such as [ JPEG Quality] or [Flash Mode], the function will not be recalled when you press the key in the movie shooting mode.
- If you assign [Follow Custom ( / )] to a custom key using [ Custom Key], the camera will switch to the shooting mode and recall the assigned function when you press the key in the playback mode.

Related Topic

- [Using Fn \(Function\) button \(Function menu\)](#)

Interchangeable Lens Digital Camera
ILCE-6100 α6100

Using Fn (Function) button (Function menu)

The Function menu is a menu of 12 functions that is displayed at the bottom of the screen when you press the Fn (Function) button in the shooting mode. You can access frequently used functions more quickly by registering them to the function menu.

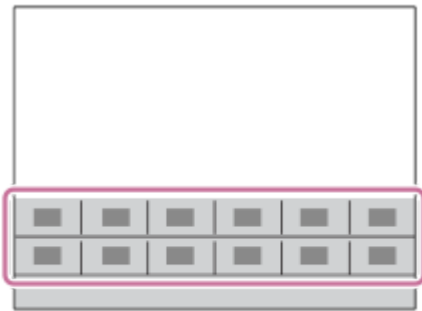

For details on functions that can be registered to the function menu, refer to the following URL:
<https://support.d-imaging.sony.co.jp/support/tutorial/ilc//ilce-6100/function.php>

Hint

- You can recall functions more quickly by using the custom key function to assign frequently used functions to desired keys, along with the function menu. Refer to the related functions under "Related Topic" at the bottom of this page.

- 1 Press the DISP on the control wheel repeatedly to display a screen mode other than [For viewfinder], and then press the Fn (Function) button.

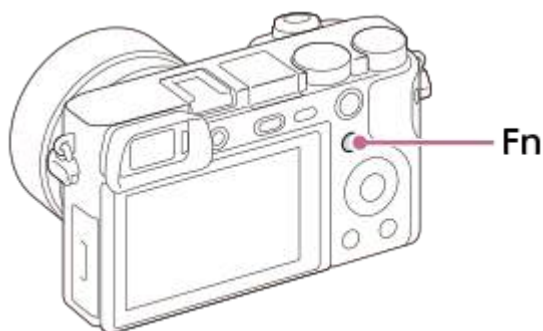

- 2 Select the desired function by pressing the top/bottom/left/right side of the control wheel.

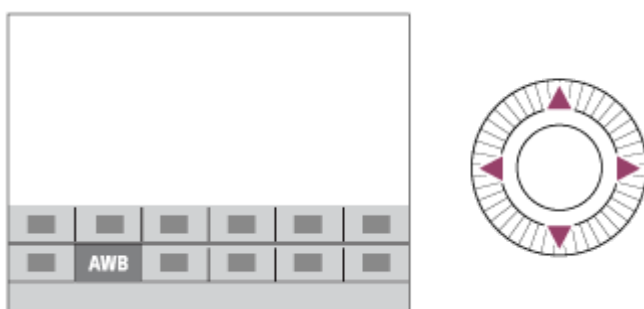

3 Select the desired setting by turning the control wheel, and press the center of the control wheel.

- Some functions can be fine-tuned using the control dial.

To adjust settings from the dedicated setting screens

Select the desired function in step 2, then press the center of the control wheel. The dedicated setting screen for the function will appear. Follow the operating guide **(A)** to adjust settings.

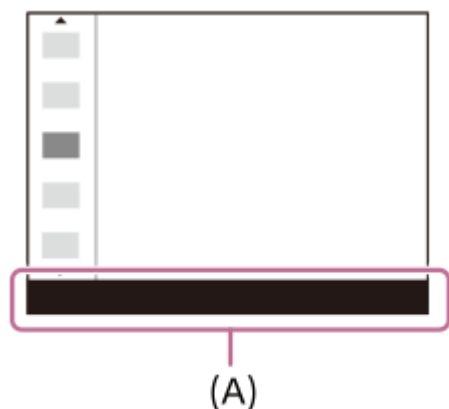

To change the functions in the function menu (Function Menu Set.)

The following is the procedure for changing [Drive Mode] in the function menu to [Grid Line].

1. MENU → 2 (Camera Settings2) → [Function Menu Set.].
2. Select (Drive Mode) from among the twelve functions in the function menu using the top/bottom/left/right side of the control wheel, and then press the center.
3. Move to the [Display/Auto Review] screen using the left/right side of the control wheel. Then, select [Grid Line] and press the center of the control wheel.
 - (Grid Line) will be displayed in the former location of (Drive Mode) in the function menu.

Related Topic

- [Assigning frequently used functions to buttons \(Custom Key\)](#)

How to use the Quick Navi screen

The Quick Navi screen is a function optimized for shooting with the viewfinder, that lets you control settings directly.

- 1 MENU → 2 (Camera Settings2) → [DISP Button] → [Monitor].
- 2 Place a ✓ mark on [For viewfinder] and then select [Enter].
- 3 Press the DISP on the control wheel to set the screen mode to [For viewfinder].
- 4 Press the Fn button to switch to the Quick Navi screen.
 - The displayed contents and their positions in the illustrations are just guidelines, and may differ from the actual displays.

Auto mode/Scene Selection mode



P/A/S/M/Sweep Panorama mode



- 5 Select the desired function by pressing the top/bottom/left/right side of the control wheel.
- 6 Turn the control wheel to select the desired setting.
 - Some functions can be fine-tuned using the control dial.

To adjust settings from the dedicated setting screens

Select the desired function in step 5, then press the center of the control wheel. The dedicated setting screen for the function will appear. Follow the operating guide **(A)** to adjust settings.

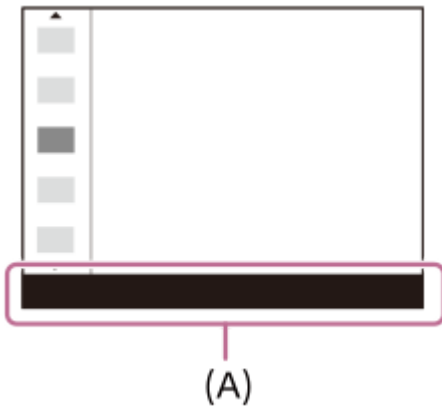

Note

- Items that are gray on the Quick Navi screen are not adjustable.
- When using [Creative Style], etc., some of the setup tasks can only be accomplished on a dedicated screen.

Related Topic

- [Switching the screen display \(while shooting/during playback\)](#)

How to use the keyboard

When manual character entry is required, a keyboard is displayed on the screen.



Move the cursor on desired key using the control wheel, then press the center to enter.

1. Input box

The characters you entered are displayed.

2. Switch character types

Each time you press this key, the character type will switch between alphabet letters, numerals and symbols.

3. Keyboard

Each time you press this key, the characters corresponding to that key will be displayed one-by-one in order.

For example: If you want to enter “abd”

Press the key for “abc” once to display “a” → select “”((5) Move cursor) and press the key for “abc” twice to display “b” → press the key for “def” once to display “d.”

4. Finalize

Finalizes the entered characters.

5. Move cursor

Moves the cursor in the input box to the right or left.

6. Delete

Deletes the character preceding the cursor.

7.

Switches the next character to a capital or lowercase letter.

8.

Enters a space.

- To cancel input, select [Cancel].

Interchangeable Lens Digital Camera
 ILCE-6100 α6100

List of icons on the monitor

The displayed contents and their positions in the illustrations are just guidelines, and may differ from the actual displays. Descriptions are given below the indications of the icons.

Icons on the shooting screen

Monitor mode

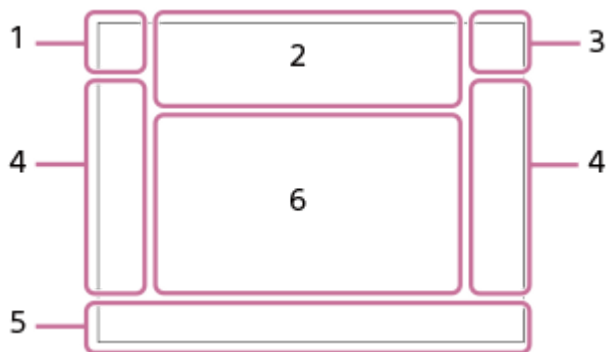

Viewfinder mode

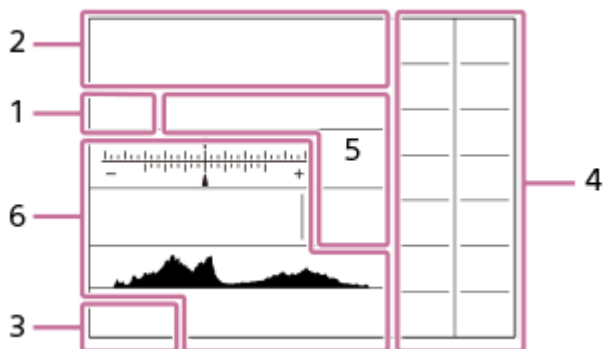

1. Shooting mode/Scene recognition

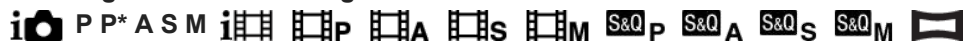

Shooting mode



Register number



Scene Recognition icons



Scene Selection

2. Camera settings



Memory card status

100/1 h 30 m

Remaining number of recordable images/Recordable time of movies



Writing data / Number of images left to write

3:2 16:9 1:1

Aspect ratio of still images

24M / 20M / 16M / 12M / 10M / 8.0M / 6.0M / 5.1M / 4.0M

Image size of still images

RAW

RAW recording

X.FINE FINE STD

JPEG Quality

XAVC S 4K XAVC S HD AVCHD

File format of movies

100 60 50 25 16 FX FH

Record setting of movies

120p 60p 60i 30p 24p 100p 50p 50i 25p

Frame rate of movies

100p 60p 50p 25p 16p

Proxy Recording

120fps 60fps 30fps 15fps 8fps 4fps 100fps 50fps 25fps 12fps 6fps 3fps 2fps 1fps

Frame rate for slow/quick motion shooting



Flash charge in progress

VIEW

Setting Effect OFF



AF Illuminator



SteadyShot off/on, Camera shake warning



Smart Zoom/ Clear Image Zoom/Digital Zoom

-PC-

PC remote



Bright Monitoring



Silent Shooting



Remote control



No audio recording of movies



Wind Noise Reduct.



Touch Shutter



Focus Cancel



Tracking Cancel

Spot Focus

Performing [Spot Focus]



NFC active



Bluetooth connection available / Bluetooth connection unavailable



Connected to smartphone / Not connected to smartphone



Obtaining location information / Location information cannot be obtained



Airplane Mode



Overheating warning



Database file full / Database file error

3. Battery

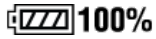

Remaining battery



Remaining battery warning



USB power supply

4. Shooting settings

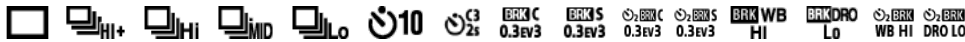

Drive Mode



Flash Mode /Wireless Flash/Red Eye Reduction



Flash Comp.



Focus Mode



Focus Area



File Format



Metering Mode



White Balance (Auto, Preset, Underwater Auto, Custom, Color temperature, Color filter)



D-Range Optimizer /Auto HDR



Creative Style /Contrast, saturation, and sharpness

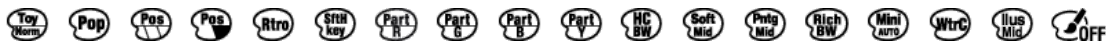

Picture Effect



Face/Eye Priority in AF



Soft Skin Effect



Smile detection sensitivity indicator

5. Focus indicator/exposure settings



Focus indicator

1/250

Shutter speed

F3.5

Aperture value



Exposure compensation/Metered Manual

ISO400

ISO AUTO



ISO sensitivity



AE lock/FEL lock

6. Guides/other



Guide display for tracking

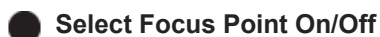

Guide display for setting Focus Area

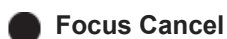

Guide display for canceling focusing



Control wheel function



Control dial function



Bracket indicator



Spot metering area



Exposure Setting Guide



Shutter speed indicator



Aperture indicator



Histogram

STBY REC

Movie recording standby/Movie recording in progress

1:00:12

Actual movie recording time (hours: minutes: seconds)



Audio Level Display

Icons on the playback screen

Single-image playback

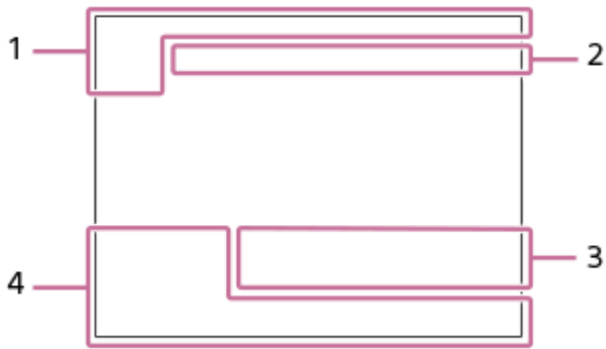

Histogram display

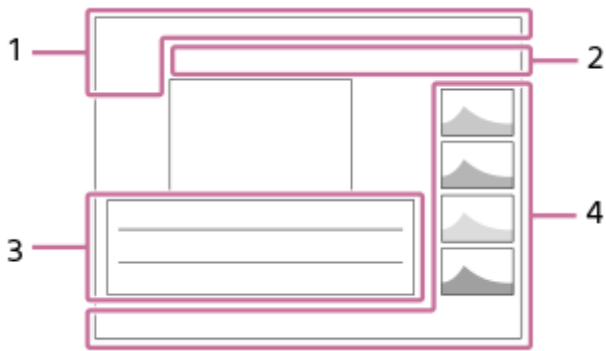

1. Basic information



View Mode



Rating



Protect

DPOF

DPOF set



Auto object framing image

3/7

File number/Number of images in the view mode



NFC active



Remaining battery



Display as Group



Proxy movie included

2. Camera settings

Refer to "Icons on the shooting screen."

3. Shooting settings



Picture Effect error



Auto HDR error

35mm

Lens focal length

Refer to “Icons on the shooting screen” for other icons displayed in this area.

4. Image information



Latitude/longitude information

2019 -1-1 10:37PM

Date of recording



100-0003

Folder number - file number



Histogram (Luminance/R/G/B)

Switching the screen display (while shooting/during playback)

You can change the display contents on the screen.

1 Press the DISP (Display Setting) button.

- To switch the information displayed on the viewfinder, press the DISP button while looking into the viewfinder.
- Each time you press the DISP button, the screen display changes.
- The displayed contents and their position are just a guideline, and may differ from the actual display.

During shooting (Monitor)

Display All Info. → No Disp. Info. → Histogram → For viewfinder → Display All Info.

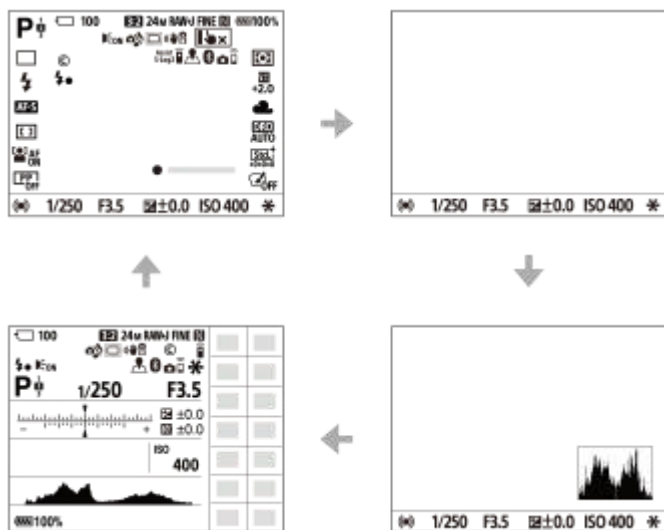

During shooting (Viewfinder)

No Disp. Info. → Histogram → No Disp. Info.



During playback (Monitor/Viewfinder)

Display Info. → Histogram → No Disp. Info. → Display Info.

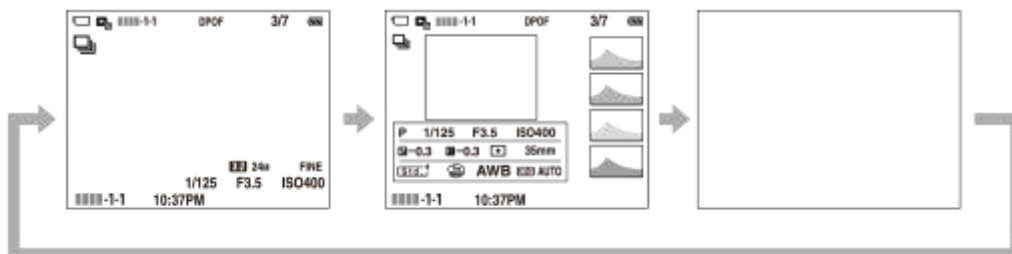

- If the image has an overexposed or underexposed area, the corresponding section will blink on the histogram display (overexposed/underexposed warning).
- The settings for playback are also applied in [Auto Review].

Histogram display

A histogram shows the luminance distribution, displaying how many pixels there are by luminance. It shows darker toward the left and brighter toward the right.

The histogram changes depending on the exposure compensation.

A peak at the right or left end of the histogram indicates that the image has an overexposed or underexposed area, respectively. You cannot correct such defects using a computer after shooting. Perform exposure compensation before shooting as necessary.



(A): Pixel count

(B): Brightness

Note

- The viewfinder display and the monitor display for shooting can be set separately. Look through the viewfinder to set the display settings for the viewfinder.
- [Histogram] is not displayed during panorama shooting.
- The information in the histogram display does not indicate the final photograph. It is information about image displayed on the screen. The final result depends on the aperture value, etc.
- The histogram display is extremely different between shooting and playback in the following cases:
 - When the flash is used
 - When shooting a low luminance subject such as a night scene
- In movie mode, [For viewfinder] cannot be displayed.

Hint

- The following are not displayed in the default settings.
 - Graphic Display
 - Monitor Off
 - Display All Info. (when using the viewfinder)

To change the display modes that are switched when you press the DISP button, select MENU →  2 (Camera Settings2) → [DISP Button] and change the setting.

Related Topic

- [DISP Button \(Monitor/Finder\)](#)

5-009-879-12(1) Copyright 2019 Sony Corporation

Interchangeable Lens Digital Camera
ILCE-6100 α6100

DISP Button (Monitor/Finder)

Allows you to set the screen display modes that can be selected using DISP (Display Setting) in shooting mode.

1 MENU →  2 (Camera Settings2) → [DISP Button] → [Monitor] or [Finder] → desired setting → [Enter].

The items marked with ✓ are available.

Menu item details

Graphic Display :

Shows basic shooting information. Graphically shows the shutter speed and aperture value.

Display All Info. :

Shows recording information.

No Disp. Info. :

Does not show recording information.

Histogram :

Displays the luminance distribution graphically.

For viewfinder*:

Displays only shooting information on the monitor, not the subject. This setting is a display setting for shooting with the viewfinder.

Monitor Off*:

Always turns the monitor off when shooting images. You can use the monitor when playing back images or operating MENU. This setting is a display setting for shooting with the viewfinder.

* These screen modes are available only in the setting for [Monitor].

Related Topic

- [Switching the screen display \(while shooting/during playback\)](#)

Interchangeable Lens Digital Camera
ILCE-6100 α6100

Checking the camera and the supplied items

The number in parentheses indicates the number of pieces.

- Camera (1)
- AC Adaptor (1)
The type of the AC Adaptor may differ depending on the country/region.
- NP-FW50 Rechargeable Battery Pack (1)

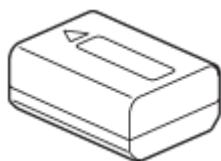

- Micro USB cable (1)

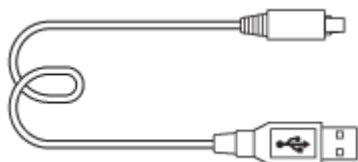

- Shoulder Strap (1)

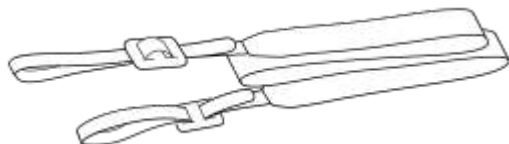

- Body Cap (1)
Only for the ILCE-6100



- Eyepiece Cup (1)



- Startup Guide (1)
- Reference Guide (1)

Interchangeable Lens Digital Camera
ILCE-6100 α6100

E PZ 16–50mm F3.5–5.6 OSS (Power zoom)

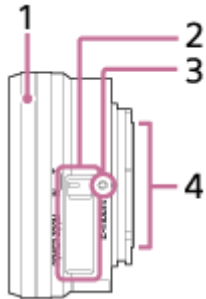

1. Zooming/Focusing ring
2. Zooming lever
3. Mounting index
4. Lens contacts*

* Do not touch this part directly.

Specifications

Focal length: 16 mm – 50 mm

Equivalent 35 mm-format focal length^{*1}: 24 – 75 mm

Lens groups – elements: 8 – 9

Angle of view^{*1}: 83° – 32°

Minimum focus^{*2}: 0.25 – 0.3 m (0.82 – 1 ft.)

Maximum magnification: 0.215×

Minimum aperture: f/22 – f/36

Filter diameter: 40.5 mm

Dimensions (max. diameter × height): Approx. 64.7 mm × 29.9 mm (Approx. 2 5/8 inches × 1 3/16 inches)

Mass: Approx. 116 g (Approx. 4.1 oz.)

SteadyShot: Available

*1 The values for equivalent 35 mm-format focal length and angle of view are based on digital cameras equipped with an APS-C sized image sensor.

*2 Minimum focus is the shortest distance from the image sensor to the subject.

Supplied items

Lens (1), Front Lens Cap (1)

Interchangeable Lens Digital Camera
ILCE-6100 α6100

E 55-210 mm F4.5-6.3 OSS (supplied with ILCE-6100Y)

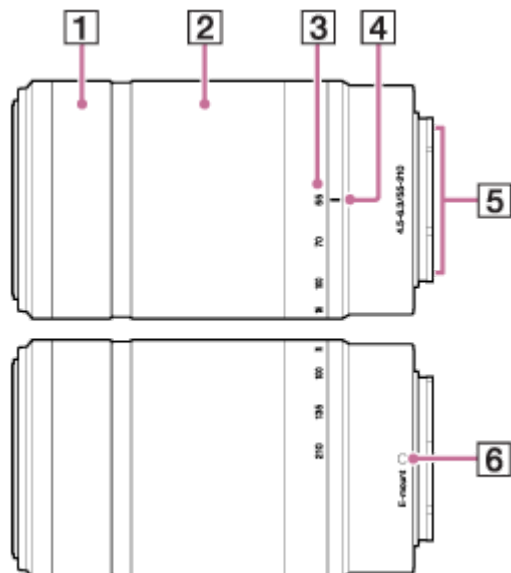

1. Focusing ring
2. Zooming ring
3. Focal-length scale
4. Focal-length index
5. Lens contacts*
6. Mounting index

* Do not touch this part directly.

Specifications

Focal length: 55 mm – 210 mm

Equivalent 35 mm-format focal length^{*1}: 82.5 mm – 315 mm

Lens groups – elements: 9 – 13

Angle of view^{*1}: 28.2° – 7.8°

Minimum focus^{*2}: 1.0 m (3.28 ft.)

Maximum magnification: 0.225×

Minimum aperture: f/22 – f/32

Filter diameter: 49 mm

Dimensions (max. diameter × height): Approx. 63.8 mm × 108mm (Approx. 2 5/8 inches × 4 3/8 inches)

Mass: Approx. 345 g (Approx. 12.2 oz.)

SteadyShot: Available

^{*1} The values for equivalent 35 mm-format focal length and angle of view are based on digital cameras equipped with an APS-C sized image sensor.

^{*2} Minimum focus is the shortest distance from the image sensor to the subject.

Supplied items

Lens (1), Front Lens Cap (1), Rear Lens Cap (1), Lens Hood (1)

Inserting/removing the battery pack

- 1 Open the battery/memory card cover.

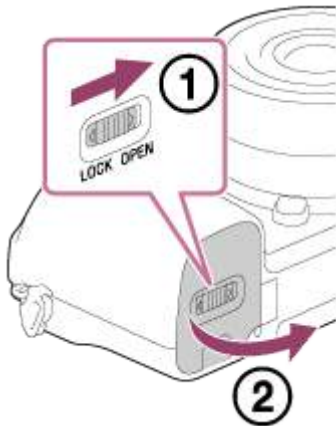

- 2 Insert the battery pack while pressing the lock lever (A) with the tip of the battery until the battery locks into place.

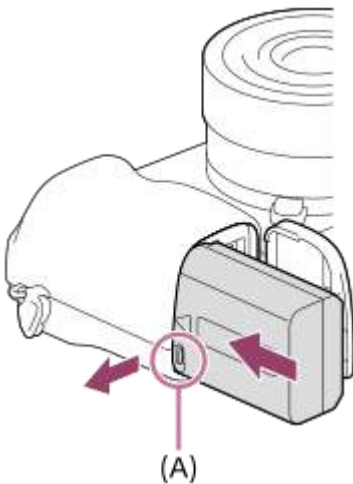

- 3 Close the cover.

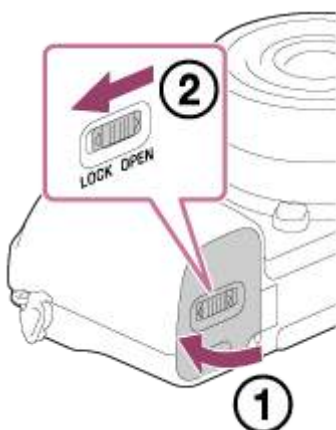

To remove the battery pack

Make sure that the access lamp is not lit, and turn off the camera. Then, slide the lock lever **(A)** and remove the battery pack. Be careful not to drop the battery pack.

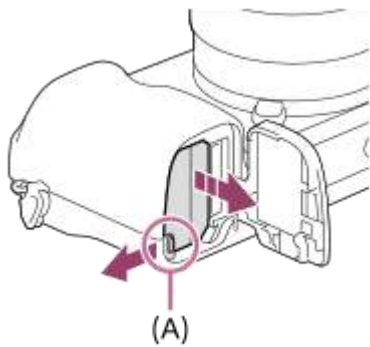

5-009-879-12(1) Copyright 2019 Sony Corporation

Charging the battery pack while it is inserted in the camera

- 1 Turn the power off.
- 2 Connect the camera with the battery pack inserted to the AC Adaptor (supplied) using the micro USB cable (supplied), and connect the AC Adaptor to the wall outlet (wall socket).

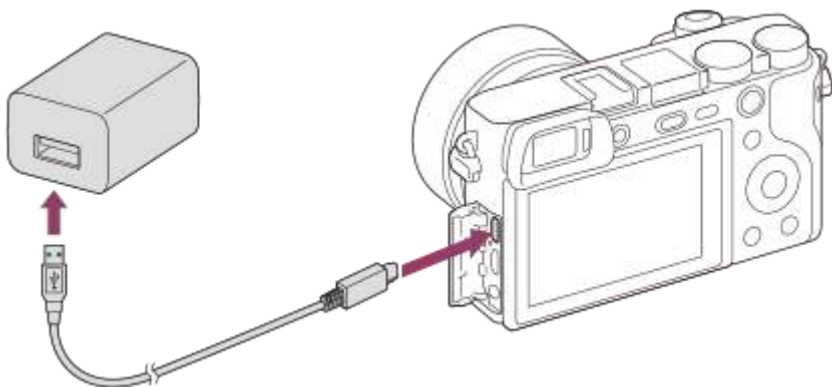

Charge lamp on the camera (orange)

Lit: Charging

Off: Charging finished

Flashing: Charging error or charging paused temporarily because the camera is not within the proper temperature range

- Charging time (Full charge): The charging time is approximately 150 min.
- The above charging time applies when charging a fully depleted battery pack at a temperature of 25 °C (77 °F). Charging may take longer depending on conditions of use and circumstances.
- The charge lamp turns off when charging is completed.
- If the charge lamp lights up and then immediately turns off, the battery pack is fully charged.

Note

- If the charge lamp flashes when the battery pack is not fully charged, remove the battery pack or disconnect the USB cable from the camera and then re-insert it to recharge.
- If the charge lamp on the camera flashes when the AC Adaptor is connected to the wall outlet (wall socket), this indicates that charging is temporarily stopped because the temperature is outside the recommended range. When the temperature gets back within the appropriate range, the charging resumes. We recommend charging the battery pack at an ambient temperature of between 10°C to 30°C (50°F to 86°F).
- Use a nearby wall outlet (wall socket) when using the AC Adaptor/Battery Charger. If any malfunction occurs, disconnect the plug from the wall outlet (wall socket) immediately to disconnect from the power source.
If you use the product with a charge lamp, note that the product is not disconnected from the power source even when the lamp turns off.
- If you turn on the camera, power will be supplied from the wall outlet (wall socket) and you will be able to operate the camera. However, the battery pack will not be charged.
- When you use a completely new battery pack or a battery pack that has not been used for a long time, the charge lamp may flash quickly when the battery is charged. If this happens, remove the battery pack or disconnect the USB cable from the camera and then re-insert it to recharge.

- Do not continuously or repeatedly charge the battery pack without using it if it is already fully charged or close to fully charged. Doing so may cause a deterioration in battery performance.
- When charging is finished, disconnect the AC Adaptor from the wall outlet (wall socket).
- Be sure to use only genuine Sony brand battery packs, USB cables (supplied) and AC Adaptors (supplied).

Related Topic

- [Notes on the battery pack](#)
- [Notes on charging the battery pack](#)
- [Using the AC Adaptor/battery charger abroad](#)

5-009-879-12(1) Copyright 2019 Sony Corporation

Charging by connecting to a computer

The battery pack can be charged by connecting the camera to a computer using a micro USB cable.

- 1 Turn off the product, and connect to the USB terminal of the computer.

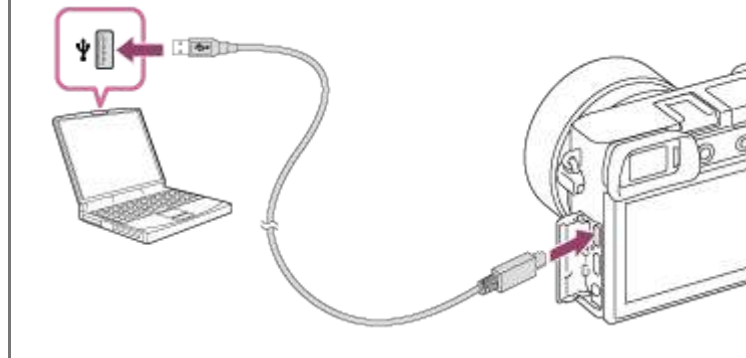

Note

- If the product is connected to a laptop computer that is not connected to a power source, the laptop battery level decreases. Do not leave the product connected to a laptop computer for an extended period of time.
- Do not turn on/off or restart the computer, or wake the computer from sleep mode when a USB connection has been established between the computer and the camera. Doing so may cause a malfunction. Before turning on/off or restarting the computer, or waking the computer from sleep mode, disconnect the camera from the computer.
- Proper operation cannot be guaranteed on all types of computers.
- Charging cannot be guaranteed with a custom-built computer, modified computer, or a computer connected through a USB hub.
- The camera may not operate correctly when other USB devices are used at the same time.

Related Topic

- [Notes on the battery pack](#)
- [Notes on charging the battery pack](#)

Battery life and number of recordable images

		Battery life	Number of images
Shooting (still images)	Screen mode	—	Approx. 420
	Viewfinder mode	—	Approx. 380
Actual shooting (movies)	Screen mode	Approx. 75 min.	—
	Viewfinder mode	Approx. 70 min.	—
Continuous shooting (movies)	Screen mode	Approx. 125 min.	—
	Viewfinder mode	Approx. 125 min.	—

- The above estimates for battery life and number of recordable images apply when the battery pack has been fully charged. The battery life and number of images may decrease depending on the conditions of use.
- The battery life and number of recordable images are estimates based on shooting with the default settings under the following conditions:
 - Using the battery pack at an ambient temperature of 25°C (77°F).
 - Using a Sony SDXC memory card (U3) (sold separately)
 - Using a E PZ 16-50mm F3.5-5.6 OSS lens
- The numbers for “Shooting (still images)” are based on the CIPA standard and shooting under the following conditions:
(CIPA: Camera & Imaging Products Association)
 - One picture is taken every 30 seconds.
 - The power is turned on and off once every ten times.
 - The flash strobes once for every two pictures.
 - The zoom is switched alternately between the W and T ends.
- The number of minutes for movie shooting is based on the CIPA standard and shooting under the following conditions:
 - The image quality is set to XAVC S HD 60p 50M /50p 50M.
 - Actual shooting (movies): Battery life based on repeated shooting, zooming, shooting stand-by, turning on/off, etc.
 - Continuous shooting (movies): No operations other than starting and ending shooting are performed.

Interchangeable Lens Digital Camera
ILCE-6100 α6100

Supplying power from a wall outlet (wall socket)

Use the supplied AC adaptor to shoot and play back images while power is supplied from a wall outlet (wall socket). This conserves the camera's battery power.

- 1 Insert the battery pack into the camera.**
- 2 Connect the camera to the wall outlet (wall socket) with a micro USB cable (supplied) and an AC adaptor (supplied).**

Note

- The camera will not activate if there is no remaining battery. Insert a sufficiently charged battery pack into the camera.
- If you use the camera while power is being supplied from a wall outlet (wall socket), make sure that the icon that shows that powering via USB is in progress () is displayed on the monitor.
- Do not remove the battery pack while power is supplied from a wall outlet (wall socket). If you remove the battery pack, the camera will be turned off.
- Do not remove the battery pack while the access lamp is lit. The data in the memory card may be damaged.
- As long as the power is on, the battery pack will not be charged even if the camera is connected to the AC Adaptor.
- Under certain conditions, power may be supplied from the battery pack supplementarily even if you are using the AC adaptor.
- Do not remove the Micro USB cable while power is supplied from a wall outlet (wall socket). Before you remove the Micro USB cable, turn off the camera.
- Depending on the camera and battery temperature, the continuous recording time may be shortened while power is supplied from a wall outlet (wall socket).
- When using a mobile charger as a power source, confirm that it is fully charged before use. Also, be careful of the remaining power on the mobile charger during use.

Notes on the battery pack

Notes on using the battery pack

- Be sure to use only battery packs specified for this product.
- The correct remaining battery indicator may not be displayed under some operating or environmental conditions.
- Do not expose the battery pack to water. The battery pack is not water-resistant.
- Do not leave the battery pack in extremely hot places, such as in a car or under direct sunlight.

Charging the battery pack

- Charge the battery pack (supplied) before using the product for the first time.
- The charged battery pack will discharge little by little even if you do not use it. Charge the battery pack each time before you use the product so that you do not miss any opportunities to shoot images.
- Do not charge battery packs except battery packs specified for this product. Doing so can result in leaks, overheating, explosions, electric shocks, burns, or injuries.
- If the charge lamp flashes when the battery pack is not fully charged, remove the battery pack or disconnect the USB cable from the camera and then reinsert it to recharge.
- We recommend charging the battery pack in an ambient temperature of between 10 °C and 30 °C (50 °F and 86 °F). The battery pack may not be effectively charged in temperatures outside this range.
- When you connect this product and a laptop computer that is not connected to a power source, the laptop's battery charge may decrease. Do not charge this product using the laptop computer for too long.
- Do not turn on/restart a computer, wake a computer from sleep mode, or turn off a computer while this product is connected to the computer via USB cable. Doing so may cause a malfunction of this product. Disconnect the product and the computer before performing the above operations.
- We do not guarantee charging if you are using a self-built or modified computer.
- When charging is finished, disconnect the AC Adaptor from the wall outlet (wall socket) or disconnect the USB cable from the camera. Not doing so may result in a shorter battery life.

Remaining battery indicator

- The remaining battery indicator appears on the screen.



A: Battery level high
B: Battery exhausted

- It takes about one minute for the correct remaining battery indicator to appear.
- The correct remaining battery indicator may not be displayed under some operating or environmental conditions.
- If the remaining battery indicator does not appear on the screen, press the DISP (Display Setting) button to display it.

Charging time (Full charge)

The charging time is approximately 150 minutes using the AC adaptor (supplied).

The above charging time applies when charging a fully depleted battery pack at a temperature of 25 °C (77 °F). Charging may take longer depending on conditions of use and circumstances.

Effective use of the battery pack

- Battery performance decreases in low temperature environments. So in cold places, the operational time of the battery pack is shorter. To ensure longer battery pack use, we recommend putting the battery pack in your pocket close to your body to warm it up, and insert it in the product immediately before you start shooting. If there are any metal objects such as keys in your pocket, be careful of causing a short-circuit.
- The battery pack will run down quickly if you use the flash or continuous shooting function frequently, turn the power on/off frequently, or set the monitor very bright.
- We recommend preparing spare battery packs and taking trial shots before taking the actual shots.
- If the battery terminal is dirty, you may not be able to turn on the product or the battery pack may not be properly charged. In that case, clean the battery by lightly wiping off any dust using a soft cloth or a cotton swab.

How to store the battery pack

To maintain the battery pack's function, charge the battery pack and then fully discharge it in the camera at least once a year before storing it. Store the battery in a cool, dry place after removing it from the camera.

On battery life

- The battery life is limited. If you use the same battery repeatedly, or use the same battery for a long period, the battery capacity decreases gradually. If the available time of the battery is shortened significantly, it is probably time to replace the battery pack with a new one.
- The battery life varies according to how the battery pack is stored and the operating conditions and environment in which each battery pack is used.

Notes on charging the battery pack

- The supplied AC Adaptor is dedicated to this product. Do not connect with other electronic devices. Doing so may cause a malfunction.
- Make sure to use a genuine Sony AC Adaptor.
- If the product's charge lamp flashes while charging, remove the battery pack being charged, and then insert the same battery pack firmly back into the product. If the charge lamp flashes again, this may indicate a faulty battery or that a battery pack other than the specified type has been inserted. Check that the battery pack is the specified type. If the battery pack is the specified type, remove the battery pack, replace it with a new or different one and check that the newly inserted battery is charging correctly. If the newly inserted battery is charging correctly, the previously inserted battery may be faulty.
- If the charge lamp flashes even if the AC Adaptor is connected to the product and the wall outlet (wall socket), this indicates that charging has stopped temporarily and is on standby. Charging stops and enters standby status automatically when the temperature is outside of the recommended operating temperature. When the temperature returns to the appropriate range, charging resumes and the charge lamp lights up again. We recommend charging the battery pack in an ambient temperature of between 10°C to 30°C (50°F to 86°F).

Interchangeable Lens Digital Camera
ILCE-6100 α6100

Inserting/removing a memory card

Explains how to insert a memory card (sold separately) to the product.

1 Open the battery/memory card cover.

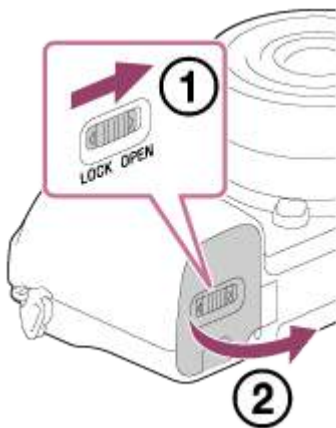

2 Insert the memory card.

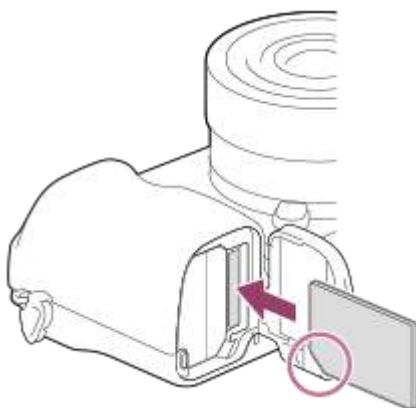

- With the notched corner facing in the direction illustrated, insert the memory card until it clicks into place. Insert the memory card correctly. Not doing so may cause a malfunction.

3 Close the cover.

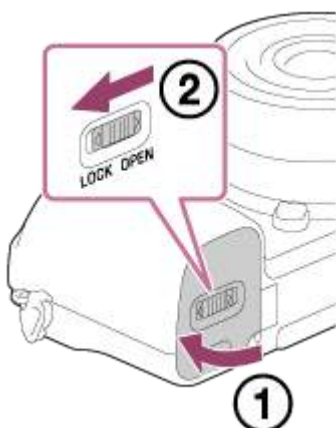

Hint

- When you use a memory card with the camera for the first time, it is recommended that you format the card on the camera for more stable performance of the memory card.

To remove the memory card

Open the memory card cover and make sure that the access lamp **(A)** is not lit, then push in the memory card lightly once to remove it.

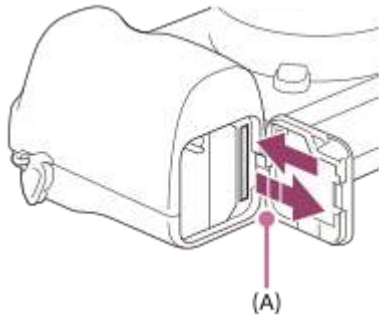

Related Topic

- [Memory cards that can be used](#)
- [Notes on memory card](#)
- [Format](#)

Interchangeable Lens Digital Camera
ILCE-6100 α6100

Memory cards that can be used

When using microSD memory cards or Memory Stick Micro media with this camera, be sure to use the appropriate adaptor.

SD memory cards

Recording format		Supported memory card
Still image		SD/SDHC/SDXC card
AVCHD		SD/SDHC/SDXC card (Class 4 or faster, or U1 or faster)
XAVC S	4K 60Mbps* HD 50Mbps or lower* HD 60Mbps	SDHC/SDXC card (Class 10, or U1 or faster)
	4K 100Mbps* HD 100Mbps	SDHC/SDXC card (U3)

* Including when recording proxy movies at the same time

Memory Stick media

Recording format		Supported memory card
Still image		Memory Stick PRO Duo/ Memory Stick PRO-HG Duo
AVCHD		Memory Stick PRO Duo (Mark 2)/ Memory Stick PRO-HG Duo
XAVC S	4K 60Mbps* HD 50Mbps or lower* HD 60Mbps	Memory Stick PRO-HG Duo
	4K 100Mbps* HD 100Mbps	—

* Including when recording proxy movies at the same time

Note

- When an SDHC memory card is used to record an XAVC S movie over extended periods of time, the recorded movies will be divided into files 4 GB in size. The divided files can be handled as a single file by importing them to a computer using PlayMemories Home.
- Fully charge the battery pack before attempting to recover the database files on the memory card.

Related Topic

- [Notes on memory card](#)
- [Number of recordable images](#)
- [Recordable movie times](#)

Notes on memory card

- If you repeatedly shoot and delete images for a long time, fragmentation of data in a file in the memory card may occur, and movie recording may be interrupted in the middle of shooting. If this happens, save your images to a computer or other storage location, then execute [Format] using this camera.
- Do not remove the battery pack or the memory card, disconnect the USB cable, or turn the camera off while the access lamp is lit up. This may cause the data on the memory card to become damaged.
- Be sure to back up the data for protection.
- Not all memory cards are guaranteed to operate correctly.
- Images recorded on an SDXC memory card cannot be imported to or played on computers or AV devices that are not compatible with exFAT when connected using a USB cable. Make sure that the device is compatible with exFAT before connecting it to the camera. If you connect your camera to an incompatible device, you may be prompted to format the card. Never format the card in response to this prompt, as doing so will erase all data on the card. (exFAT is the file system used on SDXC memory cards.)
- Do not expose the memory card to water.
- Do not strike, bend or drop the memory card.
- Do not use or store the memory card under the following conditions:
 - High temperature locations such as in a car parked under the sun
 - Locations exposed to direct sunlight
 - Humid locations or locations with corrosive substances present
- If the memory card is used near areas with strong magnetization, or used in locations subject to static electricity or electrical noise, the data on the memory card may become damaged.
- Do not touch the terminal section of the memory card with your hand or a metal object.
- Do not leave the memory card within the reach of small children. They might accidentally swallow it.
- Do not disassemble or modify the memory card.
- The memory card may be hot just after it has been used for a long time. Be careful when you handle it.
- Memory card formatted with a computer is not guaranteed to operate with the product. Format the memory card using this product.
- Data read/write speeds differ depending on the combination of the memory card and the equipment used.
- Do not press down hard when writing in the memo space on the memory card.
- Do not attach a label on the memory card itself nor on a memory card adaptor.
- If the write-protect switch or delete-protect switch of a memory card is set to the LOCK position, you cannot record or delete images. In this case, set the switch to the record position.
- To use a Memory Stick Micro media or microSD memory card with this product:
 - Be sure to insert the memory card into a dedicated adaptor. If you insert a memory card into the product without a memory card adaptor, you might not be able to remove it from the product.
 - When inserting a memory card into a memory card adaptor, be sure that the memory card is inserted in the correct direction and then insert it as far as it will go. If the card is not inserted properly, it may result in a malfunction.
- About Memory Stick PRO Duo media and Memory Stick PRO-HG Duo media:
 - This Memory Stick is equipped with MagicGate function. MagicGate is copyright protection technology that uses encryption technology.
Data recording/playback that requires MagicGate functions cannot be performed with this product.
 - High-speed data transfer using a parallel interface is supported.



Interchangeable Lens Digital Camera
ILCE-6100 α6100

Attaching/removing a lens

Turn off the camera before attaching or removing the lens.

- 1 Remove the body cap (A) from the camera and the rear lens cap (B) from the rear of the lens.

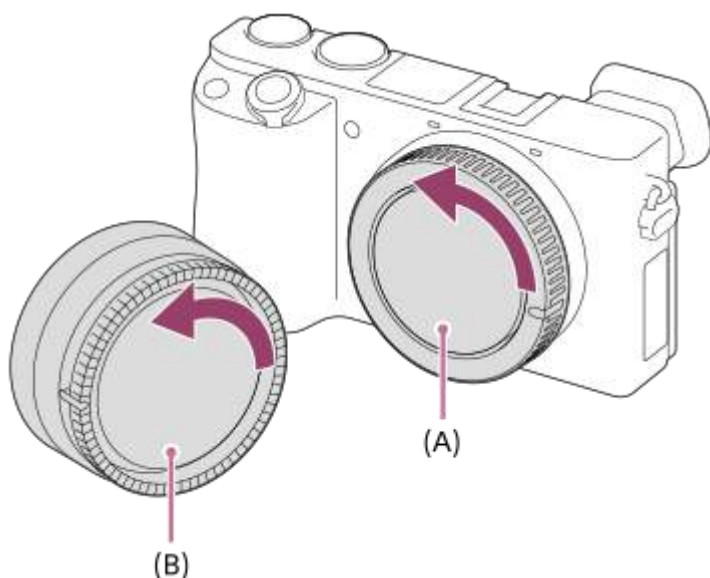

- It is recommended that you attach the front lens cap when you have done shooting.

- 2 Mount the lens by aligning the two white index marks (mounting indexes) on the lens and camera.

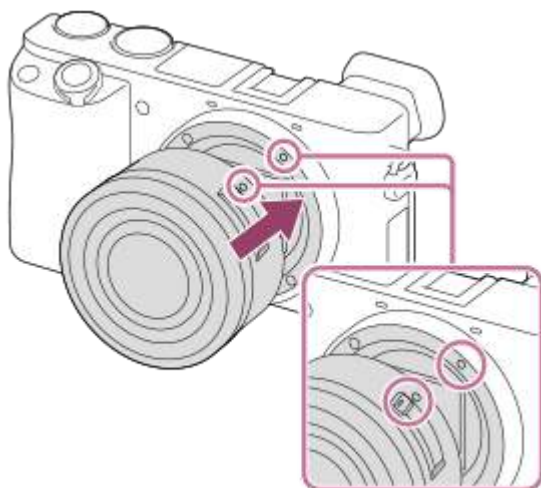

- Hold the camera with the lens mount facing down to prevent dust and debris from entering the camera.

- 3 While pushing the lens lightly toward the camera, turn the lens slowly in the direction of the arrow until it clicks into the locked position.



- Be sure to hold the lens straight when attaching it.

To remove the lens

Keep pressing the lens release button **(A)** and turn the lens in the direction of the arrow until it stops.

After removing the lens, attach the body cap to the camera and the lens caps to the front and rear of the lens to prevent dust and debris from entering the camera and lens.

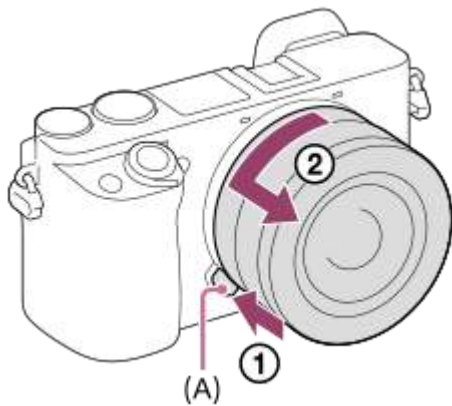

Note

- When attaching/removing the lens, work quickly in a dust-free location.
- Do not press the lens release button when attaching a lens.
- Do not use force when attaching a lens.
- A Mount Adaptor (sold separately) is required to use an A-mount lens (sold separately). When using the Mount Adaptor, refer to the operating manual supplied with the Mount Adaptor.
- When you use a lens with a tripod socket, attach a tripod to the tripod socket of the lens to help balance the weight of the lens.
- When carrying the camera with a lens attached, hold both the camera and the lens firmly.
- Do not hold the part of the lens that is extended for zoom or focus adjustment.

Related Topic

- [Attaching the lens hood](#)

Attaching the lens hood

We recommend that you use the lens hood to prevent light outside the shooting frame from affecting the image.

- 1 Match the shape of the lens hood mounting part and lens head, and turn the lens hood clockwise until it clicks.

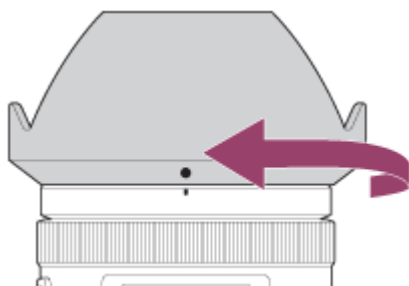

Note

- Attach the lens hood properly. Otherwise, the lens hood may not have any effect or may be partially reflected in the image.
- When the lens hood is attached properly, the lens hood index (red line) matches the red index mark on the hood. (There may be no lens hood index on some lenses.)
- Remove the lens hood when using the flash as the lens hood blocks the flash light and may appear as a shadow on the image.
- To store the lens hood after shooting, attach the lens hood to the lens backward.

Related Topic

- [Attaching/removing a lens](#)

Interchangeable Lens Digital Camera
ILCE-6100 α6100

Mount Adaptor

Using a Mount Adaptor (sold separately), you can attach an A-mount lens (sold separately) to this product. For details, refer to the operating instructions supplied with the Mount Adaptor.

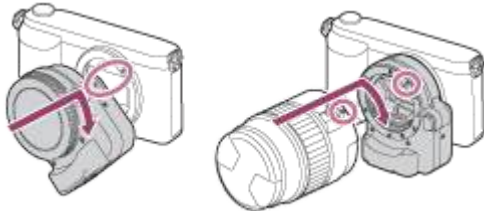

Note

- When a setting other than [Continuous Shooting: Lo] is selected for [Cont. Shooting], the focus is locked during the first shot, even if [Focus Mode] is set to [Continuous AF].
- You may not be able to use the Mount Adaptor or auto-focus with certain lenses. Consult your Sony dealer or local authorized Sony service facility on compatible lenses.
- You cannot use the AF illuminator when using an A-mount lens.
- The sound of the lens and the product in operation may be recorded during movie recording. You can turn the sound off by selecting MENU →  2 (Camera Settings2) → [Audio Recording] → [Off].
- It may take a long time or may be difficult for the product to focus, depending on the lens used or the subject.
- The light of the flash may be blocked by the lens attached.

Related Topic

- [LA-EA1/LA-EA3 Mount Adaptor](#)
- [LA-EA2/LA-EA4 Mount Adaptor](#)

Interchangeable Lens Digital Camera
ILCE-6100 α6100

LA-EA1/LA-EA3 Mount Adaptor

If you use the LA-EA1 Mount Adaptor (sold separately) or LA-EA3 Mount Adaptor (sold separately), the following functions are available.

Autofocus:

Available with SAM/SSM lens only

AF system:

Phase Detection AF

AF/MF select:

Can be changed using the operating switch on the lens.

Focus Mode:

Single-shot AF/Continuous AF

- When using a Mount Adaptor in the movie mode, adjust the aperture value and the focus manually.

Available focus area:

[Wide]/[Zone]/[Center]/[Flexible Spot]/[Expand Flexible Spot]/[Tracking]

Related Topic

- [Focus Area](#)

Interchangeable Lens Digital Camera
ILCE-6100 α6100

LA-EA2/LA-EA4 Mount Adaptor

If you use the LA-EA2 Mount Adaptor (sold separately) or LA-EA4 Mount Adaptor (sold separately), the following functions are available.

Autofocus:

Available

AF system:

Phase Detection AF, which is controlled by the dedicated AF sensor inside the Mount Adaptor

AF/MF select:

Lenses that do not support DMF (with a focus mode switch): Can be changed using the focus mode switch on the lens.

Lenses that support DMF (with a focus mode switch): Can be changed using the focus mode switch on the lens. When the focus mode switch on the lens is set to AF, you can change the focusing method by operating the camera.

Other lenses (without a focus mode switch): Can be changed by operating the camera.

Focus Mode:

LA-EA2: Single-shot AF/Continuous AF/DMF*

LA-EA4: Single-shot AF/Continuous AF/Automatic AF/DMF*

* Only available when using lenses that support Direct Manual Focus.

Available focus area:

Wide/Center/Flexible Spot/Tracking

Related Topic

- [Focus Area](#)

Interchangeable Lens Digital Camera
ILCE-6100 α6100

Setting language, date and time

The setting screen for language, date and time is displayed automatically when you turn on this product for the first time, initialize this product or when the internal rechargeable backup battery has discharged.

- 1 Turn on the camera.**

The language setting screen will appear and then setting screen for date and time will appear.
- 2 Select your language, and then press the center of the control wheel.**
- 3 Check that [Enter] is selected on the screen, then press the center.**
- 4 Select your desired geographic location, and then press the center.**
- 5 Select a setting item using the top/bottom side of the control wheel or by turning the control wheel, then press the center.**
- 6 Set [Daylight Savings], [Date/Time], and [Date Format] using the top/bottom/left/right sides, then press the center.**
 - Midnight is indicated as 12:00 AM, and noon as 12:00 PM when you set [Date/Time].
 - Change the values using the top/bottom when you set [Date/Time].
- 7 Repeat Steps 5 and 6 to set other items, then select [Enter] and press the center.**

On maintaining the date and time

This camera has an internal rechargeable battery for maintaining the date and time and other settings regardless of whether the power is on or off, or whether the battery pack is charged or discharged.

To charge the internal rechargeable backup battery, insert a charged battery pack into the camera, and leave the product for 24 hours or more with the power off.

If the clock resets every time the battery pack is charged, the internal rechargeable backup battery may be worn out. Consult your service facility.

Hint

- To set the date and time or geographic location again after the date and time setting is finished, select MENU →  (Setup) → [Date/Time Setup] or [Area Setting].

Note

- If the date and time setting is canceled halfway, the setting screen for the date and time appears every time you turn on the camera.
- This camera does not have a function for inserting the date on images. You can insert the date on images and then save and print them using PlayMemories Home (for Windows only).

Related Topic

- [Date/Time Setup](#)
- [Area Setting](#)
- [Using the control wheel](#)

5-009-879-12(1) Copyright 2019 Sony Corporation

Interchangeable Lens Digital Camera
ILCE-6100 α6100

In-Camera Guide

The [In-Camera Guide] displays descriptions of MENU items, Fn (Function) items, and settings.

- 1 Select the MENU or Fn item for which you want to see a description, and then press the  (Delete) button (A).



The descriptions of the item are displayed.

Shooting still images

- 1 Select the desired shooting mode by turning the mode dial.

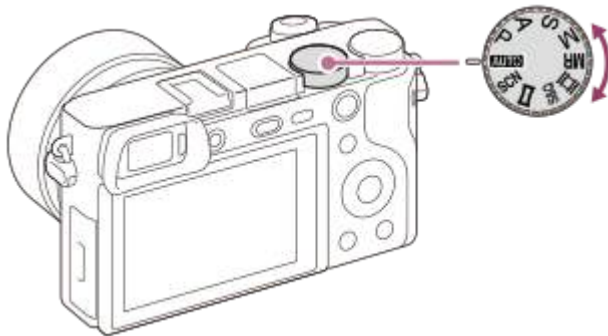

- 2 Adjust the monitor angle, and hold the camera. Or look through the viewfinder and hold the camera.

- 3 When a zoom lens is mounted, enlarge images by rotating the zoom ring.

- 4 Press the shutter button halfway down to focus.

When the image is in focus, a beep sounds and the indicator (such as ●) lights up.



- 5 Press the shutter button fully down.

To shoot images with the focus locked on the desired subject (Focus-lock)

Shoots images with the focus locked on the desired subject in auto focus mode.

1. MENU → 1 (Camera Settings1) → [Focus Mode] → [Single-shot AF] or [Automatic AF].
2. Place the subject within the AF area and press the shutter button halfway down.



The focus is locked.

- If it is difficult to focus on the desired subject, set [Focus Area] to [Center] or [Flexible Spot].

3. Keep pressing the shutter button halfway down, and place the subject back in the original position to re-compose the shot.



4. Press the shutter button down fully to take the picture.

Hint

- When the product cannot focus automatically, the focus indicator flashes and the beep does not sound. Either re-compose the shot or change the focus setting. In [Continuous AF] mode,  lights up and the beep indicating that the focus has been achieved does not sound.
- An icon indicating that data is being written is displayed after shooting. Do not remove the memory card while the icon is displayed.

Note

- When the subject is moving, you cannot lock the focus even if [Focus Mode] has been set to [Automatic AF].

Related Topic

- [List of mode dial function](#)
- [Clear Image Zoom/Digital Zoom \(Zoom\)](#)
- [Playing back still images](#)
- [Auto Review](#)
- [Focus Mode](#)
- [Focus Area](#)

Interchangeable Lens Digital Camera
ILCE-6100 α6100

Focus Mode

Selects the focus method to suit the movement of the subject.

1 MENU →  1 (Camera Settings1) → [Focus Mode] → desired setting.

Menu item details

AF-S (Single-shot AF):

The product locks the focus once focusing is complete. Use this when the subject is motionless.

AF-A (Automatic AF):

[Single-shot AF] and [Continuous AF] are switched according to the movement of the subject. When the shutter button is pressed halfway down, the product locks the focus when it determines that the subject is motionless, or continues to focus when the subject is in motion. During continuous shooting, the product automatically shoots with Continuous AF from the second shot.

AF-C (Continuous AF):

The product continues to focus while the shutter button is pressed and held halfway down. Use this when the subject is in motion. In [Continuous AF] mode, there is no beep when the camera focuses.

DMF (DMF):

You can make fine adjustments manually after performing auto focusing, letting you focus on a subject more quickly than when using the manual focus from the beginning. This is convenient in situations such as macro shooting.

MF (Manual Focus):

Adjusts the focus manually. If you cannot focus on the intended subject using auto focus, use manual focus.

Focus indicator

● (lit):

The subject is in focus and the focus is locked.

● (flashing):

The subject is not in focus.

⊕ (lit):

The subject is in focus. The focus will be adjusted continuously according to the movements of the subject.

⊕ (lit):

Focusing is in progress.

Subjects on which it is difficult to focus using auto focus

- Dark and distant subjects
- Subjects with poor contrast
- Subjects seen through glass
- Fast-moving subjects
- Reflective light or shiny surfaces
- Flashing light
- Back-lit subjects
- Continuously repetitive patterns, such as the facades of buildings
- Subjects in the focusing area with different focal distances

Hint

- In [Continuous AF] mode, you can lock the focus by pressing and holding the button that has been assigned the [Focus Hold] function.

- When you set the focus to infinity in the manual focus mode or the direct manual focus mode, make sure that the focus is on a sufficiently distant subject by checking the monitor or the viewfinder.

Note

- [Automatic AF] is available only when you are using a lens that supports phase detection AF.
- When [Continuous AF] or [Automatic AF] is set, the angle of view may change little by little while focusing. This does not affect the actual recorded images.
- Only [Continuous AF] and [Manual Focus] are available when shooting movies or when the mode dial is set to **S&Q**.

Related Topic

- [Direct manual focus \(DMF\)](#)
- [Manual Focus](#)
- [MF Assist \(still image\)](#)
- [Phase detection AF](#)

Interchangeable Lens Digital Camera
ILCE-6100 α6100

Focus Area

Selects the focusing area. Use this function when it is difficult to focus properly in the auto focus mode.

① MENU →  1 (Camera Settings1) → [Focus Area] → desired setting.

Menu item details

Wide :

Focuses on a subject covering the whole range of the screen automatically. When you press the shutter button halfway down in the still image shooting mode, a green frame is displayed around the area that is in focus.

Zone :

Select a zone on the monitor on which to focus, and the product will automatically select a focus area.

Center :

Focuses automatically on a subject in the center of the image. Use together with the focus-lock function to create the composition you want.

Flexible Spot :

Allows you to move the focusing frame to a desired point on the screen and focus on an extremely small subject in a narrow area.

Expand Flexible Spot :

If the product cannot focus on a single selected point, it uses focus points around the flexible spot as a secondary priority area for focusing.

Tracking:

When the shutter button is pressed and held halfway down, the product tracks the subject within the selected autofocus area. This setting is available only when the focus mode is set to [Continuous AF]. Point the cursor at [Tracking] on the [Focus Area] setting screen, and then select the desired area to start tracking using the left/right sides of the control wheel. You can also move the tracking start area to the desired point by designating the area as a zone, flexible spot or expand flexible spot.

Examples of the focusing frame display

The focusing frame differs as follows.

When focusing on a larger area

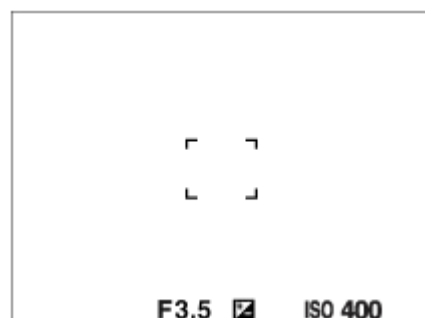

When focusing on a smaller area

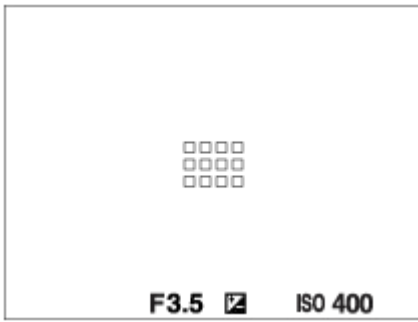

- When [Focus Area] is set to [Wide] or [Zone], the focusing frame may switch between “When focusing on a larger area” and “When focusing on a smaller area” depending on the subject or situation.
- When you attach an A-mount lens with a Mount Adaptor (LA-EA1 or LA-EA3) (sold separately), the focusing frame for “When focusing on a smaller area” may be displayed.

When focus is achieved automatically based on the whole range of the monitor

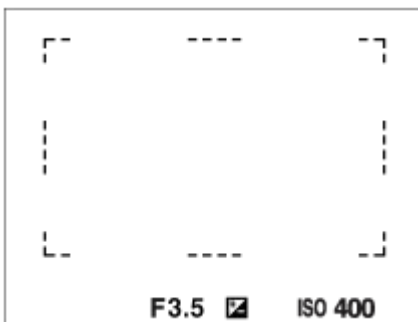

- When you use a zoom function other than the optical zoom, the [Focus Area] setting is disabled and the focusing frame is shown by the dotted line. The AF operates with priority on and around the center area.

To move the focus area

- When [Focus Area] is set to [Zone], [Flexible Spot] or [Expand Flexible Spot], if pressing the button to which [Focus Standard] is assigned, you can shoot while moving the focusing frame using the top/bottom/left/right sides of the control wheel. To return the focusing frame to the center of the monitor, press the  button while moving the frame. To change the shooting settings using the control wheel, press the button to which [Focus Standard] is assigned.
- You can move the focusing frame quickly by touching and dragging it on the monitor. Set [Touch Operation] to [On], and set [Func. of Touch Operation] to [Touch Focus] beforehand.

Note

- [Focus Area] is locked to [Wide] in the following situations:
 - [Intelligent Auto]
 - [Superior Auto]
 - [Scene Selection]
 - During Smile Shutter mode
- The focus area may not light up during continuous shooting or when the shutter button is pressed all the way down at once.
- When the mode dial is set to  (Movie) or **S&Q** or during movie shooting, [Tracking] cannot be selected as the [Focus Area].
- When [Subject Detection] for [Face/Eye AF Set.] is set to [Animal], [Tracking] cannot be selected as the [Focus Area].
- You cannot perform functions assigned to the up/down/left/right sides of the control wheel or the custom button 2 while moving the focusing frame.



Related Topic

Interchangeable Lens Digital Camera
ILCE-6100 α6100

Phase detection AF

When there are phase detection AF points within the auto focus area, the product uses the combined autofocus of the phase detection AF and contrast AF.

Note



- Phase detection AF is available only when an applicable lens is attached. If you use a lens that does not support phase detection AF, you cannot use [Automatic AF], [ AF Tracking Sens.] or [ AF drive speed]. Also, even if you use a previously purchased applicable lens, the phase detection AF might not function unless you update the lens. For details on compatible lenses, visit the Sony web site in your area, or consult your Sony dealer or local authorized Sony service facility.

Interchangeable Lens Digital Camera
ILCE-6100 α6100

Focus Standard

If you assign [Focus Standard] to the desired custom key, you can recall useful functions such as moving the focusing frame quickly, etc., depending on the focus area settings.

1 MENU →  (Camera Settings2) → [ Custom Key] → desired key, then assign the [Focus Standard] function to the key.

- To use the [Focus Standard] function while shooting movies, select MENU →  (Camera Settings2) → [ Custom Key] → the desired button, and then assign [Focus Standard] to the key.

2 Press the key to which [Focus Standard] is assigned.

- What you can do by pressing the key varies depending on the setting for [Focus Area].

When [Focus Area] is set to [Zone], [Flexible Spot], [Expand Flexible Spot], [Tracking: Zone], [Tracking: Flexible Spot] or [Tracking: Expand Flexible Spot]:

Pressing the key moves the position of the focusing frame using the top/bottom/left/right sides of the control wheel.

When [Focus Area] is set to [Wide], [Center], [Tracking: Wide] or [Tracking: Center]:

The camera focuses on the center of the screen when you press the key.

Note

- You cannot set the [Focus Standard] function to [Left Button], [Right Button] or [Down Button].

Related Topic

- [Assigning frequently used functions to buttons \(Custom Key\)](#)
- [Focus Area](#)

Interchangeable Lens Digital Camera
ILCE-6100 α6100

AF/MF control

You can easily switch the focusing mode from auto to manual and vice versa while shooting without changing your holding position.

- 1 MENU →  2 (Camera Settings2) → [ Custom Key] or [ Custom Key] → desired button → [AF/MF Control Hold] or [AF/MF Ctrl Toggle].

Menu item details

AF/MF Control Hold :

Switches the focusing mode while the button is held down.

AF/MF Ctrl Toggle :

Switches the focusing mode until the button is pressed again.

Note

- You cannot set the [AF/MF Control Hold] function to [Left Button], [Right Button] or [Down Button] of the control wheel.



Related Topic

- [Assigning frequently used functions to buttons \(Custom Key\)](#)

Interchangeable Lens Digital Camera
ILCE-6100 α6100

AF w/ shutter (still image)

Selects whether to focus automatically when you press the shutter button halfway down. Select [Off] to adjust the focus and the exposure separately.

1 MENU →  1 (Camera Settings1) → [ AF w/ shutter] → desired setting.

Menu item details

On:





The auto focus operates when you press the shutter button halfway down.

Off:

The auto focus does not operate even if you press the shutter button halfway down.

Useful method to micro-adjust the focus

When an A-mount lens is attached, activating the auto focus function with a button other than the shutter button lets you focus more precisely in combination with manual focusing.

1. Set [ AF w/ shutter] to [Off].
2. MENU →  2 (Camera Settings2) → [ Custom Key] or [ Custom Key] → assign the [AF On] and [Focus Magnifier] functions to the desired keys.
3. Set [ Eye-Start AF] to [Off] to avoid auto focusing when you look through the viewfinder.
4. Press the key to which the [AF On] function is assigned.
5. Press the key to which the [Focus Magnifier] function is assigned, and then rotate the focus ring for micro-adjustments of the focus.
6. Press the shutter button fully down to shoot the image.



Related Topic

- [AF On](#)
- [Eye-Start AF \(still image\)](#)
- [Pre-AF \(still image\)](#)
- [Focus Magnifier](#)





Interchangeable Lens Digital Camera
ILCE-6100 α6100

AF On

You can focus without pressing the shutter button halfway down. The settings for [Focus Mode] will be applied.

- 1 MENU →  2 (Camera Settings2) → [ Custom Key] or [ Custom Key] → desired key, then assign the [AF On] function to the key.
- 2 Press the key to which you have assigned the [AF On] function while auto-focus shooting.

Hint

- Set [ AF w/ shutter] to [Off] when you do not want to perform auto focusing using the shutter button.
- Set [ AF w/ shutter], [ Pre-AF], and [ Eye-Start AF] to [Off] to focus at a specific shooting distance predicting the position of the subject.

Related Topic

- [Assigning frequently used functions to buttons \(Custom Key\)](#)
- [AF w/ shutter \(still image\)](#)
- [Pre-AF \(still image\)](#)
- [Eye-Start AF \(still image\)](#)

Interchangeable Lens Digital Camera
ILCE-6100 α6100

Face/Eye AF Set.

This function is used to determine whether or not the camera will focus with priority on faces or eyes.

There are two ways to perform [Eye AF].

- Focusing on the eyes by pressing the shutter button halfway down.
- Focusing on the eyes by pressing the custom key. For details on using the custom key to perform [Eye AF], refer to the explanation below (▼).

① MENU →  1 (Camera Settings1) → [Face/Eye AF Set.] → desired setting item.

Menu item details

Face/Eye Priority in AF :

Sets whether or not to detect faces or eyes inside the focusing area and focus on the eyes (Eye AF) when autofocus is activated. ([On]/[Off])

(Note: The camera operations are different when using the custom key to execute [Eye AF].)

Subject Detection :

Selects the target to be detected.

[Human]: Detects human faces/eyes.

[Animal]: Detects animal eyes. Animal faces are not detected.

Right/Left Eye Select :

Specifies the eye to be detected when [Subject Detection] is set to [Human]. If [Right Eye] or [Left Eye] is selected, only the selected eye is detected. When [Subject Detection] is set to [Animal], [Right/Left Eye Select] cannot be used.

[Auto]: The camera detects eyes automatically.

[Right Eye]: The right eye of the subject (the eye on the left side from the photographer's perspective) is detected.

[Left Eye]: The left eye of the subject (the eye on the right side from the photographer's perspective) is detected.

Face Detect. Frame Disp. :

Sets whether or not to display the face detection frame when a human face is detected. ([On]/[Off])

Animal Eye Display :

Sets whether or not to display the eye detection frame when the eye of an animal is detected. ([On]/[Off])

Face detection frame

When the product detects a face, the gray face detection frame appears. When the product determines that autofocus is enabled, the face detection frame turns white.

In case you have registered the priority order for each face using [Face Registration], the product automatically selects the first prioritized face and the face detection frame over that face turns white. The face detection frames of other registered faces turn reddish-purple.



Eye detection frame

A white eye detection frame appears when an eye is detected and the camera determines that autofocusing is possible, depending on the settings.

The eye detection frame is displayed as follows when [Subject Detection] is set to [Animal].



[Eye AF] by custom key

The Eye AF function can also be used by assigning [Eye AF] to a custom key. The camera can focus on eyes as long as you are pressing the key. This is useful when you want to temporarily apply the Eye AF function to the entire screen regardless of the setting for [Focus Area]. The camera does not focus automatically if no faces or eyes are detected. (Note: When you try to focus on eyes by pressing the shutter button halfway down, the camera only detects faces or eyes inside the focus area designated with [Focus Area]. If the camera detects no faces or eyes, it performs normal auto-focusing.)

1. MENU → (Camera Settings2) → [Custom Key] → desired key, then assign the [Eye AF] function to the key.
2. MENU → (Camera Settings1) → [Face/Eye AF Set.] → [Subject Detection] → desired setting.
3. Point the camera at the face of a human or animal, and press the key to which you have assigned the [Eye AF] function.
4. Press the shutter button while pressing the key.

[Switch Right/Left Eye] by custom key

When [Right/Left Eye Select] is set to [Right Eye] or [Left Eye], you can switch the eye to be detected by pressing the custom key to which you have assigned the [Switch Right/Left Eye] function.

When [Right/Left Eye Select] is set to [Auto], you can temporarily switch the eye to be detected by pressing the custom key to which you have assigned the [Switch Right/Left Eye] function.



The temporary left/right selection is cancelled when you perform the following operations, etc. The camera returns to automatic eye detection.

- Stopping pressing the shutter button halfway down
- Stopping pressing the custom key to which [AF On] or [Eye AF] is assigned
- Pressing the Fn button or MENU button

Hint

- When [Right/Left Eye Select] is not set to [Auto], or you execute [Switch Right/Left Eye] using the custom key, the eye detection frame appears.
- If you want the face or eye detection frame to disappear within a certain period of time after the camera has focused on the face or eye, set [AF Area Auto Clear] to [On].
- To detect animal eyes, arrange the composition so that both eyes and the nose of the animal are within the angle of view. Once you focus on the animal's face, the animal's eyes will be detected more easily.

Note

- When [Subject Detection] is set to [Human], the eyes of animals are not detected. When [Subject Detection] is set to [Animal], human faces are not detected.
- When [Scene Selection] is set to [Portrait], [Face/Eye Priority in AF] is locked to [On], and [Subject Detection] is locked to [Human].
- When [Smile Shutter] is set to [On], [Face/Eye Priority in AF] is locked to [On], and [Subject Detection] is locked to [Human].
- When [Subject Detection] is set to [Animal], the following functions cannot be used.
 - Tracking function
 - Face Priority in Multi Metering
 - Regist. Faces Priority
 -  Soft Skin Effect
- The [Eye AF] function may not function very well in the following situations:
 - When the person is wearing sunglasses.
 - When the front hair covers the person's eyes.
 - In low-light or back-lit conditions.
 - When the eyes are closed.
 - When the subject is in the shade.
 - When the subject is out of focus.
 - When the subject is moving too much.
- If the subject is moving too much, the detection frame may not be displayed correctly over their eyes.
- Depending on the circumstances, the eyes cannot be focused.
- When the camera cannot focus on human eyes, it will detect and focus on the face instead. The camera cannot focus on eyes when no human faces are detected.
- The product may not detect faces at all or may accidentally detect other objects as faces in some conditions.
- The Eye AF function is unavailable when the mode dial is set to  (Movie) or **S&Q**, or during movie shooting.
- The eye detection frame is not displayed when the Eye AF function is unavailable.
- You cannot use the face/eye detection function with the following functions:
 - Zoom functions other than the optical zoom.
 - [Sweep Panorama]
 - [Posterization] under [Picture Effect]
 - Focus Magnifier
 - When [Scene Selection] is set to [Landscape], [Night Scene], or [Sunset]
 - When [**S&Q** Frame Rate] is set to [120fps]/[100fps] during slow-motion/quick-motion shooting.
- You cannot use the face detection function with the following functions:
 - Movie shooting with  Record Setting] set to [120p]/[100p]
- Up to 8 faces of your subjects can be detected.
- Even if [Face Detect. Frame Disp.] or [Animal Eye Display] is set to [Off], a green focusing frame will be displayed over faces or eyes that are in focus.
- When the shooting mode is set to [Intelligent Auto] or [Superior Auto], [Face/Eye Priority in AF] is locked to [On].
- Even when [Subject Detection] is set to [Animal], the eyes of some types of animals cannot be detected.



Related Topic

- [Focus Mode](#)
- [Focus Area](#)
- [AF Area Auto Clear](#)
- [Assigning frequently used functions to buttons \(Custom Key\)](#)

Interchangeable Lens Digital Camera
ILCE-6100 α6100

AF in Focus Mag. (still image)





You can focus on the subject more accurately using auto-focus by magnifying the area where you want to focus. While the magnified image is displayed, you can focus on a smaller area than the flexible spot.

- 1 MENU →  1 (Camera Settings1) → [ AF in Focus Mag.] → [On].
- 2 MENU →  1 (Camera Settings1) → [Focus Magnifier].
- 3 **Magnify the image by pressing the center of the control wheel, and then adjust the position using top/bottom/right/left of the control wheel.**
 - The magnification scale changes each time you press the center.
- 4 **Press the shutter button halfway down to focus.**
 - The focus will be achieved at point of + in the center of the screen.
- 5 **Press the shutter button all the way down to shoot.**
 - The camera exits the magnified display after shooting.

Hint

- Use of a tripod is recommended to accurately identify the location you want to magnify.
- You can check the auto-focusing result by magnifying the displayed image. If you want to readjust the focus position, adjust the focus area on the magnified screen and then press the shutter button halfway down.

Note

- If you enlarge an area at the edge of the screen, the camera may not be able to focus.
- The exposure and white balance cannot be adjusted while the displayed image is being magnified.
- [ AF in Focus Mag.] is unavailable in the following situations:
 - In [Sweep Panorama] mode
 - During movie shooting
 - When [Focus Mode] is set to [Continuous AF].
 - When [Focus Mode] is set to [Automatic AF] and the shooting mode is set to other than P/A/S/M.
 - When [Focus Mode] is set to [Automatic AF] and [Drive Mode] is set to [Cont. Shooting].
 - When using a Mount Adaptor (sold separately).
- While the displayed image is being magnified, the following functions are unavailable:
 - [Eye AF]
 - [ Eye-Start AF]
 - [ Pre-AF]
 - [Face/Eye Priority in AF]
 - [ Auto Object Framing]

Related Topic

- [Focus Magnifier](#)

5-009-879-12(1) Copyright 2019 Sony Corporation

Interchangeable Lens Digital Camera
ILCE-6100 α6100

Tracking subject (Tracking function)

This camera has the function of tracking which tracks the subject, and keeps marking it with the focusing frame. You can set the start position to track by selecting from focusing areas, or by specifying by touch operation. The required function varies depending on the setting method.

- For the examples of usage, etc. of tracking function, refer to the following URL.
For still image shooting:
https://support.d-imaging.sony.co.jp/support/tutorial/ilc/l/ilce-6100/still_tracking.php
For movie shooting:
https://support.d-imaging.sony.co.jp/support/tutorial/ilc/l/ilce-6100/movie_tracking.php
- You can refer to the related functions under “Related Topic” at the bottom of this page.

Setting the start position to track by focusing area ([Tracking] under [Focus Area])

The selected focusing frame is set as the start position to track, and the tracking starts by pressing the shutter button halfway down.

- This function is available in still image shooting mode.
- This function is available when [Focus Mode] is set to [Continuous AF].

Setting the start position to track by touch operation ([Touch Tracking] under [Func. of Touch Operation])

You can set the subject to track by touching it on the monitor.

- This function is available in still image shooting mode and movie shooting mode.
- This function is available when [Focus Mode] is set to [Single-shot AF], [Automatic AF], [Continuous AF], or [DMF].



Related Topic

- [Focus Mode](#)
- [Focus Area](#)
- [Func. of Touch Operation: Touch Tracking](#)

Interchangeable Lens Digital Camera
ILCE-6100 α6100

Focus Hold

Locks the focus while the key to which the Focus Hold function has been assigned is pressed.

- 1 MENU →  2 (Camera Settings 2) → [ Custom Key] or [ Custom Key] → assign the [Focus Hold] function to the key of your choice.
 - 2 Focus and press the key to which the [Focus Hold] function has been assigned.
 - 3 Press the shutter button while holding down the key.
-

Related Topic

- [Assigning frequently used functions to buttons \(Custom Key\)](#)

Interchangeable Lens Digital Camera
ILCE-6100 α6100

Pre-AF (still image)

The product automatically adjusts focus before you press the shutter button halfway down. During focusing operations, the screen may shake.

① MENU →  1 (Camera Settings1) → [ Pre-AF] → desired setting.

Menu item details

On:

Adjusts focus before you press the shutter button halfway down.

Off:

Does not adjust focus before you press the shutter button halfway down.



Note

- [ Pre-AF] is available only when an E-mount lens is mounted.

Interchangeable Lens Digital Camera
ILCE-6100 α6100

Eye-Start AF (still image)

Sets whether or not to use autofocus when you look through an Electronic Viewfinder.

1 MENU →  1 (Camera Settings1) → [ Eye-Start AF] → desired setting.

Menu item details

On:

Auto focusing starts when you look through the Electronic Viewfinder.

Off:

Auto focusing does not start when you look through the Electronic Viewfinder.



Hint

- [ Eye-Start AF] is available when an A-mount lens and a Mount Adaptor (LA-EA2, LA-EA4) (sold separately) are attached.

Interchangeable Lens Digital Camera
ILCE-6100 α6100

AF Illuminator (still image)

The AF illuminator supplies fill light to focus more easily on a subject in dark surroundings. In the time between pressing the shutter button halfway down and locking the focus, the AF illuminator lights up to allow the camera to focus easily.

1 MENU →  1 (Camera Settings1) → [ AF Illuminator] → desired setting.

Menu item details



Auto:

The AF illuminator lights up automatically in dark surroundings.

Off:

Does not use the AF illuminator.

Note

- You cannot use [ AF Illuminator] in the following situations:
 - When the shooting mode is [Movie] or [S&Q Motion].
 - Sweep Panorama
 - When [Focus Mode] is set to [Continuous AF] or [Automatic AF] and the subject is moving (when the focus indicator  or  lights up).
 - When [Focus Magnifier] is activated.
 - When [Scene Selection] is set to the following modes:
 - [Landscape]
 - [Sports Action]
 - [Night Scene]
 - When a Mount Adaptor is attached.
- If the Multi Interface Shoe is equipped with a flash with an AF illuminator function, when the flash is turned on, the AF illuminator will turn on as well.
- The AF illuminator emits a very bright light. Although there is no health hazard, do not look directly into the AF illuminator at close range.

Interchangeable Lens Digital Camera
ILCE-6100 α6100

AF Area Auto Clear

Sets whether the focus area should be displayed all the time or should disappear automatically shortly after focus is achieved.

① **MENU** →  1 (Camera Settings1) → **[AF Area Auto Clear]** → **desired setting**.

Menu item details

On:

The focus area disappears automatically shortly after focus is achieved.

Off:

The focus area is displayed all the time.

Interchangeable Lens Digital Camera
ILCE-6100 α6100

Disp. cont. AF area

You can set whether or not to display the area that is in focus when [Focus Area] is set to [Wide] or [Zone], in [Continuous AF] mode.

① MENU →  1 (Camera Settings1) → [Disp. cont. AF area] → desired setting.

Menu item details

On:

Displays the focus area that is in focus.

Off:

Does not display the focus area that is in focus.

Note

- When [Focus Area] is set to one of the following, the focusing frames in the area that is in focus turn green:
 - [Center]
 - [Flexible Spot]
 - [Expand Flexible Spot]

Interchangeable Lens Digital Camera
ILCE-6100 α6100

AF Micro Adj.

Allows you to adjust the auto-focusing position and register an adjusted value for each lens when using A-mount lenses with an LA-EA2 or LA-EA4 Mount Adaptor (sold separately).

Use this function only when adjustments are needed. Note that the auto focus function may not be performed at a proper position when using this adjustment.

1 MENU →  (Camera Settings1) → [AF Micro Adj.].

2 Select [AF Adjustment Set.] → [On].

3 [amount] → desired value.

- The larger the value you select, the farther the autofocused position will be from the product. The smaller the value you select, the closer the autofocused position will be to the product.

Hint

- It is recommended that you adjust the position under actual shooting conditions. Set [Focus Area] to [Flexible Spot] and use a bright subject with high contrast when you adjust.

Note

- When you attach a lens for which you have already registered a value, the registered value appears on the screen. [±0] appears for lenses for which a value has not yet been registered.
- If [-] is displayed as the value, then a total of 30 lenses have been registered and no new lens can be registered. To register a new lens, attach a lens for which the registration can be erased, and set its value to [±0], or reset the values of all the lenses using [Clear].
- The [AF Micro Adj.] supports Sony, Minolta, or Konica-Minolta lenses. If you perform [AF Micro Adj.] with lenses other than the supported lenses, the registered settings for the supported lenses may be affected. Do not perform [AF Micro Adj.] with an unsupported lens.
- You cannot set [AF Micro Adj.] individually for a Sony, Minolta, and Konica-Minolta lens of the same specification.

Manual Focus

When it is difficult to focus properly in the autofocus mode, you can adjust the focus manually.

1 MENU →  1 (Camera Settings1) → [Focus Mode] → [Manual Focus].

2 Rotate the focusing ring to achieve sharp focus.



- When you rotate the focusing ring, the focus distance is displayed on the screen.
The focus distance is not displayed when the Mount Adaptor (sold separately) is attached.

3 Press the shutter button fully down to shoot an image.

Note

- When you use the viewfinder, adjust the diopter level to obtain the correct focus on the viewfinder.
- The displayed focus distance is just a reference.

Related Topic

- [Focus Magnifier](#)
- [Peaking Setting](#)
- [MF Assist \(still image\)](#)

Direct manual focus (DMF)

You can make fine adjustments manually after performing auto focusing, letting you focus on a subject more quickly than when using the manual focus from the beginning. This is convenient in situations such as macro shooting.

- 1 **MENU** →  (Camera Settings1) → **[Focus Mode]** → **[DMF]**.
- 2 **Press the shutter button halfway down to focus automatically.**
- 3 **Keep the shutter button pressed halfway down, and then rotate the focusing ring to achieve a sharper focus.**



- When you rotate the focusing ring, the focus distance is displayed on the screen.
The focus distance is not displayed when the Mount Adaptor (sold separately) is attached.

- 4 **Press the shutter button fully down to shoot an image.**

Related Topic









- [Peaking Setting](#)

Interchangeable Lens Digital Camera
ILCE-6100 α6100

Focus Magnifier

You can check the focus by enlarging the image before shooting.

Unlike with [ MF Assist], you can magnify the image without operating the focus ring.

- 1 **MENU** →  1 (Camera Settings1) → [**Focus Magnifier**].
- 2 **Press the center of the control wheel to enlarge the image and select the area you want to enlarge using top/bottom/left/right side of the control wheel.**
 - Each time you press the center, the magnification scale will change.
 - You can set the initial magnification by selecting MENU →  1 (Camera Settings1) → [ Initial Focus Mag.].
- 3 **Confirm the focus.**
 - Press the  (Delete) button to bring the magnified position into the center of an image.
 - When the focus mode is [Manual Focus], you can adjust the focus while an image is magnified. If [ AF in Focus Mag.] is set to [Off], the [Focus Magnifier] function is canceled when the shutter button is pressed halfway down.
 - When the shutter button is pressed halfway down while an image is magnified during the auto-focusing, different functions are performed depending on the [ AF in Focus Mag.] setting.
 - When [ AF in Focus Mag.] is set to [On]: Auto-focusing is performed again.
 - When [ AF in Focus Mag.] is set to [Off]: The [Focus Magnifier] function is canceled.
 - You can set how long the image is to be shown magnified by selecting MENU →  1 (Camera Settings1) → [Focus Magnif. Time].
- 4 **Press the shutter button fully down to shoot the image.**

To use the focus magnifier function by touch operation

You can magnify the image and adjust the focus by touching the monitor. Set [Touch Operation] to [On] beforehand.

Then, select the appropriate settings under [Touch Panel/Pad]. When the focus mode is [Manual Focus], you can perform [Focus Magnifier] by double-tapping the area to focus on while shooting with the monitor.

While shooting with the viewfinder, a frame is displayed in the center of the monitor by double-tapping and you can move the frame by dragging it. The image is magnified by pressing the center of the control wheel.

Hint

- While using the focus magnifier function, you can move the magnified area by dragging it on the touch panel.
- To exit the focus magnifier function, double-tap the monitor again. When [ AF in Focus Mag.] is set to [Off], the focus magnifier function is ended by pressing the shutter button halfway down.

Related Topic

- [MF Assist \(still image\)](#)

- Focus Magnif. Time
- Initial Focus Mag. (still image)
- AF in Focus Mag. (still image)
- Touch Operation

5-009-879-12(1) Copyright 2019 Sony Corporation

Interchangeable Lens Digital Camera
ILCE-6100 α6100

MF Assist (still image)

Enlarges the image on the screen automatically to make manual focusing easier. This works in Manual Focus or Direct Manual Focus shooting.

1 MENU →  1 (Camera Settings1) → [ MF Assist] → [On].



2 Turn the focus ring to adjust the focus.

- The image is enlarged. You can magnify images further by pressing the center of the control wheel.

Hint

- You can set how long the image is to be shown magnified by selecting MENU →  1 (Camera Settings1) → [Focus Magnif. Time].

Note

- You cannot use [ MF Assist] when shooting movies. Use the [Focus Magnifier] function instead.
- [ MF Assist] is not available when a Mount Adaptor is attached. Use the [Focus Magnifier] function instead.

Related Topic

- [Manual Focus](#)
- [Direct manual focus \(DMF\)](#)
- [Focus Magnif. Time](#)

Interchangeable Lens Digital Camera
ILCE-6100 α6100

Focus Magnif. Time

Set the duration for which an image is to be magnified using the [ MF Assist] or [Focus Magnifier] function.

1 MENU →  (Camera Settings1) → [Focus Magnif. Time] → desired setting.

Menu item details

2 Sec:

Magnifies the images for 2 seconds.

5 Sec:

Magnifies the images for 5 seconds.

No Limit:

Magnifies the images until you press the shutter button.



Related Topic

- [Focus Magnifier](#)
- [MF Assist \(still image\)](#)

Interchangeable Lens Digital Camera
ILCE-6100 α6100

Initial Focus Mag. (still image)

Sets the initial magnification scale when using [Focus Magnifier]. Select a setting that will help you frame your shot.

1 MENU →  1 (Camera Settings1) → [ Initial Focus Mag.] → **desired setting.**

Menu item details

x1.0:

Displays the image with the same magnification as the shooting screen.

x5.9:

Displays a 5.9-times enlarged image.

Related Topic

- [Focus Magnifier](#)

Interchangeable Lens Digital Camera
ILCE-6100 α6100

Peaking Setting

Sets the peaking function, which enhances the outline of in-focus areas during shooting with Manual Focus or Direct Manual Focus.

① MENU →  1 (Camera Settings1) → [Peaking Setting] → desired setting.

Menu item details

Peaking Display:

Sets whether to display peaking.

Peaking Level:

Sets the level of enhancement of in-focus areas.

Peaking Color:

Sets the color used to enhance in-focus areas.

Note

- Since the product recognizes sharp areas as in focus, the effect of peaking differs, depending on the subject and lens.
- The outline of in-focus ranges is not enhanced on devices connected via HDMI.



Related Topic

- [Manual Focus](#)
- [Direct manual focus \(DMF\)](#)

Interchangeable Lens Digital Camera
ILCE-6100 α6100

Drive Mode

Select the appropriate mode for the subject, such as single shooting, continuous shooting or bracketing shooting.

- 1 Select  /  (Drive Mode) on the control wheel → desired setting.
 - You can also set the drive mode by selecting MENU →  1 (Camera Settings1) → [Drive Mode].
- 2 Select the desired mode using the right/left side of the control wheel.

Menu item details

Single Shooting :

Normal shooting mode.

Cont. Shooting :

Shoots images continuously while you press and hold down the shutter button.

Self-timer :

Shoots an image using the self-timer after a designated number of seconds have elapsed since the shutter button was pressed.

Self-timer(Cont) :

Shoots a designated number of images using the self-timer after a designated number of seconds have elapsed since the shutter button was pressed.

Cont. Bracket :

Shoots images while holding the shutter button down, each with different degrees of exposure.

Single Bracket :

Shoots a specified number of images, one by one, each with a different degrees of exposure.

WB bracket :

Shoots a total of three images, each with different color tones according to the selected settings for white balance, color temperature and color filter.

DRO Bracket :

Shoots a total of three images, each at a different degree of D-Range Optimizer.

Note



- When the shooting mode is set to [Scene Selection] and [Sports Action] is selected, [Single Shooting] cannot be performed.

Related Topic

- [Cont. Shooting](#)
- [Self-timer](#)
- [Self-timer\(Cont\)](#)
- [Cont. Bracket](#)
- [Single Bracket](#)
- [WB bracket](#)
- [DRO Bracket](#)

Cont. Shooting

Shoots images continuously while you press and hold down the shutter button.

- 1 Select  /  (Drive Mode) of the control wheel → [Cont. Shooting].
 - You can also set the continuous shooting by selecting MENU →  1 (Camera Settings1) → [Drive Mode].
- 2 Select the desired mode using the right/left side of the control wheel.

Menu item details

Continuous Shooting: Hi+ :

Images are shot continuously at the maximum speed while you press and hold down the shutter button.

Continuous Shooting: Hi / Continuous Shooting: Mid / Continuous Shooting: Lo:

Subjects are easier to track because the subject is displayed in real-time on the monitor or viewfinder during shooting.

Hint

- To continuously adjust the focus and exposure during continuous shooting, set as follows:
 - [Focus Mode]: [Continuous AF]
 - [ AEL w/ shutter]: [Off] or [Auto]

Note



- The shooting speed during continuous shooting becomes slower when [e-Front Curtain Shutter] is set to [Off] in [Continuous Shooting: Hi], [Continuous Shooting: Mid] or [Continuous Shooting: Lo] mode.
- When the F-value is greater than F11 in [Continuous Shooting: Hi+], [Continuous Shooting: Hi] or [Continuous Shooting: Mid] mode, the focus is locked to the setting in the first shot.
- The subject is not displayed in real-time on the monitor or viewfinder when shooting in [Continuous Shooting: Hi+] mode.
- Continuous shooting is unavailable in the following situations:
 - The shooting mode is set to [Sweep Panorama].
 - The shooting mode is set to [Scene Selection] and a scene other than [Sports Action] is selected.
 - [Picture Effect] is set to one of the following: [Soft Focus] [HDR Painting] [Rich-tone Mono.] [Miniature] [Watercolor] [Illustration]
 - [DRO/Auto HDR] is set to [Auto HDR].
 - [ISO] is set to [Multi Frame NR].
 - [Smile Shutter] is being used.
- The speed of continuous shooting decreases when you shoot with a flash.

Related Topic

- [Focus Mode](#)
- [AEL w/ shutter \(still image\)](#)

Self-timer

Shoots an image using the self-timer after a designated number of seconds have elapsed since the shutter button was pressed. Use the 5-second/10-second self-timer when you are going to be in the picture, and use the 2-second self-timer to reduce camera-shake caused by pressing the shutter button.

- 1 Press  /  (Drive Mode) of the control wheel → [Self-timer].
 - You can also set the drive mode by selecting MENU →  1 (Camera Settings1) → [Drive Mode].

- 2 Select the desired mode using the right/left side of the control wheel.

- 3 Adjust the focus and shoot the image.

The self-timer lamp flashes, a beep sounds, and a picture is taken after the designated number of seconds have elapsed.

Menu item details







The mode determines the number of seconds until a picture is taken after the shutter button is pressed.

 10 Self-timer: 10 Sec

 5 Self-timer: 5 Sec

 2 Self-timer: 2 Sec

Hint

- Press the shutter button again or press  /  on the control wheel to stop the count of the self-timer.
- Press  /  on the control wheel and select  (Single Shooting) to cancel the self-timer.
- Set [Audio signals] to [Off] to turn off the beeping sound during the self-timer countdown.
- To use the self-timer in bracket mode, select bracket mode under drive mode, then select MENU →  1 (Camera Settings1) → [Bracket Settings] → [Selftimer during Bracket].

Note

- The self-timer is unavailable in the following situations:
 - The shooting mode is set to [Sweep Panorama].
 - [Sports Action] under [Scene Selection]
 - [Smile Shutter]



Related Topic

- [Audio signals](#)

Interchangeable Lens Digital Camera
ILCE-6100 α6100

Self-timer(Cont)

Shoots a designated number of images using the self-timer after a designated number of seconds have elapsed since the shutter button was pressed. You can choose the best from multiple shots.

- 1 Press  /  (Drive Mode) of the control wheel → [Self-timer(Cont)].
 - You can also set the drive mode by selecting MENU →  1 (Camera Settings1) → [Drive Mode].







- 2 Select the desired mode using the right/left side of the control wheel.

- 3 Adjust the focus and shoot the image.





The self-timer lamp flashes, a beep sounds, and pictures are taken after the designated number of seconds has elapsed. The designated number of pictures are taken continuously.

Menu item details

For example, three images are shot when 10 seconds have elapsed after the shutter button is pressed when [Self-timer(Cont.): 10 Sec. 3 Img.] is selected.

-  Self-timer(Cont.): 10 Sec. 3 Img.
-  Self-timer(Cont.): 10 Sec. 5 Img.
-  Self-timer(Cont.): 5 Sec. 3 Img.
-  Self-timer(Cont.): 5 Sec. 5 Img.
-  Self-timer(Cont.): 2 Sec. 3 Img.
-  Self-timer(Cont.): 2 Sec. 5 Img.



Hint

- Press the shutter button again or press  /  on the control wheel to stop the count of the self-timer.
- Press  /  on the control wheel and select  (Single Shooting) to cancel the self-timer.

Interchangeable Lens Digital Camera
ILCE-6100 α6100

Cont. Bracket

Shoots multiple images while automatically shifting the exposure from base to darker and then to lighter. You can select an image that suits your purpose after recording.

- 1 Press  /  (Drive Mode) of the control wheel → [Cont. Bracket].**
 - You can also set the drive mode by selecting MENU →  1 (Camera Settings1) → [Drive Mode].
- 2 Select the desired mode using the right/left side of the control wheel.**
- 3 Adjust the focus and shoot the image.**
 - The base exposure is set at the first shot.
 - Keep pressing and holding the shutter button until bracket shooting is finished.

Menu item details

For example, the camera shoots a total of three images continuously with an exposure value shifted by plus or minus 0.3 EV when [Cont. Bracket: 0.3EV 3 Image] is selected.

Note

- The last shot is shown on the auto review.
- When [ISO AUTO] is selected in [Manual Exposure] mode, the exposure is changed by adjusting the ISO value. If a setting other than [ISO AUTO] is selected, the exposure is changed by adjusting the shutter speed.
- When the exposure is compensated, the exposure is shifted based on the compensated value.
- Bracket shooting is unavailable in the following shooting modes:
 - [Intelligent Auto]
 - [Superior Auto]
 - [Scene Selection]
 - [Sweep Panorama]
- When the flash is used, the product performs flash bracket shooting, which shifts the amount of flash light even if [Cont. Bracket] is selected. Press the shutter button for each image.



Related Topic

- [Bracket Settings](#)
- [Indicator during bracket shooting](#)

Single Bracket

Shoots multiple images while automatically shifting the exposure from base to darker and then to lighter. You can select the image that suits your purpose after recording.

Since a single picture is taken each time you press the shutter button, you can adjust the focus or the composition for each shot.

- 1 Select  /  (Drive Mode) of the control wheel → [Single Bracket].**
 - You can also set the drive mode by selecting MENU →  1 (Camera Settings1) → [Drive Mode].
- 2 Select the desired mode using the right/left side of the control wheel.**
- 3 Adjust the focus and shoot the image.**
 - Press the shutter button for each image.

Menu item details

For example, when [Single Bracket: 0.3EV 3 Image] is selected, three images are shot one at a time with the exposure value shifted up and down in increments of 0.3 EV.

Note

- When [ISO AUTO] is selected in [Manual Exposure] mode, the exposure is changed by adjusting the ISO value. If a setting other than [ISO AUTO] is selected, the exposure is changed by adjusting the shutter speed.
- When the exposure is compensated, the exposure is shifted based on the compensated value.
- Bracket shooting is unavailable in the following shooting modes:
 - [Intelligent Auto]
 - [Superior Auto]
 - [Scene Selection]
 - [Sweep Panorama]

Related Topic

- [Bracket Settings](#)
- [Indicator during bracket shooting](#)

Interchangeable Lens Digital Camera
 ILCE-6100 α6100

Indicator during bracket shooting

Viewfinder

Ambient light* bracketing

3 images shifted by 0.3 EV steps

Exposure compensation ±0.0 EV

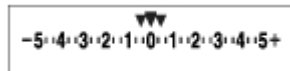

Monitor (Display All Info. or Histogram)

Ambient light* bracketing

3 images shifted by 0.3 EV steps

Exposure compensation ±0.0 EV

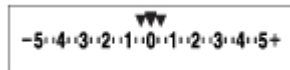

Flash bracketing

3 images shifted by 0.7 EV steps

Flash compensation -1.0 EV

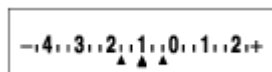

Monitor (For viewfinder)

Ambient light* bracketing (upper indicator)

3 images shifted by 0.3 EV steps

Exposure compensation ±0.0 EV

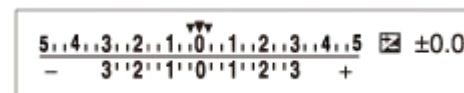

Flash bracketing (lower indicator)

3 images shifted by 0.7 EV steps

Flash compensation -1.0 EV



* Ambient light: A generic term for non-flash light including natural light, electric bulb and fluorescent lighting. Whereas the flash light blinks for a moment, ambient light is constant, so this kind of light is called "ambient light."



Note

- During bracket shooting, guides equal to the number of images to be shot are displayed over/under the bracket indicator.
- When you start single bracket shooting, the guides will disappear one by one as the camera records images.

Interchangeable Lens Digital Camera
ILCE-6100 α6100

WB bracket

Shoots a total of three images, each with different color tones according to the selected settings for white balance, color temperature and color filter.

- 1 Select  /  (Drive Mode) of the control wheel → [WB bracket].
 - You can also set the drive mode by selecting MENU →  1 (Camera Settings1) → [Drive Mode].
- 2 Select the desired mode using the right/left side of the control wheel.
- 3 Adjust the focus and shoot the image.

Menu item details

White Balance Bracket: Lo:

Records a series of three images with small changes in the white balance (within the range of 10MK⁻¹*).

White Balance Bracket: Hi:

Records a series of three images with large changes in the white balance (within the range of 20MK⁻¹*).

* MK⁻¹ is the unit that indicates the capability of color temperature conversion filters and indicates the same value as "mired."

Note



- The last shot is shown on the auto review.

Related Topic

- [Bracket Settings](#)

DRO Bracket

You can record a total of three images, each at a different degree of D-Range Optimizer value.

- 1 Select  /  (Drive Mode) of the control wheel → [DRO Bracket].
 - You can also set the drive mode by selecting MENU →  1 (Camera Settings1) → [Drive Mode].
- 2 Select the desired mode using the right/left side of the control wheel.
- 3 Adjust the focus and shoot the image.

Menu item details

DRO Bracket: Lo:

Records a series of three images with small changes in the D-Range Optimizer value (Lv 1, Lv 2, and Lv 3).

DRO Bracket: Hi:

Records a series of three images with large changes in the D-Range Optimizer value (Lv 1, Lv 3, and Lv 5).

Note





- The last shot is shown on the auto review.

Related Topic

- [Bracket Settings](#)

Bracket Settings

You can set the self-timer in bracket shooting mode, and the shooting order for exposure bracketing and white balance bracketing.

- 1 Select  /  (Drive Mode) of the control wheel → select bracket shooting mode.
 - You can also set the drive mode by selecting MENU →  1 (Camera Settings1) → [Drive Mode].
- 2 MENU →  1 (Camera Settings1) → [Bracket Settings] → desired setting.

Menu item details

Selftimer during Bracket:

Sets whether to use the self-timer during bracket shooting. Also sets the number of seconds until the shutter is released if using the self-timer.

(OFF/2 Sec/5 Sec/10 Sec)

Bracket order:

Sets the order of exposure bracketing and white balance bracketing.

(0→→+/-→0→+)

Related Topic

- [Cont. Bracket](#)
- [Single Bracket](#)
- [WB bracket](#)
- [DRO Bracket](#)

Interchangeable Lens Digital Camera
ILCE-6100 α6100

Self-portrait/ -timer

You can change the angle of the monitor and shoot images while watching the monitor.

- 1 MENU →  1 (Camera Settings1) → [Self-portrait/ -timer] → [On].
- 2 Tilt the monitor approximately 180° upward, and then point the lens at yourself.

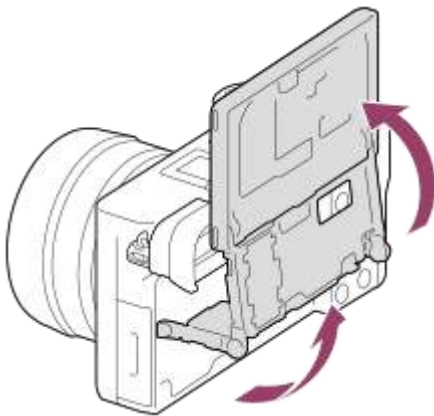

- 3 Press the shutter button. Alternatively, touch the subject on the monitor.

The product starts the self-timer shooting after three seconds.

Hint

- If you want to use another Drive Mode than the 3-second self-timer mode, first set [Self-portrait/ -timer] to [Off], then tilt the monitor upward approx. 180 degrees.





Interchangeable Lens Digital Camera
ILCE-6100 α6100

Interval Shoot Func.

You can automatically shoot a series of still images with the shooting interval and number of shots that you set in advance (Interval shooting). You can then create a movie from the still images produced by interval shooting using the computer software Imaging Edge (Viewer). You cannot create a movie from the still images on the camera.

For details on interval shooting, refer to the following URL:

<https://support.d-imaging.sony.co.jp/support/tutorial/ilc//ilce-6100/interval.php>

- 1 MENU →  1 (Camera Settings1) → [ Interval Shoot Func.] → [Interval Shooting] → [On].
- 2 MENU →  1 (Camera Settings1) → [ Interval Shoot Func.] → Select the item you want to set and the desired setting.
- 3 Press the shutter button.

When the time set for [Shooting Start Time] has elapsed, shooting will start.

 - When the number of shots set for [Number of Shots] is completed, the camera will return to the standby screen for interval shooting.

Menu item details

Interval Shooting:

Sets whether to perform interval shooting. ([On]/[Off])

Shooting Start Time:

Sets the time from when you press the shutter button to when interval shooting starts. (1 second to 99 minutes 59 seconds)

Shooting Interval:

Sets the shooting interval (time from when one exposure starts to when the exposure for the next shot starts). (1 second to 60 seconds)

Number of Shots:

Sets the number of shots for interval shooting. (1 shot to 9999 shots)

AE Tracking Sensitivity:

Sets the tracking sensitivity of the auto exposure against the change in luminance during interval shooting. If you select [Low], exposure changes during interval shooting will be smoother. ([High]/[Mid]/[Low])



Silent Shoot. in Interval:

Sets whether or not to perform silent shooting during interval shooting. ([On]/[Off])

Shoot Interval Priority:

Sets whether or not to prioritize the shooting interval when the exposure mode is [Program Auto] or [Aperture Priority] and the shutter speed becomes longer than the time set for [Shooting Interval]. ([On]/[Off])

Hint

- If you press the shutter button during interval shooting, interval shooting will end and the camera will return to the standby screen for interval shooting.
- To go back to the normal shooting mode, select MENU →  1 (Camera Settings1) → [ Interval Shoot Func.] → [Interval Shooting] → [Off].

- If you press a key to which one of the following functions has been assigned at the moment when shooting starts, the function will remain active during interval shooting even without you holding down the button.
 - [AEL hold]
 - [ AEL hold]
 - [AF/MF Control Hold]
- If you set [Display as Group] to [On], still images shot with the interval shooting function will be displayed in groups.
- Still images shot with interval shooting can be played back continuously on the camera. If you intend to create a movie using the still images, you can preview the result.

Note

- You may not be able to record the set number of images depending on the remaining battery level and the amount of free space on the recording medium. Supply power via USB while shooting, and use a memory card with sufficient space.
- When the shooting interval is short, the camera may get hot easily. Depending on the ambient temperature, you may not be able to record the set number of images because the camera may stop recording to protect the equipment.
- During interval shooting (including the time between pressing the shutter button and the start of shooting), you cannot operate the dedicated shooting setting screen or MENU screen. However, you can adjust some settings such as the shutter speed with using the customized dial or control wheel.
- During interval shooting, auto review is not displayed.
- [Silent Shoot. in Interval] is set to [On] in the default settings, regardless of the setting for [ Silent Shooting].
- Interval shooting is unavailable in the following situations:
 - The shooting mode is set to other than P/A/S/M

Related Topic

- [Imaging Edge](#)
- [Cont. PB for Interval](#)
- [Supplying power from a wall outlet \(wall socket\)](#)

Interchangeable Lens Digital Camera
ILCE-6100 α6100

Touch Operation

Sets whether or not to activate touch operations on the monitor.

1 MENU →  (Setup) → [Touch Operation] → desired setting.

Menu item details

On:

Activates the touch operation.

Off:

Deactivates the touch operation.

Related Topic

- [Func. of Touch Operation: Touch Shutter](#)
- [Func. of Touch Operation: Touch Focus](#)
- [Func. of Touch Operation: Touch Tracking](#)
- [Touch Pad Settings](#)
- [Touch Panel/Pad](#)

Interchangeable Lens Digital Camera
ILCE-6100 α6100

Touch Panel/Pad

Touch operations when shooting with the monitor are referred to as "touch panel operations," and touch operations when shooting with the viewfinder are referred to as "touch pad operations." You can select whether to activate touch panel operations or touch pad operations.

① MENU →  (Setup) → [Touch Panel/Pad] → desired setting.

Menu item details

Touch Panel+Pad:

Activates both the touch panel operations when shooting with the monitor and touch pad operations when shooting with the viewfinder.

Touch Panel Only:

Activates only the touch panel operations when shooting with the monitor.

Touch Pad Only:

Activates only the touch pad operations when shooting with the viewfinder.

Related Topic

- [Touch Operation](#)

Interchangeable Lens Digital Camera
ILCE-6100 α6100

Func. of Touch Operation: Touch Shutter

When you shoot using the monitor, the camera automatically focuses on the point you touch and shoots a still image. Set MENU →  (Setup) → [Touch Operation] to [On] in advance.

1 Select MENU →  (Camera Settings2) → [Func. of Touch Operation] → [Touch Shutter].

2 Touch the  icon inside the rectangle in the top right of the monitor while the shooting screen is displayed.

The mark to the left of the icon turns orange, and the touch shutter function is activated.

- To cancel [Touch Shutter], touch the  icon again.
- The touch shutter function is canceled when the camera is restarted.

3 Touch the subject to focus on.

When the subject you touched is in focus, a still image is recorded.

Hint

- You can operate the shooting functions below by touching the monitor:
 - Shooting burst images using the touch shutter
When [Drive Mode] is set to [Cont. Shooting], you can record burst images while touching the monitor.
 - Shooting burst images of sports scenes using the touch shutter
When [Scene Selection] is set to [Sports Action], you can record burst images while touching the monitor.
 - Shooting continuous bracket images using the touch shutter
The product shoots three images while automatically shifting the exposure from base, to darker, and then to lighter. When [Drive Mode] is set to [Cont. Bracket], keep touching the monitor until the shooting ends. After the recording you can select the image you prefer.

Note

- The [Touch Shutter] function is unavailable in the following situations:
 - During viewfinder shooting
 - When the shooting mode is set to [Movie]
 - When the shooting mode is set to [S&Q Motion]
 - When the shooting mode is set to [Sweep Panorama]
 - During [Smile Shutter] mode
 - When [Focus Mode] is [Manual Focus]
 - When [Focus Area] is [Flexible Spot]
 - When [Focus Area] is [Expand Flexible Spot]
 - When [Focus Area] is [Tracking: Flexible Spot]
 - When [Focus Area] is [Tracking: Expand Flexible Spot]
 - While using the digital zoom function
 - While using the  Clear Image Zoom]

Related Topic

- [Touch Operation](#)

5-009-879-12(1) Copyright 2019 Sony Corporation

Interchangeable Lens Digital Camera
ILCE-6100 α6100

Func. of Touch Operation: Touch Focus

[Touch Focus] allows you to specify a position where you want to focus using touch operations. This function is available when [Focus Area] is set to a parameter other than [Flexible Spot], [Expand Flexible Spot], [Tracking: Flexible Spot] or [Tracking: Expand Flexible Spot]. Select MENU →  (Setup) → [Touch Operation] → [On] beforehand.

1 MENU →  2 (Camera Settings2) → [Func. of Touch Operation] → [Touch Focus].

Specifying the position where you want to focus in the still image mode

You can specify a position where you want to focus using touch operations. After touching the monitor and specifying a position, press the shutter button halfway down to focus.

1. Touch the monitor.

- When shooting with the monitor, touch the position where you want to focus.
- When shooting with the viewfinder, you can move the position of the focus by touching and dragging on the monitor while looking through the viewfinder.

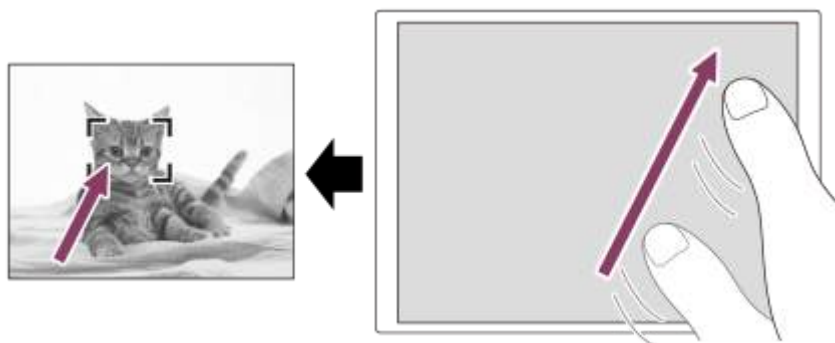

- To cancel focusing with touch operations, touch  or press the center of the control wheel if shooting with the monitor, and press the center of the control wheel if shooting with the viewfinder.

2. Press the shutter button halfway down to focus.

- Press the shutter button all the way down to shoot images.

Specifying the position where you want to focus in the movie recording mode (spot focus)

The camera will focus on the touched subject. Spot focus is not available when shooting with the viewfinder.

1. Touch the subject on which you want to focus before or during recording.

- When you touch the subject, the focus mode temporarily switches to manual focus and the focus can be adjusted using the focus ring.
- To cancel spot focus, touch  or press the center of the control wheel.

Hint

- In addition to the touch focus function, touch operations such as the following are also available.
 - When [Focus Area] is set to [Flexible Spot], [Expand Flexible Spot], [Tracking: Flexible Spot] or [Tracking: Expand Flexible Spot], the focusing frame can be moved using touch operations.
 - When the [Focus Mode] is set to [Manual Focus], the focus magnifier can be used by double-tapping the monitor.

Note

- The touch focus function is not available in the following situations:
 - When the shooting mode is set to [Sweep Panorama].
 - When [Focus Mode] is set to [Manual Focus].
 - When using the digital zoom
 - When using the LA-EA2 or LA-EA4

Related Topic

- [Touch Operation](#)
- [Touch Panel/Pad](#)

5-009-879-12(1) Copyright 2019 Sony Corporation

Func. of Touch Operation: Touch Tracking

You can use touch operations to select a subject you want to track in the still image and movie recording modes.
Select MENU →  (Setup) → [Touch Operation] → [On] in advance.

1 MENU →  2 (Camera Settings2) → [Func. of Touch Operation] → [Touch Tracking].

2 Touch the subject that you want to track on the monitor.

Tracking will start.

3 Press the shutter button halfway down to focus.

- Press the shutter button all the way down to shoot images.

Hint

- To cancel tracking, touch  or press the center of the control wheel.

Note

- [Touch Tracking] is unavailable in the following situations:
 - When [Scene Selection] is [Hand-held Twilight] or [Anti Motion Blur].
 - When shooting movies with [ Record Setting] set to [120p]/[100p].
 - When shooting mode is set to [Sweep Panorama].
 - When [Focus Mode] is set to [Manual Focus].
 - When using the Smart Zoom, Clear Image Zoom and Digital Zoom
 - When using the LA-EA2 or LA-EA4 Mount Adaptor
 - When [Subject Detection] under [Face/Eye AF Set.] is set to [Animal]

Related Topic

- [Touch Operation](#)

Touch Pad Settings

You can adjust settings related to touch pad operations during viewfinder shooting.

1 MENU →  (Setup) → [Touch Pad Settings] → desired setting.

Menu item details

Operation in Vertical Orientation :

Sets whether to enable touch pad operations during vertically oriented viewfinder shooting. You can prevent erroneous operations during vertically oriented shooting caused by your nose, etc. touching the monitor.

Touch Position Mode:

Sets whether to move the focusing frame to the position touched on the screen ([Absolute Position]), or move the focusing frame to the desired position based on the direction of dragging and the amount of movement ([Relative Position]).

Operation Area:

Sets the area to be used for touch pad operations. Restricting the operational area can prevent erroneous operations caused by your nose, etc. touching the monitor.

About Touch Positioning Mode

Selecting [Absolute Position] lets you move the focusing frame to a distant position more quickly because you can directly specify the position of the focusing frame with touch operations.

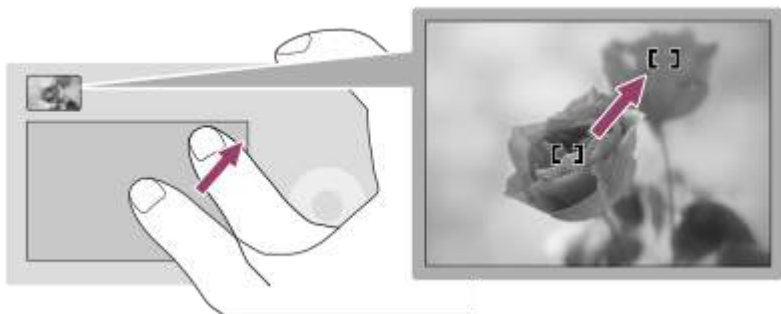

Selecting [Relative Position] lets you operate the touch pad from wherever is easiest, without having to move your finger over a wide area.

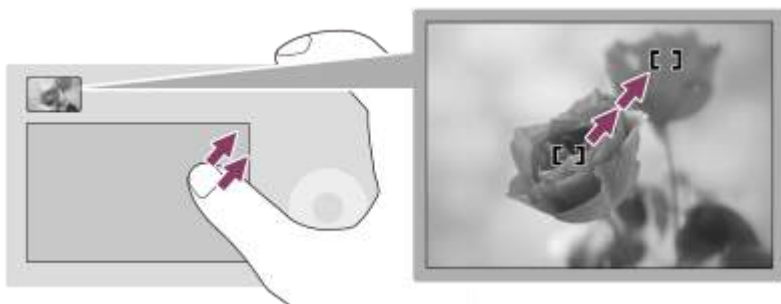

Hint

- In touch pad operations when [Touch Position Mode] is set to [Absolute Position], the area set in [Operation Area] is treated as the entire screen.

Related Topic



- [Touch Operation](#)

5-009-879-12(1) Copyright 2019 Sony Corporation

Interchangeable Lens Digital Camera
ILCE-6100 α6100

File Format (still image)

Sets the file format for still images.

1 MENU →  1 (Camera Settings1) → [ File Format] → desired setting.

Menu item details

RAW:

Digital processing is not performed on this file format. Select this format to process images on a computer for professional purposes.



RAW & JPEG:

A RAW image and a JPEG image are created at the same time. This is suitable when you need two image files, a JPEG for viewing, and a RAW for editing.

JPEG:

The image is recorded in the JPEG format.

About RAW images

- To open a RAW image file recorded with this camera, the software Imaging Edge is needed. With Imaging Edge, you can open a RAW image file, then convert it into a popular image format such as JPEG or TIFF, or readjust the white balance, saturation or contrast of the image.
- You cannot apply [Auto HDR] or [Picture Effect] functions with RAW images.
- RAW images shot by the camera are recorded in the compressed RAW format.
- RAW images recorded with this camera have a resolution of 14 bits per pixel. However, resolution is limited to 12 bits in the following shooting modes:
 - [ Long Exposure NR]
 - [BULB]
 - [Cont. Shooting] (including continuous shooting in [Superior Auto] mode)
 - [ Silent Shooting]

Note

- If you do not intend to edit the images on your computer, we recommend that you record in JPEG format.
- You cannot add DPOF (print order) registration marks to RAW images.



Related Topic

- [JPEG Image Size \(still image\)](#)

Interchangeable Lens Digital Camera
ILCE-6100 α6100

JPEG Quality (still image)

Selects the JPEG image quality when [ File Format] is set to [RAW & JPEG] or [JPEG].

① MENU →  1 (Camera Settings1) → [ JPEG Quality] → desired setting.

Menu item details

Extra fine/Fine/Standard:

Since the compression rate increases from [Extra fine] to [Fine] to [Standard], the file size decreases in the same order. This allows more files to be recorded on one memory card, but the image quality is lower.



Related Topic

- [File Format \(still image\)](#)

Interchangeable Lens Digital Camera
ILCE-6100 α6100

JPEG Image Size (still image)

The larger the image size, the more detail will be reproduced when the image is printed on large-format paper. The smaller the image size, the more images can be recorded.

① MENU →  1 (Camera Settings1) → [ JPEG Image Size] → desired setting.

Menu item details

When [ Aspect Ratio] is set to 3:2	
L: 24M	6000×4000 pixels
M: 12M	4240×2832 pixels
S: 6.0M	3008×2000 pixels

When [ Aspect Ratio] is set to 16:9	
L: 20M	6000×3376 pixels
M: 10M	4240×2400 pixels
S: 5.1M	3008×1688 pixels

When [ Aspect Ratio] is set to 1:1	
L: 16M	4000×4000 pixels
M: 8.0M	2832×2832 pixels
S: 4.0M	2000×2000 pixels

Note



- When [ File Format] is set to [RAW] or [RAW & JPEG], the image size for RAW images corresponds to “L.”

Related Topic

- [Aspect Ratio \(still image\)](#)

Interchangeable Lens Digital Camera
ILCE-6100 α6100

Aspect Ratio (still image)

① MENU →  1 (Camera Settings1) → [ Aspect Ratio] → desired setting.

Menu item details

3:2:

Same aspect ratio as 35 mm film

16:9:

The aspect ratio is 16:9.

1:1:

The horizontal and vertical ratio is equal.

Interchangeable Lens Digital Camera
ILCE-6100 α6100

Panorama: Size

Sets the image size when shooting panoramic images. The image size varies depending on the [Panorama: Direction] setting.

① MENU →  1 (Camera Settings1) → [Panorama: Size] → desired setting.

Menu item details

When [Panorama: Direction] is set to [Up] or [Down]

Standard: 3872×2160

Wide: 5536×2160

When [Panorama: Direction] is set to [Left] or [Right]

Standard: 8192×1856

Wide: 12416×1856

Related Topic

- [Sweep Panorama](#)
- [Panorama: Direction](#)

Interchangeable Lens Digital Camera
ILCE-6100 α6100

Panorama: Direction

Sets the direction to pan the camera when shooting panoramic images.

① MENU →  1 (Camera Settings1) → [Panorama: Direction] → desired setting.

Menu item details

Right:

Pan the camera from the left to the right.

Left:

Pan the camera from the right to the left.

Up:

Pan the camera from the bottom to the top.

Down:

Pan the camera from the top to the bottom.

Related Topic

- [Sweep Panorama](#)

Interchangeable Lens Digital Camera
ILCE-6100 α6100

List of mode dial function

You can switch the shooting mode according to the subject or purpose of shooting.

- 1 Turn the mode dial to select the desired shooting mode.

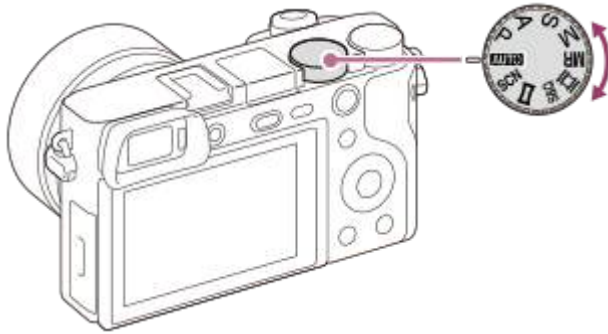

Available functions

AUTO (Auto Mode):

Allows you to shoot still images of any subject under any condition with good results by setting the values determined appropriate by the product.

P (Program Auto):

Allows you to shoot with the exposure adjusted automatically (both the shutter speed and the aperture value (F value)). Also you can select various settings using the menu.

A (Aperture Priority):

Allows you to adjust the aperture and shoot when you want to blur the background, etc.

S (Shutter Priority):

Allows you to shoot fast-moving subjects etc., by manually adjusting the shutter speed.

M (Manual Exposure):

Allows you to shoot still images with the desired exposure by adjusting the exposure (both the shutter speed and the aperture value (F value)).

MR (Memory recall):

Allows you to shoot an image after recalling often-used modes or numeric settings registered in advance.

(Movie):

Allows you to change the exposure mode for movie recording.

S&Q (S&Q Motion):

Allows you to shoot slow-motion and quick-motion movies.

(Sweep Panorama):

Allows you to shoot a panoramic image by compositing the images.

SCN (Scene Selection):

Allows you to shoot with preset settings according to the scene.

Related Topic

- [Intelligent Auto](#)
- [Superior Auto](#)
- [Program Auto](#)
- [Aperture Priority](#)

- Shutter Priority
- Manual Exposure
- Recall (Camera Settings1/Camera Settings2)
- Movie: Exposure Mode
- S&Q Motion: Exposure Mode
- Sweep Panorama
- Scene Selection

5-009-879-12(1) Copyright 2019 Sony Corporation

Intelligent Auto

The camera shoots with automatic scene recognition.

- 1 Set the mode dial to **AUTO** (Auto Mode).
- 2 MENU →  (Camera Settings1) → [Auto Mode] → [Intelligent Auto].
- 3 Point the camera at the subject.

When the camera recognized the scene, the icon for the recognized scene appears on the screen.



- 4 Adjust the focus and shoot the image.

Note

- The product will not recognize the scene when you shoot images with zoom functions other than optical zoom.
- The product may not properly recognize the scene under certain shooting conditions.
- For [Intelligent Auto] mode, most of the functions are set automatically, and you cannot adjust the settings on your own.

Related Topic

- [Switching the auto mode \(Auto Mode\)](#)
- [About Scene Recognition](#)
- [Mode Dial Guide](#)

Superior Auto

The camera shoots with automatic scene recognition. This mode takes clear images of dark or backlit scenes.

For low-lit or backlit scenes, if necessary the camera may shoot multiple images and create a composite image, etc., to record higher quality images than in Intelligent Auto mode.

- 1 Set the mode dial to **AUTO** (Auto Mode).
- 2 MENU →  1 (Camera Settings1) → [Auto Mode] → [Superior Auto].
- 3 Point the camera to the subject.

When the camera recognizes a scene, scene recognition icon appears on the screen. If necessary, appropriate shooting function for the recognized scene and the number of times the shutter is released also appear.

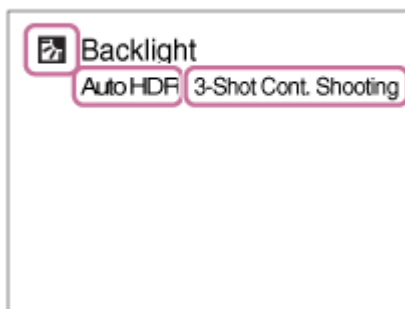

- 4 Adjust the focus and shoot the image.
When the camera shoots multiple images, it automatically chooses and saves the appropriate image. You can also save all the images by setting the [Superior Auto Img. Extract.].

Note

- When the product is used to create composite images, the recording process takes longer than usual. In this case, the shutter sound is heard multiple times, but only one image is recorded.
- The product will not recognize the scene when you use zoom functions other than optical zoom.
- The product may not properly recognize a scene under some shooting conditions.
- When [ File Format] is set to [RAW] or [RAW & JPEG], the product cannot create a composite image.
- For [Superior Auto] mode, most of the functions are set automatically, and you cannot adjust the settings on your own.

Related Topic

- [Switching the auto mode \(Auto Mode\)](#)
- [Mode Dial Guide](#)
- [About Scene Recognition](#)

Interchangeable Lens Digital Camera
ILCE-6100 α6100

Superior Auto Img. Extract.

Sets whether or not to save all the images that were shot continuously in [Superior Auto].

① MENU →  1 (Camera Settings1) → [Superior Auto Img. Extract.] → desired setting.

Menu item details

Auto:

Saves one appropriate image selected by the product.

Off:

Saves all of the images.

Note

- Even if you set [Superior Auto Img. Extract.] to [Off] with [Hand-held Twilight] selected as the scene recognition mode, one combined image is saved.
- When the Auto Framing function is activated, two images are saved even if you set [Superior Auto Img. Extract.] to [Auto].
- When [ Quality] is set to [RAW] or [RAW & JPEG], the shooting function will be limited.

Interchangeable Lens Digital Camera
ILCE-6100 α6100

Switching the auto mode (Auto Mode)

This camera is equipped with the following two automatic shooting modes: [Intelligent Auto] and [Superior Auto]. You can switch the auto mode to shoot according to the subject and your preferences.

- 1 Set the mode dial to **AUTO**.
- 2 MENU →  1 (Camera Settings1) → [Auto Mode] → desired setting.

Menu item details

Intelligent Auto:

Allows you to shoot with automatic scene recognition.

Superior Auto:

Allows you to shoot with automatic scene recognition. This mode takes clear images of dark or backlit scenes.

Note

- In [Superior Auto] mode, the recording process takes longer, since the product creates a composite image. In this case, the shutter sound is heard multiple times, but only one image is recorded.
- For [Intelligent Auto] and [Superior Auto] mode, most of the functions are set automatically, and you cannot adjust the settings on your own.

Related Topic

- [Intelligent Auto](#)
- [Superior Auto](#)

Interchangeable Lens Digital Camera
ILCE-6100 α6100

About Scene Recognition

Scene Recognition operates in [Intelligent Auto] mode and [Superior Auto] mode.

This function allows the product to automatically recognize the shooting conditions and shoot the image.

Scene Recognition

When the product recognizes certain scenes, the following icons and guides are displayed on the first line:













-  (Portrait)
-  (Infant)
-  (Night Portrait)
-  (Night Scene)
-  (Backlight Portrait)
-  (Backlight)
-  (Landscape)
-  (Macro)
-  (Spotlight)
-  (Low Light)
-  (Night Scene using a tripod)
-  (Hand-held Twilight)

Image processing

[Cont. Shooting]/[Slow Sync.]/[Auto HDR]/[Daylight Sync.]/[Slow Shutter]/[Hand-held Twilight]

Related Topic

- [Intelligent Auto](#)
- [Superior Auto](#)

Interchangeable Lens Digital Camera
ILCE-6100 α6100

Program Auto

Allows you to shoot with the exposure adjusted automatically (both the shutter speed and the aperture value).

You can set shooting functions such as [ISO].

- 1 **Set the mode dial to P (Program Auto).**
- 2 **Set the shooting functions to your desired settings.**
- 3 **Adjust the focus and shoot the subject.**

Program Shift

When you are not using a flash, you can change the shutter speed and aperture (F-value) combination without changing the appropriate exposure set by the camera.

Turn the control dial to select the aperture value and shutter speed combination.

- “P” on the screen changes to “P*” when you turn the control dial.
- To cancel program shift, set the shooting mode to other than [Program Auto], or turn off the camera.

Note

- According to the brightness of the environment, the program shift may not be used.
- Set the shooting mode to another one than “P” or turn off the power to cancel the setting you made.
- When the brightness changes, the aperture (F-value) and shutter speed also change while maintaining the shift amount.

Aperture Priority

You can shoot by adjusting the aperture and changing the range in focus, or by defocusing the background.

1 Set the mode dial to A (Aperture Priority).

2 Select the desired value by turning the control dial.

- Smaller F-value: The subject is in focus, but objects in front of and beyond the subject are blurred.
Larger F-value: The subject and its foreground and background are all in focus.
- If the aperture value you have set is not suitable for appropriate exposure, the shutter speed on the shooting screen will blink. If this happens, change the aperture value.

3 Adjust the focus and shoot the subject.

The shutter speed is automatically adjusted to obtain proper exposure.

Note

- The brightness of the image on the screen may differ from the actual image being shot.

Related Topic

- [Aperture Preview](#)

Interchangeable Lens Digital Camera
ILCE-6100 α6100

Shutter Priority

You can express the movement of a moving subject in various ways by adjusting the shutter speed, for example, at the instant of the movement with high speed shutter, or as a trailing image with low speed shutter.

1 Set the mode dial to S (Shutter Priority).

2 Select the desired value by turning the control dial.

- If proper exposure cannot be obtained after setup, the aperture value on the shooting screen blinks. If this happens, change the shutter speed.

3 Adjust the focus and shoot the subject.

The aperture is automatically adjusted to obtain proper exposure.

Hint

- Use a tripod to prevent camera-shake when you have selected a slow shutter speed.
- When you shoot indoor sports scenes, set the ISO sensitivity to a higher value.

Note

- The SteadyShot warning indicator does not appear in shutter speed priority mode.
- When [ Long Exposure NR] is set to [On] and the shutter speed is 1 second(s) or longer, noise reduction will be done after shooting for the same amount of time that the shutter was open. However, you cannot shoot any more while noise reduction is in progress.
- The brightness of the image on the screen may differ from the actual image being shot.

Related Topic

- [Long Exposure NR \(still image\)](#)

Manual Exposure

You can shoot with the desired exposure setting by adjusting both the shutter speed and aperture.

1 Set the mode dial to M (Manual Exposure).

**2 Select the desired shutter speed by turning the control wheel.
Select the desired aperture value by turning the control dial.**

- You can switch the functions of the control dial and the control wheel using MENU →  2 (Camera Settings2) → [Dial/Wheel Setup].
- You can also set [ISO] to [ISO AUTO] in manual exposure mode. The ISO value automatically changes to achieve the appropriate exposure using the aperture value and shutter speed you have set.
- When [ISO] is set to [ISO AUTO], the ISO value indicator will blink if the value you have set is not suitable for appropriate exposure. If this happens, change the shutter speed or aperture value.
- When [ISO] is set to other than [ISO AUTO], use MM (Metered Manual)* to check the exposure value.
Toward +: Images become brighter.
Toward -: Images become darker.
0: Appropriate exposure analyzed by the product.

* Indicates under/over for appropriate exposure. It is displayed using a numerical value on the monitor and with a metering indicator on the viewfinder.

3 Adjust the focus and shoot the subject.

Hint

- By rotating the control dial while pressing the AEL button, you can change the shutter speed and aperture (F-value) combination without changing the set exposure value. (Manual shift)

Note

- The Metered Manual indicator does not appear when [ISO] is set to [ISO AUTO].
- When the amount of ambient light exceeds the metering range of the Metered Manual, the Metered Manual indicator flashes.
- The SteadyShot warning indicator does not appear in manual exposure mode.
- The brightness of the image on the screen may differ from the actual image being shot.

Interchangeable Lens Digital Camera
ILCE-6100 α6100

Bulb shooting

You can shoot a trailing image of the movement of a subject with long exposure. Bulb shooting is suitable for shooting trails from stars or fireworks, etc.



- 1 **Set the mode dial to M (Manual Exposure).**
- 2 **Turn the control wheel counterclockwise until [BULB] is indicated.**
- 3 **Set the aperture value (F-value) by turning the control dial.**
- 4 **Press the shutter button halfway down to focus.**
- 5 **Press and hold the shutter button for the duration of the shooting.**

As long as the shutter button is pressed, the shutter remains open.

Hint

- When shooting fireworks, etc., focus at infinity in manual focus mode. If you use a lens whose infinity point is unclear, adjust the focus on the fireworks in the area you want to focus on in advance.
- In order to perform bulb shooting without causing the image quality to deteriorate, we recommend that you start shooting while the camera is cool.
- During bulb shooting, images tend to blur. It is recommended that you use a tripod, a RMT-P1BT Bluetooth remote commander (sold separately) or a remote commander equipped with a lock function (sold separately). When using the RMT-P1BT Bluetooth remote commander, you can start bulb shooting by pressing the shutter button on the remote commander. To stop bulb shooting, press the shutter button on the remote commander again. To use the other remote commander, use the model which can be connected via the Multi/Micro USB terminal.

Note

- The longer the exposure time, the more noise will be visible on the image.
- When [ Long Exposure NR] is set to [On], noise reduction is performed after shooting for the same duration that the shutter was open. You cannot shoot while noise reduction is in progress.
- You cannot set the shutter speed to [BULB] in the following situations:
 - [Smile Shutter]
 - [Auto HDR]
 - [Picture Effect] is set to [HDR Painting] or [Rich-tone Mono.].
 - [Multi Frame NR]
 - When [Drive Mode] is set to the following:
 - [Cont. Shooting]
 - [Self-timer(Cont)]
 - [Cont. Bracket]
 - [ Silent Shooting]

If you use the above functions when the shutter speed is set to [BULB], the shutter speed is temporarily set to 30 seconds.

Related Topic

- [Manual Exposure](#)

5-009-879-12(1) Copyright 2019 Sony Corporation

Interchangeable Lens Digital Camera
ILCE-6100 α6100

Sweep Panorama

Allows you to create a single panoramic image from multiple images shot while panning the camera.



- 1 Set the mode dial to  (Sweep Panorama).
- 2 Point the camera at the subject.
- 3 While pressing the shutter button halfway down, aim the camera at one end of the desired panoramic composition.
 - You can change the shooting direction prior to shooting using the control dial.

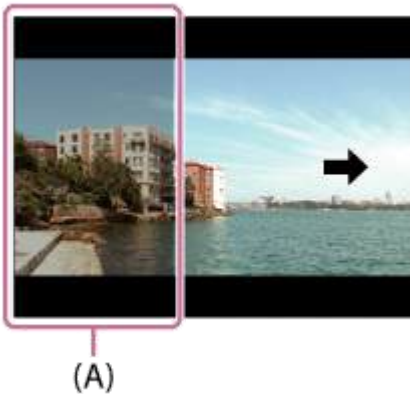

(A) This part will not be shot.



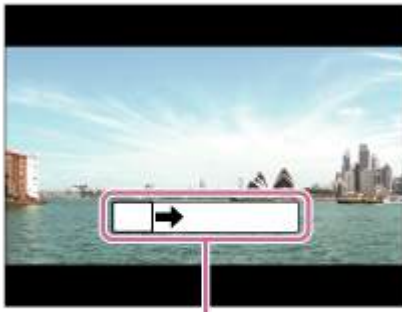

- 4 Press the shutter button fully down.
- 5 Pan the camera to the end of the guide in the direction of the arrow on the monitor.



(B)

(B) Guidance bar

Note

- If the entire angle of the panoramic shot is not achieved within the set time, a gray area occurs in the composite image. If this happens, move the product faster to record the full panoramic image.
- When [Wide] is selected for [Panorama: Size], the entire angle of the panoramic shot may not be achieved within the given time. If this happens, try shooting after changing [Panorama: Size] to [Standard].
- Since several images are stitched together, the stitched part may not be recorded smoothly in some cases.
- When a light source such as a fluorescent light flickers, the brightness and color of a stitched image may not be consistent.
- When the whole angle of panoramic shooting and the AE/AF locked angle are very different in brightness and focus, the shooting may not be successful. If this happens, change AE/AF locked angle and shoot again.
- The following situations are not suited for shooting Sweep Panorama:
 - Moving subjects.
 - Subjects that are too close to the product.
 - Subjects with continuously similar patterns, such as the sky, beach, or a lawn.
 - Subjects with constant change such as waves or water falls.
 - Subjects with brightness widely different from its surroundings such as the sun or a light bulb.
- The Sweep Panorama shooting may be interrupted in the following situations:
 - When the camera is panned too fast or too slow.
 - When the camera shakes too much.
- Continuous shooting is performed during shooting Sweep Panorama and the shutter sound keeps beeping until shooting is finished.
- The following functions are not available with Sweep Panorama:
 - Smile Shutter
 - Face/Eye Priority in AF
 - Face Priority in Multi Metering
 -  Auto Object Framing
 - DRO/Auto HDR
 - Picture Effect
 -  Soft Skin Effect
 -  Long Exposure NR
 - Tracking function
 - Other zoom functions than the optical zoom
 - Drive Mode
 - Bright Monitoring
- The values of the settings for some functions are fixed with Sweep Panorama, as follows:
 - [ISO] is fixed to [ISO AUTO].
 - [Focus Area] is fixed to [Wide].
 - [ High ISO NR] is fixed to [Normal].
 - [Flash Mode] is fixed to [Flash Off].

Related Topic

- [Panorama: Size](#)
- [Panorama: Direction](#)

5-009-879-12(1) Copyright 2019 Sony Corporation

Interchangeable Lens Digital Camera
ILCE-6100 α6100

Scene Selection

Allows you to shoot with preset settings according to the scene.

- 1 Set the mode dial to SCN (Scene Selection).
- 2 Turn the control dial to select the desired setting.

Menu item details

Portrait:

Blurs background and sharpens the subject. Accentuates the skin tones softly.



Sports Action:

Shoots a moving subject at a fast shutter speed so that the subject looks as if it is standing still. The product shoots images continuously while the shutter button is pressed.



Macro:

Shoots close-ups of the subjects, such as flowers, insects, food, or small items.



Landscape:

Shoots the entire range of a scenery in sharp focus with vivid colors.



Sunset:

Shoots the red of the sunset beautifully.



🌙 Night Scene:

Shoots night scenes without losing the dark atmosphere.



👋 Hand-held Twilight:

Shoots night scenes with less noise and blur without using a tripod. A burst of shots are taken, and image processing is applied to reduce subject blur, camera-shake, and noise.



👤🌙 Night Portrait:

Shoots night scene portraits using the flash.

The flash does not pop up automatically. Pop up the flash manually before shooting.



👤👤 Anti Motion Blur:

Allows you to shoot indoor shots without using the flash and reduces subject blur. The product shoots burst images and combines them to create the image, reducing subject blur and noise.



Hint

- To change the scene, rotate the control dial on the shooting screen and select a new scene.

Note

- Under the following settings, the shutter speed is slower, so use of a tripod, etc. is recommended to prevent the image from blurring:
 - [Night Scene]
 - [Night Portrait]
- In the [Hand-held Twilight] or [Anti Motion Blur] mode, the shutter clicks 4 times and an image is recorded.
- If you select [Hand-held Twilight] or [Anti Motion Blur] with [RAW] or [RAW & JPEG], [📷 File Format] becomes [JPEG] temporarily.

- Reducing blur is less effective even in [Hand-held Twilight] or [Anti Motion Blur] when shooting the following subjects:
 - Subjects with erratic movement.
 - Subjects that are too close to the product.
 - Subjects with continuously similar patterns, such as the sky, a beach, or a lawn.
 - Subjects with constant change such as waves or water falls.
- In the case of [Hand-held Twilight] or [Anti Motion Blur], block noise may occur when using a light source that flickers, such as fluorescent lighting.
- The minimum distance that you can come close to a subject does not change even if you select [Macro]. For the minimum in-focus range, refer to the minimum distance of the lens attached to the product.



Related Topic



- [Using flash](#)

5-009-879-12(1) Copyright 2019 Sony Corporation

Interchangeable Lens Digital Camera
ILCE-6100 α6100

Recall (Camera Settings1/Camera Settings2)



Allows you to shoot an image after recalling often-used modes or camera settings registered with [**MR**   Memory] in advance.

- 1 Set the mode dial to MR (Memory recall).
- 2 Press the left/right side of the control wheel or turn the control wheel to select the desired number, then press the center of the control wheel.
 - You can also recall registered modes or settings by selecting MENU →  1 (Camera Settings1) → [**MR**   Recall].

Hint

- To recall settings registered to the memory card, set the mode dial to MR (Memory recall), then select the desired number by pressing the left/right side of the control wheel.
- Settings registered to a memory card using another camera of the same model name can be recalled with this camera.

Note

- If you set [**MR**   Recall] after completing the shooting settings, the registered settings are given priority and the original settings may become invalid. Check the indicators on the screen before shooting.



Related Topic

- [Memory \(Camera Settings1/Camera Settings2\)](#)

Interchangeable Lens Digital Camera
ILCE-6100 α6100

Movie: Exposure Mode

You can set the exposure mode for movie shooting.

- 1 Set the mode dial to  (Movie).
- 2 MENU →  (Camera Settings2) → [ Exposure Mode] → desired setting.
- 3 Press the MOVIE (movie) button to start recording.
 - Press the MOVIE button again to stop recording.

Menu item details

Program Auto:

Allows you to shoot with the exposure adjusted automatically (both the shutter speed and the aperture value).

Aperture Priority:

Allows you to shoot after adjusting the aperture value manually.

Shutter Priority:

Allows you to shoot after adjusting the shutter speed manually.

Manual Exposure:

Allows you to shoot after adjusting the exposure (both the shutter speed and the aperture value) manually.

Interchangeable Lens Digital Camera
ILCE-6100 α6100

S&Q Motion: Exposure Mode

You can select the exposure mode for slow-motion/quick-motion shooting. You can change the setting and playback speed for slow-motion/quick-motion shooting with [**S&Q** S&Q Settings].

- 1 Set the mode dial to **S&Q** (S&Q Motion).
- 2 MENU →  (Camera Settings2) → [**S&Q** Exposure Mode] → desired setting.
- 3 Press the MOVIE (movie) button to start recording.
 - Press the MOVIE button again to stop recording.

Menu item details

S&Q P Program Auto:

Allows you to shoot with the exposure adjusted automatically (both the shutter speed and the aperture value).

S&Q A Aperture Priority:

Allows you to shoot after adjusting the aperture value manually.

S&Q S Shutter Priority:

Allows you to shoot after adjusting the shutter speed manually.

S&Q M Manual Exposure:

Allows you to shoot after adjusting the exposure (both the shutter speed and the aperture value) manually.

Related Topic

- [S&Q Settings](#)

Interchangeable Lens Digital Camera
ILCE-6100 α6100

Exposure Comp.

Normally, exposure is set automatically (auto exposure). Based on the exposure value set by auto exposure, you can make the entire image brighter or darker if you adjust [Exposure Comp.] to the plus side or minus side, respectively (exposure compensation).

- 1  (Exposure Comp.) on the control wheel → press the left/right side of the control wheel or turn the control wheel, and select the desired setting.

+ (over) side:

Images become brighter.

- (under) side:

Images become darker.

- You can also select MENU →  1 (Camera Settings1) → [Exposure Comp.].
- You can adjust the exposure compensation value within the range of -5.0 EV to +5.0 EV.
- You can confirm the exposure compensation value that you set on the shooting screen.

Monitor

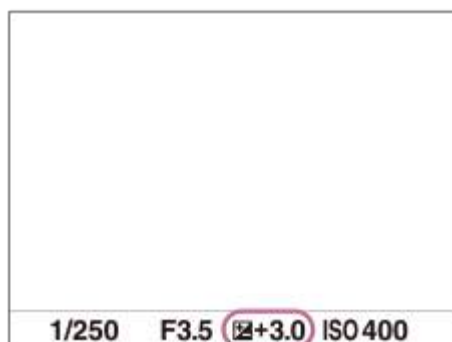

Viewfinder



Note

- You cannot perform the exposure compensation in the following shooting modes:
 - [Intelligent Auto]
 - [Superior Auto]
 - [Scene Selection]
- When using [Manual Exposure], you can perform the exposure compensation only when [ISO] is set to [ISO AUTO].

- Only a value between -3.0 EV and +3.0 EV with the equivalent image brightness appears on the screen when shooting. If you set an exposure compensation value outside this range, the image brightness on the screen will not be affected, but the value will be reflected in the recorded image.
- You can adjust the exposure compensation value within the range of -2.0 EV to +2.0 EV for movies.
- If you shoot a subject in extremely bright or dark conditions, or when you use the flash, you may not be able to get a satisfactory effect.

Related Topic

- [Exposure step](#)
- [Exp.comp.set](#)
- [Cont. Bracket](#)
- [Single Bracket](#)
- [Zebra Setting](#)

Interchangeable Lens Digital Camera
ILCE-6100 α6100

Dial/Wheel Ev Comp

You can adjust the exposure compensation using the control dial or the control wheel.

1 MENU →  2 (Camera Settings2) → [Dial/Wheel Ev Comp] → desired setting.

Menu item details

Off:

Does not assign the exposure compensation function to the control dial or control wheel.

Wheel:

Assigns the exposure compensation function to the control wheel.

Dial:

Assigns the exposure compensation function to the control dial.

Note

- If you assign the exposure compensation function to the control dial, the function that was originally assigned can be managed using the control wheel, and vice versa.
- When the shooting mode is set to [Manual Exposure] and ISO is set to [ISO AUTO], [Dial/Wheel Ev Comp] is disabled.

Interchangeable Lens Digital Camera
ILCE-6100 α6100

Exposure Set. Guide

You can set whether to display a guide when you change the exposure.

1 MENU →  2 (Camera Settings2) → [Exposure Set. Guide] → desired setting.

Menu item details

Off:

Does not display the guide.

On:

Displays the guide.

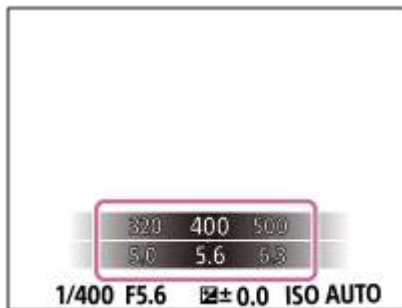

Interchangeable Lens Digital Camera
ILCE-6100 α6100

Exposure step

You can adjust the setting increment for the shutter speed, aperture, and exposure compensation values.

1 MENU →  1 (Camera Settings1) → [Exposure step] → desired setting.

Menu item details

0.3EV / 0.5EV

Metering Mode

Selects the metering mode that sets which part of the screen to measure for determining the exposure.

1 MENU →  1 (Camera Settings1) → [Metering Mode] → desired setting.

Menu item details

Multi:

Measures light on each area after dividing the total area into multiple areas and determines the proper exposure of the entire screen (Multi-pattern metering).

Center:

Measures the average brightness of the entire screen, while emphasizing the central area of the screen (Center-weighted metering).

Spot:

Measures only the central area (Spot metering). This mode is suitable for measuring light on the back-lit subject or when the contrast of the background and the subject is strong.

Hint

- When [Multi] is selected and [Face Priority in Multi Metering] is set to [On], the camera measures brightness based on detected faces.

Note

- [Metering Mode] is locked to [Multi] in the following shooting modes:
 - [Intelligent Auto]
 - [Superior Auto]
 - [Scene Selection]
 - Other zoom functions than the optical zoom

Related Topic

- [AE lock](#)
- [Face Priority in Multi Metering](#)
- [D-Range Optimizer \(DRO\)](#)
- [Auto HDR](#)

Face Priority in Multi Metering

Sets whether the camera measures brightness based on detected faces when [Metering Mode] is set to [Multi].

1 MENU →  1 (Camera Settings1) → [Face Priority in Multi Metering] → desired setting.

Menu item details

On:

The camera measures brightness based on detected faces.

Off:

The camera measures brightness using the [Multi] setting, without detecting faces.

Note

- When the shooting mode is set to [Intelligent Auto] or [Superior Auto], [Face Priority in Multi Metering] is locked to [On].
- When [Face/Eye Priority in AF] is set to [On] and [Subject Detection] is set to [Animal] under [Face/Eye AF Set.], [Face Priority in Multi Metering] does not work.

Related Topic

- [Metering Mode](#)

AE lock

When the contrast between the subject and background is high, such as when shooting a backlit subject or a subject near a window, meter the light at a spot where the subject appears to have the appropriate brightness and lock the exposure before shooting. To reduce the brightness of the subject, meter the light at a spot brighter than the subject and lock the exposure of the entire screen. To make the subject brighter, meter the light at a spot darker than the subject and lock the exposure of the entire screen.

1 Adjust the focus on the spot at which the exposure is adjusted.

2 Press the AEL button.



The exposure is locked, and ***** (AE lock) is displayed.

3 Keep pressing the AEL button and focus on the subject again, then shoot the picture.

- Keep holding the AEL button down while taking a shot if you want to continue shooting with the fixed exposure. Release the button to reset the exposure.

Hint

- If you select the MENU → 2 (Camera Settings2) → [Custom Key] or [Custom Key] → [AEL Button] → [AEL toggle], you can lock the exposure without holding down the button.



Note

- [AEL hold] and [AEL toggle] are not available when using zoom functions other than optical zoom.

Interchangeable Lens Digital Camera
ILCE-6100 α6100

AEL w/ shutter (still image)

Sets whether to fix the exposure when you press the shutter button halfway down.
Select [Off] to adjust the focus and the exposure separately.

1 MENU →  1 (Camera Settings1) → [ AEL w/ shutter] → desired setting.

Menu item details

Auto:

Fixes the exposure after adjusting the focus automatically when you press the shutter button halfway down when [Focus Mode] is set to [Single-shot AF]. When [Focus Mode] is set to [Automatic AF], and the product determines that the subject is moving, or you shoot burst images, the fixed exposure is cancelled.

On:

Fixes the exposure when you press the shutter button halfway down.

Off:

Does not fix the exposure when you press the shutter button halfway down. Use this mode when you want to adjust focus and exposure separately.

The product keeps adjusting the exposure while shooting in [Cont. Shooting] mode.

Note

- Operation using the AEL button is prioritized over the [ AEL w/ shutter] settings.

Interchangeable Lens Digital Camera
ILCE-6100 α6100

Exp.comp.set

Sets whether to apply the exposure compensation value to control both flash light and ambient light, or just ambient light.

① MENU →  1 (Camera Settings1) → [Exp.comp.set] → desired setting.

Menu item details

Ambient&flash:

Applies the exposure compensation value to control both flash light and ambient light.

Ambient only:

Applies the exposure compensation value to control ambient light only.

Related Topic

- [Flash Comp.](#)

Zebra Setting

Sets a zebra pattern, which appears over part of an image if the brightness level of that part meets the IRE level that you have set. Use this zebra pattern as a guide to adjust the brightness.

① MENU →  2 (Camera Settings2) → [Zebra Setting] → desired setting.

Menu item details

Zebra Display:

Sets whether to display the zebra pattern.

Zebra Level:

Adjusts the brightness level of the zebra pattern.

Hint

- You can register values to check the correct exposure or overexposure as well as the brightness level for [Zebra Level]. The settings for correct exposure confirmation and overexposure confirmation are registered to [Custom1] and [Custom2] respectively in the default settings.
- To check the correct exposure, set a standard value and the range for the brightness level. The zebra pattern will appear on areas that fall within the range you set.
- To check the overexposure, set a minimum value for the brightness level. The zebra pattern will appear over areas with a brightness level equal to or higher than the value you set.

Note

- The zebra pattern is not displayed on devices connected via HDMI.

Interchangeable Lens Digital Camera
ILCE-6100 α6100

D-Range Optimizer (DRO)

By dividing the image into small areas, the product analyzes the contrast of light and shadow between the subject and the background, and creates an image with the optimal brightness and gradation.

1 MENU →  1 (Camera Settings1) → [DRO/Auto HDR] → [D-Range Optimizer].

2 Select the desired setting using the left/right sides of the control wheel.

Menu item details

D-Range Optimizer: Auto:

Corrects the brightness automatically.

D-Range Optimizer: Lv1 — D-Range Optimizer: Lv5:

Optimizes the gradation of a recorded image for each divided area. Select the optimization level from Lv1 (weak) to Lv5 (strong).

Note

- In the following situations, [DRO/Auto HDR] is fixed to [Off]:
 - The shooting mode is set to [Sweep Panorama].
 - Multi Frame NR
 - When [Picture Effect] is set to other than [Off]
- [DRO/Auto HDR] is fixed to [Off] when the following modes are selected in [Scene Selection].
 - [Sunset]
 - [Night Scene]
 - [Night Portrait]
 - [Hand-held Twilight]
 - [Anti Motion Blur]

The setting is fixed to [D-Range Optimizer: Auto] when [Scene Selection] modes other than the above modes are selected.

- When shooting with [D-Range Optimizer], the image may be noisy. Select the proper level by checking the recorded image, especially when you enhance the effect.

Interchangeable Lens Digital Camera
ILCE-6100 α6100

Auto HDR

Shoots three images using different exposures and combines the images with correct exposure, the bright parts of an underexposed image, and the dark parts of an overexposed image to create images with a greater range of gradation (High Dynamic Range). One image with proper exposure and one overlaid image are recorded.

1 MENU →  1 (Camera Settings1) → [DRO/Auto HDR] → [Auto HDR].

2 Select the desired setting using the left/right sides of the control wheel.

Menu item details

 **Auto HDR: Exposure Diff. Auto:**

Corrects the brightness automatically.

 **Auto HDR: Exposure Diff. 1.0EV — Auto HDR: Exposure Diff. 6.0EV:**



Sets the exposure difference, based on the contrast of the subject. Select the optimization level from 1.0EV (weak) to 6.0EV (strong).

For example, if you set the exposure value to 2.0 EV, three images will be composed with the following exposure levels: -1.0 EV, correct exposure and +1.0 EV.

Hint

- The shutter is released three times for one shot. Be careful about the following:
 - Use this function when the subject is motionless or does not flash light.
 - Do not change the composition before shooting.

Note

- This function is not available when the [ File Format] is [RAW] or [RAW & JPEG].
- [Auto HDR] is not available in the following shooting modes:
 - [Intelligent Auto]
 - [Superior Auto]
 - [Sweep Panorama]
 - [Scene Selection]
- [Auto HDR] is not available in the following situations:
 - When [Multi Frame NR] is selected.
 - When [Picture Effect] is set to other than [Off].
- You cannot start the next shot until the capture process is completed after you shoot.
- You may not obtain the desired effect depending on the luminance difference of a subject and the shooting conditions.
- When the flash is used, this function has little effect.
- When the contrast of the scene is low or when product shake or subject blur occurs, you may not obtain good HDR images.  will be displayed over the recorded image to inform you when the camera detects image blurring. Change the composition or re-shoot the image carefully to avoid image blur, as needed.

Interchangeable Lens Digital Camera
ILCE-6100 α6100

ISO

Sensitivity to light is expressed by the ISO number (recommended exposure index). The larger the number, the higher the sensitivity.

1 ISO (ISO) on the control wheel → select desired setting.

- You can also select MENU →  1 (Camera Settings1) → [ISO].
- You can change the value by 1/3 EV steps by turning the control wheel. You can change the value by 1 EV steps by turning the control dial.

Menu item details

Multi Frame NR:

Combines continuous shots to create an image with less noise. Press the right side to display the setting screen, then select a desired value using the top/bottom sides of the control wheel.

Select the desired ISO number from ISO AUTO or ISO 100 – ISO 51200.

ISO AUTO:

Sets the ISO sensitivity automatically.

ISO 100 – ISO 51200:

Sets the ISO sensitivity manually. Selecting a larger number increases the ISO sensitivity.

Hint

- You can change the range of ISO sensitivity that is set automatically in [ISO AUTO] mode. Select [ISO AUTO] and press the right side of the control wheel, and set the desired values for [ISO AUTO Maximum] and [ISO AUTO Minimum]. The values are also applied when shooting in [ISO AUTO] mode under [Multi Frame NR].
- You can set the effect level for noise reduction by selecting [NR Effect] under [Multi Frame NR].

Note

- When [ File Format] is set to [RAW] or [RAW & JPEG], [Multi Frame NR] cannot be selected.
- When [Multi Frame NR] is selected, the flash, [D-Range Optimizer], or [Auto HDR] cannot be used.
- When [Picture Effect] is set to other than [Off], [Multi Frame NR] cannot be selected.
- [ISO AUTO] is selected when using the following functions:
 - [Intelligent Auto]
 - [Superior Auto]
 - [Scene Selection]
 - [Sweep Panorama]
- The higher the ISO value, the more noise will appear on the images.
- The available ISO settings will differ depending on whether you are shooting still images, shooting movies, or shooting slow-motion/quick-motion movies.
- When shooting movies, ISO values between 100 and 32000 are available. If the ISO value is set to a value larger than 32000, the setting is automatically switched to 32000. When you finish recording the movie, the ISO value returns to the original setting.
- When you use [Multi Frame NR], it takes some time for the product to perform the overlay processing of images.

- When you select [ISO AUTO] with the shooting mode set to [P], [A], [S] or [M], the ISO sensitivity will be automatically adjusted within the set range.

Interchangeable Lens Digital Camera
ILCE-6100 α6100

The zoom features available with this product

The zoom feature of the product provides a higher magnification zoom by combining various zoom features. The icon displayed on the screen changes, according to the selected zoom feature.

When a power zoom lens is mounted:

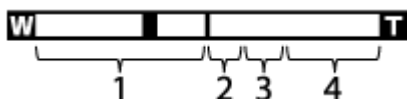

When a lens other than a power zoom lens is mounted:



1. Optical zoom range

Zoom images in the zoom range of a lens.

When a power zoom lens is mounted, the zoom bar of the optical zoom range is displayed.

When a lens other than a power zoom lens is mounted, the zoom slider is fixed at the left end of the zoom bar while the zoom position is in the optical zoom range (displayed as $\times 1.0$).

2. Smart Zoom range ()

Zoom images without causing the original quality to deteriorate by partially cropping an image (only when [ JPEG Image Size] is set to [M] or [S]).





3. Clear Image Zoom range ()



Zoom images using an image process with less deterioration. When you set [Zoom Setting] to [On:ClearImage Zoom] or [On:Digital Zoom], you can use this zoom function.

4. Digital Zoom range ()

You can magnify images using an image process. When you set [Zoom Setting] to [On:Digital Zoom], you can use this zoom function.

Note

- The default setting for the [Zoom Setting] is [Optical zoom only].
- The default setting for the [ JPEG Image Size] is [L]. To use the smart zoom, change [ JPEG Image Size] to [M] or [S].
- The Smart Zoom, Clear Image Zoom and Digital Zoom functions are not available when shooting in the following situations:
 - The shooting mode is set to [Sweep Panorama].
 - [ File Format] is set to [RAW] or [RAW & JPEG].
 - [ Record Setting] is set to [120p]/[100p].
 - During slow-motion/quick-motion shooting with the [ S&Q Frame Rate] set to [120fps]/[100fps]
- You cannot use the Smart Zoom function with movies.
- When a power zoom lens is mounted, you cannot use [Zoom] under MENU. If you enlarge image past the optical zoom range, the product automatically switches to another [Zoom] function than the optical zoom.
- When you use a zoom function other than the optical zoom, the [Focus Area] setting is disabled and the focusing frame is shown by the dotted line. The AF operates with priority on and around the center area.
- When you use the Smart Zoom, Clear Image Zoom or Digital Zoom function, [Metering Mode] is locked to [Multi].



- When using the Smart Zoom, Clear Image Zoom or Digital Zoom function, the following functions are not available:
 - Face/Eye Priority in AF
 - Face Priority in Multi Metering
 - Tracking function
 -  Auto Object Framing
- To use another zoom function than the optical zoom for movies, assign [Zoom] to the desired key using [ Custom Key].

Related Topic



- [Clear Image Zoom/Digital Zoom \(Zoom\)](#)
- [Zoom Setting](#)
- [About zoom scale](#)
- [Focus Area](#)

Clear Image Zoom/Digital Zoom (Zoom)

When you use a zoom function other than the optical zoom, you can exceed the zoom range of the optical zoom.

- 1 **MENU** →  (Camera Settings2) → [Zoom Setting] → [On:ClearImage Zoom] or [On:Digital Zoom].
- 2 **When a power zoom lens is mounted, move the zoom lever or the zoom ring of the zoom lens to enlarge subjects.**
 - When you exceed the zoom range of the optical zoom, the camera automatically switches to another zoom than the optical zoom.
- 3 **When a lens other than a power zoom lens is mounted, select MENU** →  (Camera Settings2) → [Zoom] → **desired value.**

Press the center of the control wheel to exit.

 - You can also assign the [Zoom] function to the desired button by selecting MENU →  (Camera Settings2) → [ Custom Key] or [ Custom Key].

Related Topic

- [Zoom Setting](#)
- [The zoom features available with this product](#)
- [Assigning frequently used functions to buttons \(Custom Key\)](#)

Interchangeable Lens Digital Camera
ILCE-6100 α6100

Zoom Setting

You can select the zoom setting of the product.

1 MENU →  2 (Camera Settings2) → [Zoom Setting] → desired setting.

Menu item details

Optical zoom only:

Limits the zoom range to the optical zoom. You can use the Smart Zoom function if you set [ JPEG Image Size] to [M] or [S].

On:ClearImage Zoom :

Select this setting to use Clear Image Zoom. Even if the zoom range exceeds the optical zoom, the product magnifies images using an image process with less deterioration.

On:Digital Zoom :

When the zoom range of the Clear Image Zoom is exceeded, the product magnifies images to the largest scale. However, the image quality will deteriorate.

Note

- Set [Optical zoom only] if you want to magnify images within the range in which image quality does not deteriorate.

Related Topic

- [The zoom features available with this product](#)
- [About zoom scale](#)

Interchangeable Lens Digital Camera
ILCE-6100 α6100

About zoom scale

The zoom scale that is used in combination with the zoom of the lens changes according to the selected image size.

When [ Aspect Ratio] is [3:2]

 JPEG Image Size	Zoom Setting		
	Optical zoom only (smart zoom)	On:ClearImage Zoom	On:Digital Zoom
L: 24M	-	Approx. 2×	Approx. 4×
M: 12M	Approx. 1.4×	Approx. 2.8×	Approx. 5.7×
S: 6.0M	Approx. 2×	Approx. 4×	Approx. 8×

Related Topic













- [Clear Image Zoom/Digital Zoom \(Zoom\)](#)
- [The zoom features available with this product](#)
- [Zoom Setting](#)
- [JPEG Image Size \(still image\)](#)

White Balance

Corrects the tone effect of the ambient light condition to record a neutral white subject in white. Use this function when the color tones of the image did not come out as you expected, or when you want to change the color tones on purpose for photographic expression.

1 MENU →  1 (Camera Settings1) → [White Balance] → desired setting.

Menu item details

AWB   Auto /  Daylight /  Shade /  Cloudy /  Incandescent /  -1 Fluor.: Warm White /  0 Fluor.: Cool White /  +1 Fluor.: Day White /  +2 Fluor.: Daylight /  Flash /  Underwater Auto :

When you select a light source that illuminates the subject, the product adjusts the color tones to suit to the selected light source (preset white balance). When you select [Auto], the product automatically detects the light source and adjusts the color tones.



C.Temp./Filter:

Adjusts the color tones depending on the light source. Achieves the effect of CC (Color Compensation) filters for photography.

Custom 1/Custom 2/Custom 3:

Memorizes the basic white color under the light conditions for the shooting environment.

Hint

- You can display the fine adjustment screen and perform fine adjustments of the color tones as required by pressing the right side of the control wheel. When [C.Temp./Filter] is selected, you can change the color temperature by turning the control dial instead of pressing the right side of the control wheel.
- If the color tones do not come out as you expected in the selected settings, perform [WB bracket] shooting.
-  or  is displayed only when [Priority Set in AWB] is set to [Ambience] or [White].

Note

- [White Balance] is fixed to [Auto] in the following shooting modes:
 - [Intelligent Auto]
 - [Superior Auto]
 - [Scene Selection]
- If you use a mercury lamp or a sodium lamp as a light source, the accurate white balance will not be obtained because of the characteristics of the light. It is recommended to shoot images using a flash or select [Custom 1] to [Custom 3].

Related Topic

- [Capturing a standard white color to set the white balance \(custom white balance\)](#)
- [Priority Set in AWB](#)
- [WB bracket](#)

Interchangeable Lens Digital Camera
ILCE-6100 α6100

Priority Set in AWB

Selects which tone to prioritize when shooting under lighting conditions such as incandescent light when [White Balance] is set to [Auto].

① MENU →  1 (Camera Settings1) → [Priority Set in AWB] → desired setting.

Menu item details

AWB
STD **Standard:**

Shoots with standard auto white balance. The camera automatically adjusts the color tones.

AWB
Ambi **Ambience:**

Prioritizes the color tone of the light source. This is suitable when you want to produce a warm atmosphere.

AWB
White **White:**

Prioritizes a reproduction of white color when the color temperature of the light source is low.

Related Topic

- [White Balance](#)

Interchangeable Lens Digital Camera
ILCE-6100 α6100

Capturing a standard white color to set the white balance (custom white balance)

In a scene where the ambient light consists of multiple types of light sources, it is recommended to use the custom white balance in order to accurately reproduce the whiteness. You can register 3 settings.

1 MENU →  1 (Camera Settings1) → [White Balance] → Select from among [Custom 1] to [Custom 3], and then press the right side of the control wheel.

2 Select  SET, and then press the center of the control wheel.

3 Hold the product so that the white area fully covers the white-balance capture frame, and then press the center of the control wheel.

After the shutter sound beeps, the calibrated values (Color Temperature and Color Filter) are displayed.

- After capturing a standard white color, you can display the fine adjustment screen by pressing the right side of the control wheel. You can finely adjust the color tones as needed.

4 Press the center of the control wheel.

The calibrated values will be registered. The monitor will return to the recording information display while retaining the registered custom white-balance setting.

- The registered custom white balance setting will remain memorized until overwritten by the another setting.





Note

- The message [Capturing of the custom WB failed.] indicates that the value is in the unexpected range, for example when the subject is too vivid. You can register the setting at this point, but it is recommended that you set the white balance again. When an error value is set, the indicator  turns orange on the recording information display. The indicator will be displayed in white when the set value is in the expected range.
- If you use a flash when capturing a basic white color, the custom white balance will be registered with the lighting from the flash. Be sure to use a flash whenever you shoot with recalled settings that were registered with a flash.

Interchangeable Lens Digital Camera
ILCE-6100 α6100

Creative Style

Allows you to set the desired image processing and finely adjust contrast, saturation and sharpness for each image style. You can adjust exposure (shutter speed and aperture) as you like with this function, unlike with [Scene Selection], where the product adjusts the exposure.

- 1 MENU →  1 (Camera Settings1) → [Creative Style].
- 2 Select the desired style using the top/bottom sides of the control wheel.
- 3 To adjust  (Contrast),  (Saturation) and  (Sharpness), select the desired item using the right/left sides, and then select the value using the top/bottom sides.

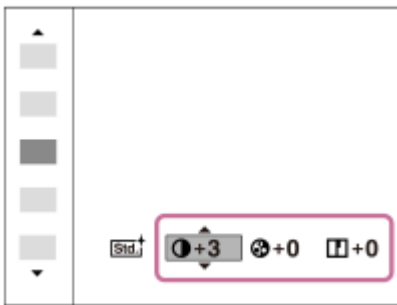

Menu item details

Standard:

For shooting various scenes with rich gradation and beautiful colors.

Vivid:

The saturation and contrast are heightened for shooting striking images of colorful scenes and subjects such as flowers, spring greenery, blue sky, or ocean views.

Portrait:

For capturing skin in a soft tone, ideally suited for shooting portraits.

Landscape:

The saturation, contrast, and sharpness are heightened for shooting vivid and crisp scenery. Distant landscapes also stand out more.

Sunset:

For shooting the beautiful red of the setting sun.

Black & White:

For shooting images in black and white monotone.

Sepia:

For shooting images in sepia monotone.

To set [Contrast], [Saturation] and [Sharpness]

[Contrast], [Saturation], and [Sharpness] can be adjusted for each image style preset such as [Standard] and [Landscape].

Select an item to be set by pressing the right/left sides of the control wheel, then set the value using the top/bottom sides of the control wheel.

Contrast:

The higher the value selected, the more the difference of light and shadow is accentuated, and the bigger the effect on the image.

Saturation:

The higher the value selected, the more vivid the color. When a lower value is selected, the color of the image is restrained and subdued.

Sharpness:

Adjusts the sharpness. The higher the value selected, the more the contours are accentuated, and the lower the value selected, the more the contours are softened.

Note

- [Creative Style] is fixed to [Standard] in the following situations:
 - [Intelligent Auto]
 - [Superior Auto]
 - [Scene Selection]
 - [Picture Effect] is set to other than [Off].

- When this function is set to [Black & White] or [Sepia], [Saturation] cannot be adjusted.

Interchangeable Lens Digital Camera
ILCE-6100 α6100

Picture Effect

Select the desired effect filter to achieve more impressive and artistic images.

1 MENU →  1 (Camera Settings1) → [Picture Effect] → desired setting.

Menu item details

 **Off:**

Disables the [Picture Effect] function.

 **Toy Camera:**

Creates a soft image with shaded corners and reduced sharpness.

 **Pop Color:**

Creates a vivid look by emphasizing color tones.

 **Posterization:**

Creates a high contrast, abstract look by heavily emphasizing primary colors, or in black and white.

 **Retro Photo:**

Creates the look of an aged photo with sepia color tones and faded contrast.

 **Soft High-key:**

Creates an image with the indicated atmosphere: bright, transparent, ethereal, tender, soft.

 **Partial Color:**

Creates an image which retains a specific color, but converts others to black and white.

 **High Contrast Mono.:**

Creates a high-contrast image in black and white.

 **Soft Focus:**

Creates an image filled with a soft lighting effect.

 **HDR Painting:**

Creates the look of a painting, enhancing the colors and details.

 **Rich-tone Mono.:**

Creates an image in black and white with rich gradation and reproduction of details.

 **Miniature:**

Creates an image which enhances the subject vividly, with the background defocused considerably. This effect may often be found in pictures of miniature models.

 **Watercolor:**

Creates an image with ink bleed and blurring effects as if painted using watercolors.

 **Illustration:**

Creates an illustration-like image by emphasizing the outlines.

Hint

- You can perform detailed settings for some items using the left/right sides of the control wheel.

Note

- When you use a zoom function other than the optical zoom, setting the zoom scale larger makes [Toy Camera] less effective.
- When [Partial Color] is selected, images may not retain the selected color, depending on the subject or shooting conditions.
- You cannot check the following effects on the shooting screen, because the product processes the image after the shot. Also, you cannot shoot another image until image processing is finished. You cannot use these effects with movies.

- [Soft Focus]
 - [HDR Painting]
 - [Rich-tone Mono.]
 - [Miniature]
 - [Watercolor]
 - [Illustration]
- In the case of [HDR Painting] and [Rich-tone Mono.], the shutter is released three times for one shot. Be careful about the following:
 - Use this function when the subject is motionless or does not flash light.
 - Do not change the composition during shooting.



When the contrast of the scene is low or when significant camera-shake or subject blur has occurred, you may not be able to obtain good HDR images. If the product detects such a situation,  appear on the recorded image to inform you of this situation. Change the composition or re-shoot the image carefully to avoid image blur, as needed.

- This function is not available in the following shooting modes:
 - [Intelligent Auto]
 - [Superior Auto]
 - [Scene Selection]
 - [Sweep Panorama]
- When [ File Format] is set to [RAW] or [RAW & JPEG], this function is not available.

Interchangeable Lens Digital Camera
ILCE-6100 α6100

Soft Skin Effect (still image)

Sets the effect used for shooting the skin smoothly in the Face Detection function.

1 MENU →  1 (Camera Settings1) → [ Soft Skin Effect] → desired setting.

Menu item details

 Off:

Does not use the [ Soft Skin Effect] function.





 On:

Uses the [ Soft Skin Effect].

Hint

- When [ Soft Skin Effect] is set to [On], you can select the effect level. Select the effect level by pressing the right/left side of the control wheel.

Note

- [ Soft Skin Effect] is not available when [ File Format] is [RAW].
- [ Soft Skin Effect] is not available for RAW images when the [ File Format] is [RAW & JPEG].

Auto Object Framing (still image)

When this product detects and shoots faces, macro shooting subjects or subjects that are tracked by [Tracking], the product automatically trims the image into an appropriate composition, and then saves it. Both the original and the trimmed images are saved. The trimmed image is recorded in the same size as the original image size.

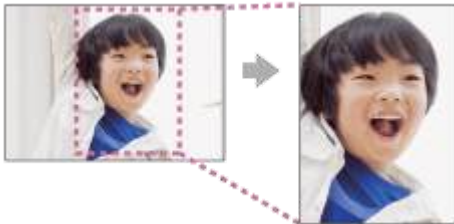

1 MENU → 1 (Camera Settings1) → Auto Object Framing → desired setting.

Menu item details

Off:

Does not trim images.

Auto:

Automatically trims images into an appropriate composition.



Note

- The trimmed image may not be the best possible composition, depending on the shooting conditions.
- Auto Object Framing cannot be set when File Format is set to [RAW] or [RAW & JPEG].
- Auto Object Framing is not available in the following situations.
 - The shooting mode is set to [Sweep Panorama]
 - The shooting mode is set to [Movie]
 - The shooting mode is set to [S&Q Motion]
 - The shooting mode is set to [Hand-held Twilight], [Sports Action], [Anti Motion Blur] in [Scene Selection]
 - [Drive Mode] is set to [Cont. Shooting], [Self-timer(Cont)], [Cont. Bracket], [Single Bracket], [WB bracket], or [DRO Bracket].
 - The ISO sensitivity is set to [Multi Frame NR].
 - [DRO/Auto HDR] is set to [Auto HDR].
 - Other zoom functions than the optical zoom
 - When shooting in Manual Focus mode
 - [Picture Effect] is set to [Soft Focus], [HDR Painting], [Rich-tone Mono.], [Miniature], [Watercolor], or [Illustration].

Interchangeable Lens Digital Camera
ILCE-6100 α6100

Color Space (still image)

The way colors are represented using combinations of numbers or the range of color reproduction is called “color space.” You can change the color space depending on the purpose of the image.

① MENU →  1 (Camera Settings1) → [ Color Space] → desired setting.

Menu item details

sRGB:

This is the standard color space of the digital camera. Use [sRGB] in normal shooting, such as when you intend to print out the images without any modification.

AdobeRGB:

This color space has a wide range of color reproduction. When a large part of the subject is vivid green or red, Adobe RGB is effective. The file name of the recorded image starts with “_.”

Note

- [AdobeRGB] is for applications or printers that support color management and DCF2.0 option color space. Images may not be printed or viewed in the correct colors if you use applications or printers that do not support Adobe RGB.
- When displaying images that were recorded with [AdobeRGB] on non-Adobe RGB-compliant devices, the images will be displayed with low saturation.

Interchangeable Lens Digital Camera
ILCE-6100 α6100

Release w/o Lens

Sets whether or not the shutter can be released when no lens is attached.

1 MENU →  2 (Camera Settings2) → [Release w/o Lens] → desired setting.

Menu item details

Enable:

Releases the shutter when no lens is attached. Select [Enable] when attaching the product to an astronomical telescope, etc.

Disable:

Does not release the shutter when a lens is not attached.

Note

- Correct metering cannot be achieved when you use lenses that do not provide a lens contact, such as the lens of an astronomical telescope. In such cases, adjust the exposure manually by checking it on the recorded image.

Interchangeable Lens Digital Camera
ILCE-6100 α6100

Release w/o Card

Sets whether the shutter can be released when no memory card has been inserted.

1 MENU →  2 (Camera Settings2) → [Release w/o Card] → desired setting.

Menu item details

Enable:

Releases the shutter even if no memory card has been inserted.

Disable:



Does not release the shutter when no memory card has been inserted.

Note

- When no memory card has been inserted, the images shot will not be saved.
- The default setting is [Enable]. It is recommended that you select [Disable] prior to actual shooting.

Silent Shooting (still image)

You can shoot images without the shutter sound.

① MENU →  2 (Camera Settings2) → [ Silent Shooting] → desired setting.

Menu item details









On:

You can shoot images without the shutter sound.

Off:

[ Silent Shooting] is deactivated.

Note

- Use the [ Silent Shooting] function on your own responsibility, while taking sufficient consideration to the privacy and portrait rights of the subject.
- Even if [ Silent Shooting] is set to [On], it will not be completely silent.
- Even if [ Silent Shooting] is set to [On], the operating sound of the aperture and focus will sound.
- When shooting still images using the [ Silent Shooting] function with low ISO sensitivity, if you point the camera at a very bright light source, high intensity areas on the monitor may be recorded in darker tones.
- When the power is turned off, the shutter sound may beep in rare occasions. This is not a malfunction.
- Image distortion caused by the movement of the subject or the camera may occur.
- If you shoot images under instantaneous lightning or flickering lights, such as the flash light from other cameras or fluorescent lighting, a striping effect may occur on the image.
- If you want to turn off the beep that sounds when the subject is in focus or the self-timer operates, set [Audio signals] to [Off].
- Even if [ Silent Shooting] is set to [On], you may hear the shutter sound under the following circumstances:
 - When you capture a standard white color for the custom white balance
 - When you register faces using [Face Registration]
- You cannot select [ Silent Shooting] when the mode dial is set to other than P/A/S/M.
- When [ Silent Shooting] is set to [On], the following functions are not available:
 - Flash shooting
 - Auto HDR
 - Picture Effect
 -  Long Exposure NR
 - e-Front Curtain Shutter
 - Superior Auto Img. Extract.
 - BULB shooting
 - Multi Frame NR
- After you turn the camera on, the time in which you can start recording is extended by approximately 0.5 seconds.

Interchangeable Lens Digital Camera
ILCE-6100 α6100

e-Front Curtain Shutter

The electronic front curtain shutter function shortens the time lag between when the shutter button is pressed and the shutter is released.

① MENU →  (Camera Settings2) → [e-Front Curtain Shutter] → desired setting.

Menu item details

On:

Uses the electronic front curtain shutter function.

Off:

Does not use the electronic front curtain shutter function.

Note

- When you shoot at high shutter speeds with a large-aperture lens attached, out-of-focus circle produced by the bokeh effect may get cut off because of the shutter mechanism. If this happens, set [e-Front Curtain Shutter] to [Off].
- When a lens made by another manufacturer (including a Minolta/Konica-Minolta lens) is used, set this function to [Off]. If you set this function to [On], the correct exposure will not be set or the image brightness will be uneven.
- When you shoot at high shutter speeds, the image brightness may become uneven depending on the shooting environment. In such cases, set [e-Front Curtain Shutter] to [Off].

Interchangeable Lens Digital Camera
ILCE-6100 α6100

SteadyShot

Sets whether or not to use the SteadyShot function.

1 MENU →  2 (Camera Settings2) → [SteadyShot] → desired setting.

Menu item details

On:

Uses [SteadyShot].

Off:

Does not use [SteadyShot].

We recommend that you set [Off] when using a tripod, etc.

Note

- You cannot set the SteadyShot function when you are using an A-mount lens (sold separately), or when the name of the attached lens does not contain the letters "OSS," such as "E16mm F2.8."

Interchangeable Lens Digital Camera
ILCE-6100 α6100

Lens Comp.

Compensates for shading in the corners of the screen or distortion of the screen, or reduces color deviation at the corners of the screen caused by certain lens characteristics.

① MENU →  1 (Camera Settings1) → [Lens Comp.] → desired setting.

Menu item details

Shading Comp.:

Sets whether to automatically compensate for darkness in the corners of the screen. ([Auto]/[Off])

Chromatic Aberration Comp.:

Sets whether to automatically reduce color deviation at the corners of the screen. ([Auto]/[Off])

Distortion Comp.:



Sets whether to automatically compensate for distortion of the screen. ([Auto]/[Off])

Note

- This function is only available when using an automatic compensation compliant lens.
- Darkness in the corners of the screen may not be corrected with [Shading Comp.], depending on the lens type.
- Depending on the attached lens, [Distortion Comp.] is fixed to [Auto], and you cannot select [Off].

Long Exposure NR (still image)

When you set the shutter speed to 1 second(s) or longer (long exposure shooting), noise reduction is turned on for the duration that the shutter is open. With the function turned on, the grainy noise typical of long exposures is reduced.

① MENU →  1 (Camera Settings1) → [ Long Exposure NR] → desired setting.

Menu item details



On:

Activates noise reduction for the same duration that the shutter is open. When noise reduction is in progress, a message appears and you cannot take another picture. Select this to prioritize the image quality.

Off:

Does not activate noise reduction. Select this to prioritize the timing of shooting.



Note

- Noise reduction may not be activated even if [ Long Exposure NR] is set to [On] in the following situations:
 - The shooting mode is set to [Sweep Panorama].
 - [Drive Mode] is set to [Cont. Shooting] or [Cont. Bracket].
 - The shooting mode is set to [Scene Selection] and [Sports Action], [Hand-held Twilight] or [Anti Motion Blur] is selected.
 - The ISO sensitivity is set to [Multi Frame NR].
- [ Long Exposure NR] cannot be set to [Off] in the following shooting modes:
 - [Intelligent Auto]
 - [Superior Auto]
 - [Scene Selection]

Interchangeable Lens Digital Camera
ILCE-6100 α6100

High ISO NR (still image)

When shooting with high ISO sensitivity, the product reduces noise that becomes more noticeable when the product sensitivity is high.

1 MENU →  1 (Camera Settings1) → [ High ISO NR] → desired setting.

Menu item details

Normal:

Activates high ISO noise reduction normally.





Low:

Activates high ISO noise reduction moderately.

Off:

Does not activate high ISO noise reduction. Select this to prioritize the timing of shooting.

Note

- [ High ISO NR] is fixed to [Normal] in the following shooting modes:
 - [Intelligent Auto]
 - [Superior Auto]
 - [Scene Selection]
 - [Sweep Panorama]
- When [ File Format] is set to [RAW], this function is not available.
- [ High ISO NR] does not work for RAW images when the [ File Format] is [RAW & JPEG].

Interchangeable Lens Digital Camera
ILCE-6100 α6100

Regist. Faces Priority

Sets whether to focus with higher priority on faces registered using [Face Registration].

1 MENU →  1 (Camera Settings1) → [Regist. Faces Priority] → desired setting.

Menu item details

On:

Focuses with higher priority on faces registered using [Face Registration].

Off:

Focuses without giving higher priority to registered faces.

Hint

- To use the [Regist. Faces Priority] function, set as follows.
 - [Face/Eye Priority in AF] under [Face/Eye AF Set.]: [On]
 - [Subject Detection] under [Face/Eye AF Set.]: [Human]

Related Topic

- [Face/Eye AF Set.](#)
- [Face Registration \(New Registration\)](#)
- [Face Registration \(Order Exchanging\)](#)

Smile Shutter

The camera automatically shoots an image when it detects a smiling face.

1 MENU →  1 (Camera Settings1) → [Smile Shutter] → desired setting.

Menu item details

Off:

Does not use the [Smile Shutter] function.

On:

The camera automatically shoots an image when it detects a smiling face. You can select [On: Slight Smile], [On: Normal Smile], or [On: Big Smile] for the sensitivity of detection.

Tips for capturing smiles more effectively

- Do not cover the eyes with front hair and keep the eyes narrowed.
- Do not obscure the face by a hat, masks, sunglasses, etc.
- Try to orient the face in front of the product and be as level as possible.
- Give a clear smile with an open mouth. The smile is easier to be detected when the teeth are shown.
- If you press the shutter button during Smile Shutter, the product shoots the image. After shooting, the product returns to Smile Shutter mode.

Note

- You cannot use the [Smile Shutter] function with the following functions:
 - [Sweep Panorama]
 - [Picture Effect]
 - When using the [Focus Magnifier] function.
 - [Scene Selection] is set to [Landscape], [Night Scene], [Sunset], [Hand-held Twilight] or [Anti Motion Blur].
 - When recording movies.
 - During slow-motion/quick-motion shooting.
- Up to 8 faces of your subjects can be detected.
- The product may not detect faces at all or may accidentally detect other objects as faces in some conditions.
- If the product cannot detect a smile, adjust the Smile Detection Sensitivity.
- If [Func. of Touch Operation] is set to [Touch Tracking] and you touch a face on the monitor to track while [Smile Shutter] is active, smile detection will only apply to that face.

Face Registration (New Registration)

If you register faces in advance, the product can focus on the registered face as a priority.

- 1 MENU →  1 (Camera Settings1) → [Face Registration] → [New Registration].
- 2 Align the guide frame with the face to be registered, and press the shutter button.
- 3 When a confirmation message appears, select [Enter].

Note

- Up to eight faces can be registered.
- Shoot the face from the front in a brightly lit place. The face may not be registered correctly if it is obscured by a hat, a mask, sunglasses, etc.

Related Topic

- [Regist. Faces Priority](#)
- [Smile Shutter](#)

Interchangeable Lens Digital Camera
ILCE-6100 α6100

Face Registration (Order Exchanging)

When multiple faces are registered to be given priority, the face registered first will be given priority. You can change the priority order.

- 1 MENU →  1 (Camera Settings1) → [Face Registration] → [Order Exchanging].
 - 2 Select a face to change the order of priority.
 - 3 Select the destination.
-
-

Related Topic

- [Regist. Faces Priority](#)
- [Smile Shutter](#)

Interchangeable Lens Digital Camera
ILCE-6100 α6100

Face Registration (Delete)

Deletes a registered face.

1 MENU →  1 (Camera Settings1) → [Face Registration] → [Delete].

If you select [Delete All], you can delete all registered faces.

Note

- Even if you execute [Delete], the data for registered face will remain in the product. To delete the data for registered faces from the product, select [Delete All].

Using flash

In dark environments, use the flash to light up the subject while shooting. Also use the flash to prevent camera-shake.

1 Press the (Flash pop-up) button to pop up the flash.

- The flash does not pop up automatically.

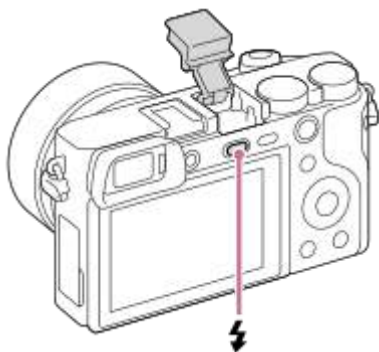

2 Press the shutter button fully down.

- The available flash modes depend on the shooting mode and function.

When you do not use the flash

When not using the flash, press it back into the camera body.

Note

- The light of the flash may be blocked if the lens hood is attached and the lower part of a recorded image may be shaded. Remove the lens hood.
- When using the flash, stand 1 m or more away from the subject.
- If you fire the flash before the flash unit pops up entirely, it may cause malfunction.
- You cannot use the flash when recording movies. (You can use an LED light when using a flash (sold separately) with an LED light.)
- When an external flash (sold separately) is attached to the Multi Interface Shoe, the state of the external flash has priority over the flash setting of this product. You cannot use the internal flash of this product.
- Before attaching/removing an accessory such as a flash to/from the Multi Interface Shoe, turn off the product first. When attaching an accessory, make sure that the accessory is fixed securely to the product.
- Do not use the Multi Interface Shoe with a commercially available flash that applies voltage of 250 V or more or has the reverse polarity of the camera. Doing so may cause a malfunction.
- When shooting with the flash and the zoom is set to W, the shadow of the lens may appear on the screen, depending on the shooting conditions. If this happens, shoot away from the subject or set the zoom to T and shoot with the flash again.
- The light of the flash may be blocked, depending on the lens.
- The corners of a recorded image may be shaded, depending on the lens.
- When the monitor is tilted upward 90 degrees or more, it is difficult to operate the  (Flash pop-up) button. Raise the flash unit before adjusting the monitor angle.

- When using flash to shoot pictures of yourself, be careful not to look directly at the light, because the flash will go off at a close distance. To prevent the flash from hitting the monitor when you press it back down into the camera body after use, first return the monitor to its original position.
- For details on compatible accessories for the Multi Interface Shoe, visit the Sony website, or consult your Sony dealer or local authorized Sony service facility.

Related Topic

- [Flash Mode](#)
- [Wireless Flash](#)

5-009-879-12(1) Copyright 2019 Sony Corporation

Interchangeable Lens Digital Camera
ILCE-6100 α6100

Red Eye Reduction

When using the flash, it is fired two or more times before shooting to reduce the red-eye phenomenon.

1 MENU →  1 (Camera Settings1) → [Red Eye Reduction] → desired setting.

Menu item details

On:

The flash is always fired to reduce the red-eye phenomenon.

Off:

Does not use Red Eye Reduction.

Note

- Red Eye Reduction may not produce the desired effects. It depends on individual differences and conditions, such as distance to the subject, or whether the subject looks at the pre-strobe or not.

Interchangeable Lens Digital Camera
ILCE-6100 α6100

Flash Mode

You can set the flash mode.

1 MENU →  1 (Camera Settings1) → [Flash Mode] → desired setting.

Menu item details

Flash Off:

The flash does not operate.

AUTO Autoflash:

The flash works in dark environments or when shooting towards bright light.

Fill-flash:

The flash works every time you trigger the shutter.

SLOW Slow Sync.:

The flash works every time you trigger the shutter. Slow sync shooting allows you to shoot a clear image of both the subject and the background by slowing the shutter speed.

REAR Rear Sync.:

The flash works right before the exposure is completed every time you trigger the shutter. Rear sync shooting allows you to shoot a natural image of the trail of a moving subject such as a moving car or a walking person.

Note

- The default setting depends on the shooting mode.
- Some [Flash Mode] settings are not available, depending on the shooting mode.

Related Topic

- [Using flash](#)
- [Wireless Flash](#)

Flash Comp.

Adjusts the amount of flash light in a range of -3.0 EV to $+3.0$ EV. Flash compensation changes the amount of flash light only. Exposure compensation changes the amount of flash light along with the change of the shutter speed and aperture.

1 MENU →  1 (Camera Settings1) → [Flash Comp.] → desired setting.

- Selecting higher values (+ side) makes the flash level higher, and lower values (- side) makes the flash level lower.

Note

- [Flash Comp.] does not work when the shooting mode is set to the following modes:
 - [Intelligent Auto]
 - [Superior Auto]
 - [Sweep Panorama]
 - [Scene Selection]
- The higher flash effect (+ side) may not be visible due to the limited amount of flash light available, if the subject is outside the maximum range of the flash. If the subject is very close, the lower flash effect (- side) may not be visible.
- If you attach an ND filter to the lens or attach a diffuser or a color filter to the flash, the appropriate exposure may not be achieved and images may turn out dark. In this case, adjust [Flash Comp.] to the desired value.

Related Topic



- [Using flash](#)

Interchangeable Lens Digital Camera
ILCE-6100 α6100

FEL lock

The flash level is automatically adjusted so that the subject gets the optimum exposure during normal flash shooting. You can also set the flash level in advance.

FEL: Flash Exposure Level

1 MENU →  (Camera Settings2) → [ Custom Key] → desired button, then assign the [FEL Lock toggle] function to the button.

2 Center the subject on which FEL is to be locked, and adjust the focus.



3 Press the button to which [FEL Lock toggle] is registered, and set the flash amount.

- A pre-flash flashes.
- The  (FEL lock) lights up.

4 Adjust the composition and shoot the image.



- When you want to release the FEL lock, press the button to which the [FEL Lock toggle] is registered again.

Hint

- By setting [FEL Lock hold], you can hold the setting while the button is pressed down. Also, by setting [FEL Lock/AEL hold] and [FEL Lock/AEL toggle], you can shoot images with the AE locked in the following situations.
 - When [Flash Mode] is set to [Flash Off] or [Autoflash].
 - When the flash cannot go off.

Note

- If a flash that does not support the FEL lock is attached, an error message is displayed.
- When both AE and FEL lock are fixed,  lights up.

Related Topic

- [Assigning frequently used functions to buttons \(Custom Key\)](#)

5-009-879-12(1) Copyright 2019 Sony Corporation

Wireless Flash

There are two methods for wireless flash shooting: light-signal flash shooting that uses the light of the flash attached to the camera as a signal light, and radio-signal flash shooting that uses wireless communication. To perform radio-signal flash shooting, use a compatible flash or the Wireless Radio Commander (sold separately). For details on how to set each method, refer to the instruction manual of the flash or the Wireless Radio Commander.

- 1 **MENU** →  1 (Camera Settings1) → **[Wireless Flash]** → **[On]**.
- 2 **Remove the shoe cap from the camera, and then attach the flash or the Wireless Radio Commander.**
 - When performing light-signal wireless flash shooting, set the attached flash as the controller.
When performing radio-signal wireless flash shooting with a flash attached to the camera, set the attached flash as the commander.
- 3 **Set up an off-camera flash that is set to wireless mode, or that is attached to the Wireless Radio Receiver (sold separately).**
 - Press the AEL button on the camera to perform a test flashing.

Menu item details

Off:

Does not use the wireless flash function.

On:

Uses the wireless flash function to make an external flash or flashes emit light at a distance from the camera.

Setting of the AEL button

We recommend that you set **MENU** →  2 (Camera Settings2) → [ Custom Key] → [AEL Button] to [AEL hold] when performing wireless flash shooting.

Note

- Wireless flash shooting cannot be performed with the camera's built-in flash.
- The off-camera flash may emit light after receiving a light signal from a flash used as the controller of another camera. If this occurs, change the channel of your flash. For details on how to change the channel, refer to the instruction manual for the flash.
- For the flash that is compatible with wireless flash shooting, visit the Sony website, or consult your Sony dealer or local authorized Sony service facility.

Interchangeable Lens Digital Camera
ILCE-6100 α6100

Shooting movies

You can record movies by pressing the MOVIE (Movie) button.

1 Press the MOVIE button to start recording.

- Since the [MOVIE Button] is set to [Always] in the default setting, movie recording can be started from any shooting mode.

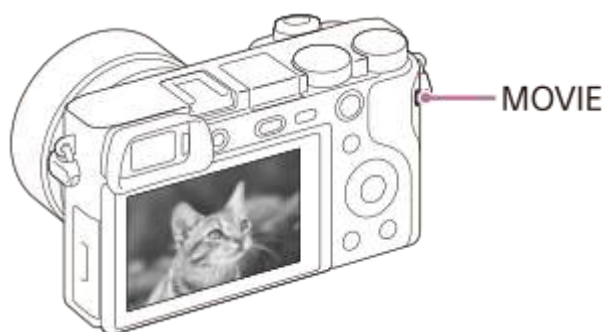

2 Press the MOVIE button again to stop recording.

Hint

- You can assign the start/stop movie recording function to a preferred key. MENU → 2 (Camera Settings2) → Custom Key] → set [MOVIE] to the preferred key.
- When you want to specify the area to be focused on, set the area using [Focus Area].
- To keep the focus on a face, arrange the composition so that the focusing frame and face detection frame overlap, or set the [Focus Area] to [Wide].
- You can focus quickly while shooting movies by pressing the shutter button halfway down. (The sound of auto focus operation may be recorded in some cases.)
- To adjust the shutter speed and aperture value to the desired settings, set the shooting mode to (Movie) and select the desired exposure mode.
- An icon indicating that data is being written is displayed after shooting. Do not remove the memory card while the icon is displayed.
- The following settings for still image shooting are applied to the movie shooting:
 - White Balance
 - Creative Style
 - Metering Mode
 - Face/Eye Priority in AF (The Eye AF function is unavailable during movie shooting.)
 - Face Priority in Multi Metering
 - D-Range Optimizer
 - Lens Comp.
- You can change the settings for ISO sensitivity, exposure compensation, and focus area while shooting movies.
- While shooting movies, the recorded image can be output without the shooting information display by setting [HDMI Info. Display] to [Off].

Note

- The sound of the lens and the product in operation may be recorded during movie recording.
You can turn the sound off by selecting MENU → 2 (Camera Settings2) → [Audio Recording] → [Off].
- When shooting, the sound of the shoulder strap hooks (triangular hook) could be recorded, depending on the situation used.
- To prevent the operating sound of the zoom ring from being recorded during movie recording when a power zoom lens is used, we recommend recording movies using the zoom lever. When you move the zoom lever, place your finger lightly on the lever and operate it without flicking.
- The temperature of the camera tends to rise when shooting movies continuously, and you may feel that the camera is warm. This is not a malfunction. Also, [Internal temp. high. Allow it to cool.] may appear. In such cases, turn the power off and cool the camera and wait until the camera is ready to shoot again.
- If the  icon appears, the temperature of the camera has risen. Turn the power off and cool the camera and wait until the camera is ready to shoot again.
- For the continuous shooting time of a movie recording, refer to “Recordable movie times.” When movie recording is finished, you can record another movie by pressing the MOVIE button again. Recording may stop to protect the product, depending on the temperature of the product or the battery.
- When the mode dial is set to  (Movie) or **S&Q** or when shooting movies, you cannot select [Tracking] for [Focus Area].
- In [Program Auto] mode when shooting movies, the aperture value and the shutter speed will be set automatically and cannot be changed. For that reason, the shutter speed may become fast in a bright environment, and the motion of the subject may not be recorded smoothly. By changing the exposure mode and adjusting the aperture value and the shutter speed, the motion of the subject can be recorded smoothly.
- When shooting movies, ISO values between ISO 100 and ISO 32000 are available. If the ISO value is set to a value larger than ISO 32000, the setting is automatically switched to ISO 32000. When you finish recording the movie, the ISO value returns to the original setting.
- When ISO sensitivity is set to [Multi Frame NR], [ISO AUTO] will be set temporarily.
- In movie shooting mode, the following settings cannot be set in [Picture Effect]. When a movie recording starts, [Off] will be set temporarily.
 - Soft Focus
 - HDR Painting
 - Rich-tone Mono.
 - Miniature
 - Watercolor
 - Illustration
- If you point the camera at an extremely strong light source while shooting a movie at low ISO sensitivity, the highlighted area in the image may be recorded as a black area.
- If the display mode of the monitor is set to [For viewfinder], the display mode will switch to [Display All Info.] when movie shooting starts.
- Use PlayMemories Home when importing XAVC S movies and AVCHD movies to a computer.

Related Topic

- [MOVIE Button](#)
- [Movie w/ shutter](#)
- [File Format \(movie\)](#)
- [Recordable movie times](#)
- [Assigning frequently used functions to buttons \(Custom Key\)](#)
- [Focus Area](#)

Interchangeable Lens Digital Camera
ILCE-6100 α6100

Movie w/ shutter

You can start or stop recording movies by pressing the shutter button, which is bigger and easier to press than the MOVIE (Movie) button.

1 MENU →  (Camera Settings2) → [Movie w/ shutter] → desired setting.

Menu item details

On:

Enables movie recording using the shutter button when the shooting mode is set to [Movie] or [S&Q Motion].

Off:

Disables movie recording using the shutter button.

Hint

- When [Movie w/ shutter] is set to [On], you can still start or stop recording movies using the MOVIE button.

Note

- When [Movie w/ shutter] is set to [On], you cannot focus by pressing the shutter button halfway down during movie recording.

Related Topic

- [Shooting movies](#)

Interchangeable Lens Digital Camera
ILCE-6100 α6100

Movie recording formats

The following movie recording formats are available with this camera.

What is XAVC S?

Records movies in high definition such as 4K by converting them into MP4 movies using the MPEG-4 AVC/H.264 codec. MPEG-4 AVC/H.264 is capable of compressing images with higher efficiency. You can record high-quality images while reducing the amount of data.

XAVC S/AVCHD recording format

XAVC S 4K:

Bit-rate: Approx. 100 Mbps or approx. 60 Mbps

Records movies in 4K resolution (3840×2160).

XAVC S HD:

Bit-rate: Approx. 100 Mbps, approx. 60 Mbps, approx. 50 Mbps, approx. 25 Mbps, or approx. 16 Mbps

Records movies in crisper quality than AVCHD with larger amounts of data.

AVCHD:

Bit-rate: Approx. 24 Mbps (maximum) or approx. 17 Mbps (average)

The AVCHD format has a high degree of compatibility with storage devices other than computers.

- Bit rate is the amount of data processed within a given period of time.



Related Topic

- [File Format \(movie\)](#)
- [Record Setting \(movie\)](#)
- [AVCHD format](#)

Interchangeable Lens Digital Camera
ILCE-6100 α6100

File Format (movie)

Selects the movie file format.

1 MENU →  2 (Camera Settings2) → [ File Format] → desired setting.

Menu item details

 File Format	Characteristics	
XAVC S 4K	Records movies in 4K resolution (3840×2160).	You can save movies on a computer using the PlayMemories Home software.
XAVC S HD	Records movies in crisper quality than AVCHD with larger amounts of data.	
AVCHD	The AVCHD format has a high degree of compatibility with storage devices other than computers.	You can save movies on a computer or create a disc that supports this format using the PlayMemories Home software.



Note

- When [ File Format] is set to [AVCHD], the file size of movies is limited to approx. 2 GB. If the movie file size reaches approx. 2 GB during recording, a new movie file will be created automatically.

Interchangeable Lens Digital Camera
ILCE-6100 α6100

Record Setting (movie)





Selects the frame rate and bit-rate for movie recording.

1 MENU →  (Camera Settings2) → [ Record Setting] → desired setting.

- The higher the bit-rate, the higher the image quality.











Menu item details

When [ File Format] is set to [XAVC S 4K]

 Record Setting	Bit-rate	Description
30p 100M/ 25p 100M 	Approx. 100 Mbps	Records movies in 3840×2160 (30p/25p).
30p 60M/ 25p 60M 	Approx. 60 Mbps	Records movies in 3840×2160 (30p/25p).
24p 100M  *	Approx. 100 Mbps	Records movies in 3840×2160 (24p).
24p 60M  *	Approx. 60 Mbps	Records movies in 3840×2160 (24p).

* Only when [NTSC/PAL Selector] is set to NTSC





When [ File Format] is set to [XAVC S HD]

 Record Setting	Bit-rate	Description
60p 50M  /50p 50M 	Approx. 50 Mbps	Records movies in 1920×1080 (60p/50p).
60p 25M  /50p 25M 	Approx. 25 Mbps	Records movies in 1920×1080 (60p/50p).
30p 50M  /25p 50M 	Approx. 50 Mbps	Records movies in 1920×1080 (30p/25p).
30p 16M  /25p 16M 	Approx. 16 Mbps	Records movies in 1920×1080 (30p/25p).
24p 50M  *	Approx. 50 Mbps	Records movies in 1920×1080 (24p).
120p 100M/100p 100M	Approx. 100 Mbps	Records high-speed movies in 1920×1080 (120p/100p). You can record movies in 120 fps or 100 fps. <ul style="list-style-type: none"> • You can create smoother slow-motion movies by using compatible editing devices.







 Record Setting	Bit-rate	Description
120p 60M/100p 60M	Approx. 60 Mbps	Records high-speed movies in 1920×1080 (120p/100p). You can record movies in 120 fps or 100 fps. <ul style="list-style-type: none"> You can create smoother slow-motion movies by using compatible editing devices.

* Only when [NTSC/PAL Selector] is set to NTSC

When [File Format] is set to [AVCHD]

 Record Setting	Bit-rate	Description
60i 24M(FX)  /50i 24M(FX) 	24 Mbps at maximum	Records movies in 1920×1080 (60i/50i).
60i 17M(FH)  /50i 17M(FH) 	Approx. 17 Mbps on average	Records movies in 1920×1080 (60i/50i).

Note

- Creating an AVCHD recording disc from movies that were recorded with [60i 24M(FX) ]/[50i 24M(FX)  Record Setting] takes a long time because the image quality of movies is converted. If you want to store movies without converting them, use a Blu-ray Disc.
- [120p]/[100p] cannot be selected for the following settings.
 - [Intelligent Auto]
 - [Superior Auto]
 - [Scene Selection]
- The angle of view will be narrower under the following conditions:
 - When [ File Format] is set to [XAVC S HD] and [ Record Setting] is set to [120p]/[100p]
 - When [ File Format] is set to [XAVC S 4K] and [ Record Setting] is set to [30p]
 - During slow-motion/quick-motion shooting

S&Q Settings

You can record a moment that cannot be captured by the naked eye (slow-motion recording), or record a long-term phenomenon into a compressed movie (quick-motion recording). For example, you can record an intense sports scene, the moment when a bird starts to fly, a blooming flower, and a changing view of clouds or a starry sky. Sound will not be recorded.

- 1 Set the mode dial to **S&Q** (S&Q Motion).
- 2 Select **MENU** → 2 (Camera Settings2) → [**S&Q** Exposure Mode] → and select the desired setting of slow-motion/quick-motion (**S&Q** Program Auto, **S&Q** Aperture Priority, **S&Q** Shutter Priority, or **S&Q** Manual Exposure).
- 3 Select **MENU** → 2 (Camera Settings2) → [**S&Q** S&Q Settings] and select the desired settings for [**S&Q** Record Setting] and [**S&Q** Frame Rate].
- 4 Press the **MOVIE** (movie) button to start recording.
 - Press the **MOVIE** button again to stop recording.

Menu item details

S&Q Record Setting:

Selects the frame rate of the movie.

S&Q Frame Rate:

Selects the shooting frame rate.

Playback speed

The playback speed will vary as below depending on the assigned [**S&Q** Record Setting] and [**S&Q** Frame Rate].

When [NTSC/PAL Selector] is set to NTSC

S&Q Frame Rate	S&Q Record Setting		
	24p	30p	60p
120fps	5 times slower	4 times slower	-
60fps	2.5 times slower	2 times slower	Normal playback speed
30fps	1.25 times slower	Normal playback speed	2 times quick
15fps	1.6 times quick	2 times quick	4 times quick
8fps	3 times quick	3.75 times quick	7.5 times quick
4fps	6 times quick	7.5 times quick	15 times quick
2fps	12 times quick	15 times quick	30 times quick
1fps	24 times quick	30 times quick	60 times quick

When [NTSC/PAL Selector] is set to PAL

S&Q Frame Rate	S&Q Record Setting	
	25p	50p
100fps	4 times slower	-
50fps	2 times slower	Normal playback speed
25fps	Normal playback speed	2 times quick
12fps	2.08 times quick	4.16 times quick
6fps	4.16 times quick	8.3 times quick
3fps	8.3 times quick	16.6 times quick
2fps	12.5 times quick	25 times quick
1fps	25 times quick	50 times quick

- When [S&Q Frame Rate] is set to [120fps]/[100fps], you cannot set [S&Q Record Setting] to [60p]/[50p].

Note

- In slow-motion recording, the shutter speed becomes faster and you may not be able to obtain the proper exposure. If this happens, decrease the aperture value or adjust the ISO sensitivity to a higher value.
- For an estimation of recordable time, refer to "Recordable movie times."
- The bit-rate of a recorded movie varies depending on the settings for [S&Q Frame Rate] and [S&Q Record Setting].
- The movie will be recorded in XAVC S HD format.
- During slow-motion/quick-motion recording, the following functions are not available.
 - [4K Output Select]



Related Topic

- [S&Q Motion: Exposure Mode](#)
- [Recordable movie times](#)

Interchangeable Lens Digital Camera
ILCE-6100 α6100

Proxy Recording

Sets whether to simultaneously record low-bit-rate proxy movies when recording XAVC S movies. Since proxy movies are small in file size, they are suitable for transferring to smartphones or uploading to websites.

1 MENU →  2 (Camera Settings2) → [ Proxy Recording] → desired setting.

Menu item details

On :

Proxy movies are simultaneously recorded.



Off :

Proxy movies are not recorded.

Hint

- Proxy movies are recorded in the XAVC S HD format (1280×720) at 9 Mbps. The frame rate of the proxy movie is the same as that of the original movie.
- Proxy movies are not displayed on the playback screen (single-image playback screen or image index screen).  is displayed over movies for which a proxy movie was simultaneously recorded.

Note

- Proxy movies cannot be played back on this camera.
- Proxy recording is not available in the following situations.
 - When [ File Format] is set to [AVCHD]
 - When [ File Format] is set to [XAVC S HD] and [ Record Setting] is set to [120p]/[100p]
- Deleting/protecting movies that have proxy movies removes/protects both the original and proxy movies. You cannot delete/protect only original movies or proxy movies.
- Movies cannot be edited on this camera.

Related Topic

- [Send to Smartphone Func.: Sending Target \(proxy movies\)](#)
- [Movie recording formats](#)
- [Playing back images on the image index screen \(Image Index\)](#)
- [Memory cards that can be used](#)

Interchangeable Lens Digital Camera
ILCE-6100 α6100

Audio Recording

Sets whether to record sounds when shooting movies. Select [Off] to avoid recording the sounds of the lens and the camera operating.

1 MENU →  **2** (Camera Settings2) → [Audio Recording] → desired setting.

Menu item details

On:

Records sound (stereo).

Off:

Does not record sound.

Audio Level Display

Sets whether to display the audio level on the screen.

1 MENU →  2 (Camera Settings2) → [Audio Level Display] → desired setting.

Menu item details

On:

Displays the audio level.

Off:

Does not display the audio level.

Note

- The audio level is not displayed in the following situations:
 - When [Audio Recording] is set to [Off].
 - When DISP (Display Setting) is set to [No Disp. Info.].
 - During slow-motion/quick-motion shooting
- The audio level is also displayed while shooting stand-by in movie recording mode.

Interchangeable Lens Digital Camera
ILCE-6100 α6100

Audio Rec Level

You can adjust the audio recording level while checking the level meter.

- 1 MENU →  2 (Camera Settings2) → [Audio Rec Level].
- 2 Select the desired level using the right/left sides of the control wheel.

Menu item details

+:

Turns up the audio recording level.

-:

Turns down the audio recording level.

Reset:

Resets the audio recording level to the default setting.

Hint

- When you record audio movies with loud volumes, set [Audio Rec Level] to a lower sound level. Doing so enables you to record more realistic audio. When you record audio movies with lower volumes, set [Audio Rec Level] to a greater sound level to make the sound easier to hear.

Note

- Regardless of the [Audio Rec Level] settings, the limiter always operates.
- [Audio Rec Level] is available only when the shooting mode is set to movie mode.
- [Audio Rec Level] is unavailable during slow-motion/quick-motion shooting.
- The [Audio Rec Level] settings are applied for both the internal microphone and the  (microphone) terminal input.

Interchangeable Lens Digital Camera
ILCE-6100 α6100

Wind Noise Reduct.

Sets whether or not to reduce wind noise by cutting the low-range sound of the input audio from the built-in microphone.

1 MENU →  2 (Camera Settings2) → [Wind Noise Reduct.] → desired setting.

Menu item details

On:

Reduces wind noise.

Off:



Does not reduce wind noise.

Note

- Setting this item to [On] where wind is not blowing sufficiently hard may cause normal sound to be recorded with too low volume.
- When an external microphone (sold separately) is used, [Wind Noise Reduct.] does not function.

Auto Slow Shutter (movie)

Sets whether or not to adjust the shutter speed automatically when recording movies if the subject is dark.

1 MENU →  2 (Camera Settings2) → [ Auto Slow Shutter] → **desired setting.**

Menu item details



On:

Uses Auto Slow Shutter. The shutter speed automatically slows when recording in dark locations. You can reduce noise in the movie by using a slow shutter speed when recording in dark locations.

Off:

Does not use Auto Slow Shutter. The recorded movie will be darker than when [On] is selected, but you can record movies with smoother motion and less object blur.



Note

- [ Auto Slow Shutter] does not function in the following situations:
 - During slow-motion/quick-motion shooting
 -  s (Shutter Priority)
 -  M (Manual Exposure)
 - When [ISO] is set to other than [ISO AUTO]

Interchangeable Lens Digital Camera
ILCE-6100 α6100

Initial Focus Mag. (movie)

Sets the initial magnification scale for [Focus Magnifier] in the movie shooting mode.

① MENU →  (Camera Settings2) → [ Initial Focus Mag.] → **desired setting.**

Menu item details

x1.0:

Displays the image with the same magnification as the shooting screen.

x4.0:

Displays a 4.0-times enlarged image.



Related Topic

- [Focus Magnifier](#)

Interchangeable Lens Digital Camera
ILCE-6100 α6100

AF drive speed (movie)

You can switch focusing speed when using autofocus in movie mode.

1 MENU →  2 (Camera Settings2) → [ AF drive speed] → desired setting.

Menu item details

Fast:

Sets the AF drive speed to fast. This mode is suitable for shooting active scenes, such as sports.

Normal:

Sets the AF drive speed to normal.



Slow:

Sets the AF drive speed to slow. With this mode, the focus switches smoothly when the subject to be focused is changed.

Interchangeable Lens Digital Camera
ILCE-6100 α6100

AF Tracking Sens. (movie)

You can set the AF sensitivity in movie mode.

1 MENU →  2 (Camera Settings2) → [ AF Tracking Sens.] → desired setting.

Menu item details

Responsive:

Sets the AF sensitivity to high. This mode is useful when recording movies in which the subject is moving quickly.

Standard:

Sets the AF sensitivity to normal. This mode is useful when there are obstacles in front of the subject or in crowded places.

Interchangeable Lens Digital Camera
ILCE-6100 α6100

MOVIE Button

Sets whether or not to activate the MOVIE (Movie) button.

1 MENU →  2 (Camera Settings2) → [MOVIE Button] → desired setting.

Menu item details

Always:

Starts movie recording when you press the MOVIE button in any mode.



Movie Mode Only:

Starts movie recording when you press the MOVIE button only if the shooting mode is set to [Movie] or [S&Q Motion] mode.

Interchangeable Lens Digital Camera
ILCE-6100 α6100

Marker Display (movie)

Sets whether or not to display markers set using [ Marker Settings] on the monitor or the viewfinder while shooting movies.

① MENU →  (Camera Settings2) → [ Marker Display] → **desired setting.**

Menu item details

On:

Markers are displayed. The markers are not recorded.

Off:

No marker is displayed.

Note

- The markers are displayed when the mode dial is set to  (Movie) or **S&Q**, or when shooting movies.
- You cannot display markers when using [Focus Magnifier].
- The markers are displayed on the monitor or viewfinder. (You cannot output the markers.)



Related Topic

- [Marker Settings \(movie\)](#)

Interchangeable Lens Digital Camera
ILCE-6100 α6100

Marker Settings (movie)

Sets the markers to be displayed while shooting movies.

1 MENU →  2 (Camera Settings2) → [ Marker Settings] → desired setting.

Menu item details

Center:

Sets whether or not to display the center marker in the center of the shooting screen.

[Off]/[On]

Aspect:

Sets the aspect marker display.

[Off]/[4:3]/[13:9]/[14:9]/[15:9]/[1.66:1]/[1.85:1]/[2.35:1]

Safety Zone:

Sets the safety zone display. This becomes the standard range that can be received by a general household TV.

[Off]/[80%]/[90%]

Guideframe:

Sets whether or not to display the guide frame. You can verify whether the subject is level or perpendicular to the ground.

[Off]/[On]



Hint

- You can display several markers at the same time.
- Place the subject on the cross point of the [Guideframe] to make a balanced composition.

Interchangeable Lens Digital Camera
ILCE-6100 α6100

4K Output Select (movie)

You can set how to record movies and perform HDMI output when your camera is connected to 4K-compatible external recording/playback devices, etc.

- 1 Turn the mode dial to  (movie).
- 2 Connect the camera to the desired device via an HDMI cable.
- 3 MENU →  (Setup) → [ 4K Output Select] → desired setting.

Menu item details

Memory Card+HDMI:

Simultaneously outputs to the external recording/playback device and records on the camera's memory card.

HDMI Only(30p):

Outputs a 4K movie in 30p to the external recording/playback device without recording on the camera's memory card.

HDMI Only(24p) ^{Super}_{35mm} :



Outputs a 4K movie in 24p to the external recording/playback device without recording on the camera's memory card.

HDMI Only(25p) ^{Super}_{35mm} *:

Outputs a 4K movie in 25p to the external recording/playback device without recording on the camera's memory card.

* Only when [NTSC/PAL Selector] is set to PAL.

Note

- This item can be set only when the camera is in movie mode and connected to a 4K-compatible device.
- When [HDMI Only(30p)], [HDMI Only(24p) ^{Super}_{35mm}] or [HDMI Only(25p) ^{Super}_{35mm}] is set, [HDMI Info. Display] will temporarily be set to [Off].
- A 4K movie is not output to the connected 4K-compatible device during slow-motion/quick-motion shooting.
- When [HDMI Only(30p)], [HDMI Only(24p) ^{Super}_{35mm}] or [HDMI Only(25p) ^{Super}_{35mm}] is set, the counter does not move forward (the actual recording time is not counted) while the movie is being recorded on an external recording/playback device.
- When shooting 4K movies using the setting [Memory Card+HDMI], the movies will not be output to a device connected by HDMI cable if you simultaneously record a proxy movie. If you want to perform HDMI output, set [ Proxy Recording] to [Off]. (In this case, the image will not be displayed on the screen of the camera).
- When [ File Format] is set to [XAVC S 4K] and the camera is connected via HDMI, the following functions are not available.
 - [Face/Eye Priority in AF]
 - [Face Priority in Multi Metering]
 - Tracking function

Related Topic

- [File Format \(movie\)](#)
- [Record Setting \(movie\)](#)
- [HDMI Settings: HDMI Info. Display](#)

Interchangeable Lens Digital Camera
ILCE-6100 α6100

Playing back still images

Plays back the recorded images.

- 1 Press the  (Playback) button to switch to the playback mode.
- 2 Select the image with the control wheel.
 - Images shot with continuous shooting or interval shooting are displayed as one group. To play back the images in the group, press the center of the control wheel.

Hint

- The product creates an image database file on a memory card to record and play back images. An image that is not registered in the image database file may not be played back correctly. To play back images shot using other devices, register those images to the image database file using MENU →  (Setup) → [Recover Image DB].
- If you play back the images right after continuous shooting, the monitor may display an icon indicating that data is being written/the number of images left to write. During writing, some functions are not available.
- You can also enlarge an image by double-tapping the monitor. In addition, you can drag and move the magnified position on the monitor. Set [Touch Operation] to [On] beforehand.

Related Topic

- [Recover Image DB](#)
- [Display as Group](#)



Interchangeable Lens Digital Camera
ILCE-6100 α6100

Enlarging an image being played back (Enlarge Image)

Enlarges the image being played back. Use this function to check the focus of the image, etc.

- 1 Display the image you want to enlarge, and then press the  button.**
 - Turn the control wheel to adjust the zoom scale. By rotating the control dial, you can switch to the previous or next image while keeping the same zoom scale.
 - The view will zoom in on the part of the image where the camera focused during shooting. If the focus location information cannot be obtained, the camera will zoom in on the center of the image.
- 2 Select the portion you want to enlarge by pressing the top/bottom/right/left sides of the control wheel.**
- 3 Press the MENU button or the center of the control wheel to exit the playback zoom.**

Hint

- You can also enlarge an image being played back using MENU.
- You can change the initial magnification and initial position of enlarged images by selecting MENU →  (Playback) → [ Enlarge Initial Mag.] or [ Enlarge Initial Position].
- You can also enlarge an image by double-tapping the monitor. In addition, you can drag and move the magnified position on the monitor. Set [Touch Operation] to [On] beforehand.

Note

- You cannot enlarge movies.

Related Topic

- [Touch Operation](#)
- [Enlarge Initial Mag.](#)
- [Enlarge Initial Position](#)

Rotating recorded images automatically (Display Rotation)

Selects the orientation when playing back recorded images.

1 MENU →  (Playback) → [Display Rotation] → desired setting.

Menu item details

Manual:

Images shot vertically are displayed vertically. If you have set the image orientation using the [Rotate] function, the image will be displayed accordingly.

Off:

Images are always displayed horizontally.

Related Topic

- [Rotating an image \(Rotate\)](#)

Rotating an image (Rotate)

Rotates a recorded image counter-clockwise.

1 Display the image to be rotated, then select **MENU** →  (Playback) → **[Rotate]**.

2 Press the center of the control wheel.

The image is rotated counter-clockwise. The image rotates as you press the center.

If you rotate the image once, the image remains rotated even after the product is turned off.

Note

- You cannot rotate the movies.
- You may not be able to rotate images shot using other products.
- When viewing rotated images on a computer, the images may be displayed in their original orientation depending on the software.

Playing back panoramic images

The product automatically scrolls a panoramic image from end to end.

- 1 Press the  (Playback) button to switch to playback mode.
- 2 Select the panoramic image to be played back using the control wheel and press the center to start playback.



- To pause playback, press the center again.
- To scroll panoramic images manually, press the top/bottom/right/left during pause.
- To return to the display of the entire image, press the MENU button.

Note

- Panoramic images shot using other products may be displayed in a different size from the actual size, or may not scroll correctly.

Interchangeable Lens Digital Camera
ILCE-6100 α6100

Enlarge Initial Mag.

Sets the initial magnification scale when playing back enlarged images.

1 MENU →  (Playback) → [ Enlarge Initial Mag.] → desired setting.

Menu item details

Standard. Mag.:

Displays an image with the standard magnification.

Previous Mag.:

Displays an image with the previous magnification. The previous magnification is stored even after exiting the playback zoom mode.

Related Topic

- [Enlarging an image being played back \(Enlarge Image\)](#)
- [Enlarge Initial Position](#)

Enlarge Initial Position

Sets the initial position when enlarging an image in playback.

1 MENU →  (Playback) → [ Enlarge Initial Position] → desired setting.

Menu item details

Focused Position:

Enlarges the image from the point of focus during shooting.

Center:

Enlarges the image from the center of the screen.

Related Topic

- [Enlarging an image being played back \(Enlarge Image\)](#)
- [Enlarge Initial Mag.](#)













Playing back movies

Plays back the recorded movies.

- 1 Press the  (playback) button to switch to playback mode.
- 2 Select the movie to be played back using the control wheel and press the center of the control wheel to start playback.

Available operations during movie playback

You can perform slow playback and sound volume adjustment, etc. by pressing the down side of the control wheel.

-  : Playback
-  : Pause
-  : Fast-forward
-  : Fast-rewind
-  : Forward slow playback
-  : Reverse slow playback
-  : Next movie file
-  : Previous movie file
-  : Displays the next frame
-  : Displays the previous frame
-  : Photo Capture
-  : Sound volume adjustment
-  : Closes the operation panel

Hint

- “Forward slow playback,” “Reverse slow playback,” “Displays the next frame” and “Displays the previous frame” are available during pause.
- Movie files recorded using other products may not be able to be playable on this camera.

Related Topic

- [Switching between still images and movies \(View Mode\)](#)

Interchangeable Lens Digital Camera
ILCE-6100 α6100

Volume Settings

Sets the sound volume for movie playback.



① MENU →  (Setup) → [Volume Settings] → desired setting.

Adjusting the volume during playback

Press the bottom side of the control wheel while playing back movies to display the operation panel, then adjust the volume. You can adjust the volume while listening to the actual sound.

Photo Capture

Captures a chosen scene in a movie to save as a still image. First shoot a movie, then pause the movie during playback to capture decisive moments that tend to be missed when shooting still images, and save them as still images.

- 1 Display the movie that you want to capture as a still image.**
- 2 MENU →  (Playback) → [Photo Capture].**
- 3 Play back the movie and pause it.**
- 4 Find the desired scene using forward slow playback, reverse slow playback, displays the next frame, and displays the previous frame, and then stop the movie.**
- 5 Press  (Photo Capture) to capture the chosen scene.**
The scene is saved as a still image.

Related Topic

- [Shooting movies](#)
- [Playing back movies](#)

Playing back images on the image index screen (Image Index)

You can display multiple images at the same time in playback mode.

- 1 Press the  (Image Index) button while the image is being played back.
- 2 Select the image by pressing the top/bottom/right/left sides of the control wheel or turning the control wheel.

To change the number of images to be displayed

MENU →  (Playback) → [Image Index] → desired setting.

Menu item details

12 Images/30 Images

To return to single-image playback

Select the desired image and press the center of the control wheel.

To display a desired image quickly

Select the bar on the left of the image index screen using the control wheel, then press the top/bottom sides of the control wheel. While the bar is being selected, you can display the calendar screen or folder selection screen by pressing the center. In addition, you can switch View Mode by selecting an icon.

Related Topic

- [Switching between still images and movies \(View Mode\)](#)

Interchangeable Lens Digital Camera
ILCE-6100 α6100

Setting the method for jumping between images (Image Jump Setting)

Sets which dial and method to use for jumping between images during playback. You can quickly find protected images or images set with a particular rating.

1 MENU →  (Playback) → [Image Jump Setting] → desired item.

Menu item details

Select Dial/Wheel:

Selects the dial or wheel to use for jumping between images.

Image Jump Method:

Sets the method for playing back with Image Jump.

Note

- [Image Jump Setting] is available only when [View Mode] is set to [Date View]. If [View Mode] is not set to [Date View], the camera will always play back every image without jumping when you use the dial selected with [Select Dial/Wheel].
- When you use the Image Jump function, movie files are always skipped.

Related Topic

- [Rating](#)
- [Protecting images \(Protect\)](#)

Switching between still images and movies (View Mode)

Sets the View Mode (image display method).

① MENU →  (Playback) → [View Mode] → desired setting.

Menu item details

Date View:

Displays the images by date.

Folder View(Still):

Displays only still images.

AVCHD View:

Displays only AVCHD-format movies.

XAVC S HD View:

Displays only XAVC S HD-format movies.

XAVC S 4K View:

Displays only XAVC S 4K-format movies.

Display as Group

Sets whether or not to display continuously shot images or images shot using interval shooting as a group.

1 MENU →  (Playback) → [Display as Group] → desired setting.

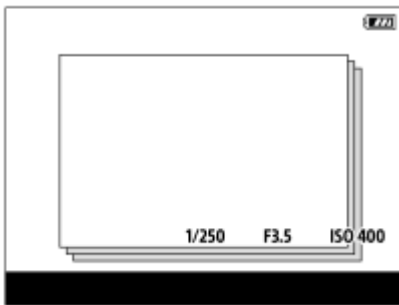

Menu item details



On:

Displays images as a group.

Off:

Does not display images as a group.

Hint

- The following images are grouped.
 - Images shot with [Drive Mode] set to [Cont. Shooting] (One sequence of images shot continuously by holding down the shutter button during continuous shooting becomes one group.)
 - Images shot with [ Interval Shoot Func.] (Images shot during one session of interval shooting become one group.)
- On the image index screen,  is displayed over the group.

Note

- Images can be grouped and displayed only when [View Mode] is set to [Date View]. When it is not set to [Date View], images cannot be grouped and displayed, even if [Display as Group] is set to [On].
- If you delete the group, all the images in the group will be deleted.

Related Topic



- [Cont. Shooting](#)
- [Interval Shoot Func.](#)

Interchangeable Lens Digital Camera
ILCE-6100 α6100



Cont. PB for Interval

Continuously plays back images shot using interval shooting.

You can create movies from still images produced by interval shooting using the computer software Imaging Edge (Viewer). You cannot create movies from the still images on the camera.

- 1 **MENU** →  (Playback) → [Cont. PB for  Interval].
- 2 **Select the image group that you want to play back, and then press the center of the control wheel.**

Hint

- On the playback screen, you can start continuous playback by pressing the down button while displaying an image in the group.
- You can resume play or pause by pressing the down button during playback.
- You can change the playback speed by turning the control dial or the control wheel during playback. You can also change the playback speed by selecting **MENU** →  (Playback) → [PB Speed for  Interval].
- You can continuously play back images shot with continuous shooting as well.

Related Topic

- [Interval Shoot Func.](#)
- [PB Speed for Interval](#)
- [Imaging Edge](#)

Interchangeable Lens Digital Camera
ILCE-6100 α6100

PB Speed for Interval

Sets the playback speed for still images during [Cont. PB for  Interval].

1 MENU →  (Playback) → [PB Speed for  Interval] → desired setting.

Hint

- You can also change the playback speed by turning the control dial or the control wheel during [Cont. PB for  Interval].

Related Topic

- [Cont. PB for Interval](#)

Interchangeable Lens Digital Camera
ILCE-6100 α6100

Playing back images using slideshow (Slide Show)

Automatically plays back images continuously.

- 1 MENU →  (Playback) → [Slide Show] → desired setting.
- 2 Select [Enter].

Menu item details

Repeat:

Select [On], in which images are played back in a continuous loop, or [Off], in which the product exits the slideshow when all the images are played back once.

Interval:

Select the display interval for images from among [1 Sec], [3 Sec], [5 Sec], [10 Sec] or [30 Sec].

To quit the slideshow in the middle of playback

Press the MENU button to quit the slideshow. You cannot pause the slideshow.

Hint

- During playback, you can display the next/previous image by pressing the right/left side of the control wheel.
- You can activate a slideshow only when [View Mode] is set to [Date View] or [Folder View(Still)].

Protecting images (Protect)



Protects recorded images against accidental erasure. The  mark is displayed on protected images.

① MENU →  (Playback) → [Protect] → desired setting.

Menu item details

Multiple Img.:

Applies the protection of the selected multiple images.

(1) Select the image to be protected, then press the center of the control wheel. The  mark is displayed in the check box. To cancel the selection, press the center again to remove the  mark.

(2) To protect other images, repeat step (1).

(3) MENU → [OK].

All in this Folder:

Protects all images in the selected folder.

All with this date:

Protects all images taken on the selected date.

Cancel All in this Folder:

Cancels the protection of all images in the selected folder.

Cancel All with this date:

Cancels the protection of all images taken on the selected date.



All Images in This Group:

Protects all the images in the selected group.

Cancel All in This Group:

Cancels the protection of all the images in the selected group.

Hint

- If you assign [Protect] to the key of your choice using MENU →  2 (Camera Settings2) → [ Custom Key], you can protect images or cancel protection by simply pressing the key.
- If you select a group in [Multiple Img.], all the images in the group will be protected. To select and protect particular images within the group, execute [Multiple Img.] while displaying the images within the group.

Note

- The menu items that can be selected vary according to the [View Mode] setting and the selected content.

Rating

You can assign ratings to recorded images on a scale from ★ to ★★★ to make it easier to find images. Combining this function with [Image Jump Setting] allows you to find a desired image quickly.

- 1 MENU →  (Playback) → [Rating].**
The image rating selection screen will appear.
- 2 Press the left/right sides of the control wheel to display an image to which you want to assign a rating, and then press the center.**
- 3 Select the number of ★ (Rating) by pressing the left/right sides of the control wheel, and then press the center.**
- 4 Press the MENU button to exit the rating setting screen.**

Hint

- You can also assign ratings when playing back images by using the custom key. Assign [Rating] to the desired key using [ Custom Key] beforehand, and then press the custom key while playing back an image to which you want to assign a rating. The number of ★ (Rating) changes each time you press the custom key.

Note

- You can assign ratings to still images only.



Related Topic

- [Assigning frequently used functions to buttons \(Custom Key\)](#)
- [Rating Set\(Custom Key\)](#)
- [Setting the method for jumping between images \(Image Jump Setting\)](#)

Interchangeable Lens Digital Camera
ILCE-6100 α6100

Rating Set(Custom Key)

Sets the available number of ★ when rating images with the key to which you have assigned [Rating] using [ Custom Key].

- 1 **MENU** →  (Playback) → [Rating Set(Custom Key)].
 - 2 Add a  mark to the number of ★ that you want to activate.
You can select the checked number when setting [Rating] using the custom key.
-

Related Topic

- [Rating](#)
- [Assigning frequently used functions to buttons \(Custom Key\)](#)

Interchangeable Lens Digital Camera
ILCE-6100 α6100

Specifying images to be printed (Specify Printing)



You can specify in advance on the memory card which still images you want to print out later. The **DPOF** (print order) icon will appear on the specified images. DPOF refers to “Digital Print Order Format.” DPOF setting will be retained after the image is printed. We recommend that you cancel this setting after printing.

1 MENU →  (Playback) → [Specify Printing] → desired setting.

Menu item details

Multiple Img.:

Selects images to order printing.

(1) Select an image and press the center of the control wheel. The  mark is displayed in the check box. To cancel the selection, press the center again and delete the  mark.

(2) Repeat step (1) to print other images. To select all the images from a certain date or in a certain folder, select the check box for the date or folder.

(3) MENU → [OK].

Cancel All:

Clears all DPOF marks.

Print Setting:

Sets whether to print the date on images registered with DPOF marks.

- The position or size of the date (inside or outside of the image) may differ depending on the printer.

Note

- You cannot add the DPOF mark to the following files:
 - RAW images
- The number of copies cannot be specified.
- Some printers do not support the date print function.

Interchangeable Lens Digital Camera
ILCE-6100 α6100

Deleting a displayed image

You can delete an image displayed. Once you have deleted an image, you cannot restore it. Confirm the image to be deleted beforehand.

- 1 Display the image you want to delete.
- 2 Press the  (Delete) button.
- 3 Select [Delete] using the control wheel.

Note

- The protected images cannot be deleted.

Related Topic

- [Deleting multiple selected images \(Delete\)](#)

Deleting multiple selected images (Delete)



You can delete multiple selected images. Once you have deleted an image, you cannot restore it. Confirm the image to be deleted beforehand.

- 1 MENU →  (Playback) → [Delete] → desired setting.

Menu item details

Multiple Img.:

Deletes the selected images.

(1) Select the images to be deleted, then press the center of the control wheel. The  mark is displayed in the check box. To cancel the selection, press the center again to remove the  mark.

(2) To delete other images, repeat step (1).

(3) MENU → [OK].

All in this Folder:

Deletes all images in the selected folder.

All with this date:

Deletes all images taken on the selected date.

All Other Than This Img.:

Deletes all images in the group except the selection.

All Images in This Group:

Deletes all images in the selected group.

Hint

- Perform [Format] to delete all images, including protected images.
- To display the desired folder or date, select the desired folder or date during playback by performing the following procedure:
 (Image Index) button → select the bar on the left using the control wheel → select the desired folder or date using the top/bottom sides of the control wheel.
- If you select a group in [Multiple Img.], all the images in the group will be deleted. To select and delete particular images within the group, execute [Multiple Img.] while displaying the images within the group.

Note

- The protected images cannot be deleted.
- The menu items that can be selected vary according to the [View Mode] setting and the selected content.

Related Topic

- [Deleting a displayed image](#)
- [Format](#)

Interchangeable Lens Digital Camera
ILCE-6100 α6100

Delete confirm.

You can set whether [Delete] or [Cancel] is selected as a default on the delete confirmation screen.

1 MENU →  (Setup) → [Delete confirm.] → desired setting.

Menu item details

"Delete" first:

[Delete] is selected as the default setting.

"Cancel" first:

[Cancel] is selected as the default setting.

Interchangeable Lens Digital Camera
ILCE-6100 α6100

Viewing images on a TV using an HDMI cable

To view images stored on this product using a TV, an HDMI cable (sold separately) and an HD TV equipped with an HDMI jack are required.

- 1 Turn off both this product and the TV.
- 2 Connect the HDMI micro terminal of this product to the HDMI jack of the TV using an HDMI cable (sold separately).

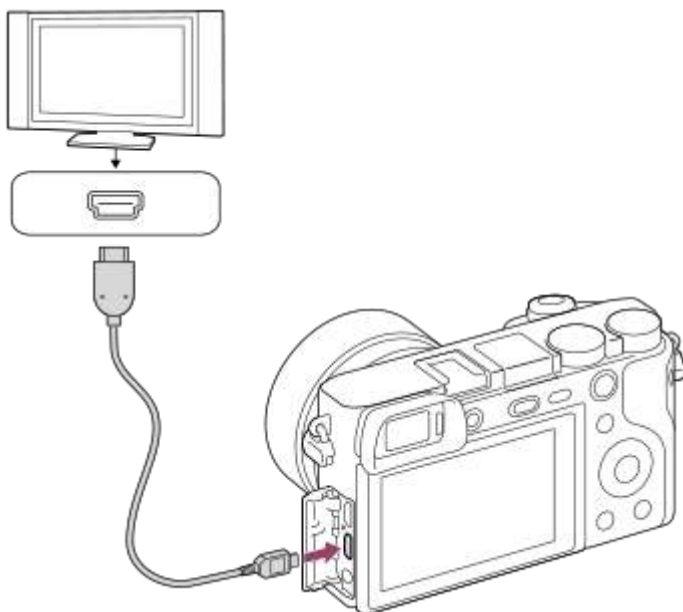

- 3 Turn on the TV and switch the input.
- 4 Turn on this product.
Images shot with the product appear on the TV screen.
- 5 Select an image using the right/left sides of the control wheel.
 - The monitor of this camera is not lit up on the playback screen.
 - If the playback screen is not displayed, press the  (Playback) button.

“BRAVIA” Sync

By connecting this product to a TV that supports “BRAVIA” Sync using an HDMI cable (sold separately), you can operate this product’s playback functions with the TV remote control.



1. After performing the steps above to connect this camera to a TV, select MENU →  (Setup) → [HDMI Settings] → [CTRL FOR HDMI] → [On].
2. Press the SYNC MENU button on the TV remote control, and select the desired mode.
 - If you connect this camera to a TV using an HDMI cable, available menu items are limited.

- Only TVs that support “BRAVIA” Sync can provide SYNC MENU operations. For details, refer to the operating instructions supplied with the TV.
- If the product performs unwanted operations in response to the TV remote control when the product is connected to another manufacturer’s TV using an HDMI connection, select MENU →  (Setup) → [HDMI Settings] → [CTRL FOR HDMI] → [Off].

Hint

- This product is compatible with the PhotoTV HD standard. If you connect Sony PhotoTV HD-compatible devices using an HDMI cable (sold separately), the TV is set to the image quality suitable for viewing still images, and a whole new world of photos can be enjoyed in breathtaking high quality.
- You can connect this product to Sony PhotoTV HD-compatible devices with a USB terminal using the USB cable.
- The PhotoTV HD allows for a highly-detailed, photo-like expression of subtle textures and colors.
- For details, refer to the operating instructions supplied with the compatible TV.





Note

- Do not connect this product and another device using the output terminals of both. Doing so may cause a malfunction.
- Some devices may not work properly when connected to this product. For example, they may not output video or audio.
- Use an HDMI cable with the HDMI logo or a genuine Sony cable.
- Use an HDMI cable that is compatible with the HDMI micro terminal of the product and the HDMI jack of the TV.
- If images do not appear on the TV screen properly, select MENU →  (Setup) → [HDMI Settings] → [HDMI Resolution] → [2160p/1080p], [1080p] or [1080i] according to the TV to be connected.
- During HDMI output, when you switch the movie from 4K to HD image quality or vice-versa, or change the movie to a different frame rate, the screen may become dark. This is not a malfunction.
- When [ Proxy Recording] is set to [On], images cannot be output to an HDMI device while recording a 4K movie.

Interchangeable Lens Digital Camera
ILCE-6100 α6100

Memory (Camera Settings1/Camera Settings2)

Allows you to register up to 3 often-used modes or product settings to the product and up to 4 (M1 through M4) to the memory card. You can recall the settings using just the mode dial.

- 1 Set the product to the setting you want to register.
- 2 MENU →  1 (Camera Settings1) → [  1 /  2 Memory] → desired number.
- 3 Press the center of the control wheel to confirm.

Items that can be registered

- You can register various functions for shooting. The items that can actually be registered are displayed on the menu of the camera.
- Aperture (F number)
- Shutter speed

To change registered settings

Change the setting to the desired one and re-register the setting to the same mode number.

Note

- M1 through M4 can be selected only when a memory card is inserted into the product.
- Program Shift cannot be registered.

Related Topic

- [Recall \(Camera Settings1/Camera Settings2\)](#)

Interchangeable Lens Digital Camera
ILCE-6100 α6100

Dial/Wheel Setup



You can switch the functions of the control dial and the control wheel.

1 MENU →  2 (Camera Settings2) → [Dial/Wheel Setup] → desired setting.

Menu item details

 SS  F/no.:

You can change the shutter speed using the control wheel, and change the aperture value using the control dial.

 F/no.  SS:

You can change the aperture value using the control wheel, and change the shutter speed using the control dial.

Note

- [Dial/Wheel Setup] is enabled when the shooting mode is set to "M."

Interchangeable Lens Digital Camera
ILCE-6100 α6100

Dial / Wheel Lock

You can set whether the dial and wheel will be locked by pressing and holding the Fn (Function) button.

1 MENU →  2 (Camera Settings2) → [Dial / Wheel Lock] → desired setting.

Menu item details

Lock:

Locks the control dial and control wheel.

Unlock:

Does not lock the control dial or control wheel even if you press and hold the Fn (Function) button.

Hint

- You can release the lock by holding the Fn (Function) button down again.

Add Item

You can register the desired menu items to ★ (My Menu) under MENU.

- 1 MENU → ★ (My Menu) → [Add Item].
- 2 Select an item that you want to add to ★ (My Menu) using the top/bottom/left/right sides of the control wheel.
- 3 Select a destination using the top/bottom/left/right sides of the control wheel.

Hint

- You can add up to 30 items to ★ (My Menu).

Note

- You cannot add the following items to ★ (My Menu).
 - Any item under MENU →  (Playback)
 - [View on TV]

Related Topic

- [Sort Item](#)
- [Delete Item](#)
- [Using MENU items](#)

Interchangeable Lens Digital Camera
ILCE-6100 α6100

Sort Item

You can rearrange the menu items added to ★ (My Menu) under MENU.

- 1 MENU → ★ (My Menu) → [Sort Item].
 - 2 Select an item that you want to move using the top/bottom/left/right sides of the control wheel.
 - 3 Select a destination using the top/bottom/left/right sides of the control wheel.
-

Related Topic

- [Add Item](#)

Delete Item

You can delete menu items added to ★ (My Menu) of MENU.

1 MENU → ★ (My Menu) → [Delete Item].

2 Select an item that you want to delete using the top/bottom/left/right sides of the control wheel, and then press the center to delete the selected item.

Hint

- To delete all the items on a page, select MENU → ★ (My Menu) → [Delete Page].
- You can delete all the items added to ★ (My Menu) by selecting MENU → ★ (My Menu) → [Delete All].

Related Topic

- [Delete Page](#)
- [Delete All](#)
- [Add Item](#)

Interchangeable Lens Digital Camera
ILCE-6100 α6100

Delete Page

You can delete all the menu items added to a page under ★ (My Menu) in MENU.

1 MENU → ★ (My Menu) → [Delete Page].

2 Select a page that you want to delete using the left/right sides of the control wheel, and then press the center of the control wheel to delete the items.

Related Topic

- [Add Item](#)
- [Delete All](#)

Interchangeable Lens Digital Camera
ILCE-6100 α6100

Delete All

You can delete all the menu items added to ★ (My Menu) in MENU.

- 1 MENU → ★ (My Menu) → [Delete All].
 - 2 Select [OK].
-

Related Topic

- [Add Item](#)
- [Delete Page](#)

Interchangeable Lens Digital Camera
ILCE-6100 α6100

Auto Review

You can check the recorded image on the screen right after the shooting. You can also set the display time for Auto Review.

① MENU →  2 (Camera Settings2) → [Auto Review] → desired setting.

Menu item details

10 Sec/5 Sec/2 Sec:

Displays the recorded image on the screen right after shooting for the selected duration of time. If you perform a magnifying operation during Auto Review, you can check that image using the magnified scale.

Off:

Does not display the Auto Review.

Note

- When you use a function that performs image processing, the image before processing may be displayed temporarily, followed by the image after processing.
- The DISP (Display Setting) settings are applied for the Auto Review display.



Related Topic

- [Enlarging an image being played back \(Enlarge Image\)](#)

Interchangeable Lens Digital Camera
ILCE-6100 α6100

Aperture Preview

While you press and hold the key to which you assigned the [Aperture Preview] function, the aperture is stepped down to the set aperture value and you can check the blurriness prior to shooting.

- 1 MENU →  2 (Camera Settings2) → [ Custom Key] → set the [Aperture Preview] function to the desired key.
- 2 Confirm the image by pressing the key to which [Aperture Preview] was assigned.

Hint



- Although you can change the aperture value during the preview, the subject may be defocused if you select a brighter aperture. We recommend that you adjust the focus again.

Related Topic

- [Assigning frequently used functions to buttons \(Custom Key\)](#)
- [Shot. Result Preview](#)

Shot. Result Preview

While pressing down the key to which [Shot. Result Preview] is assigned, you can check the image preview with the DRO, shutter speed, aperture and ISO sensitivity settings applied. Check the shooting result preview before shooting.

- 1 MENU →  2 (Camera Settings2) → [ Custom Key] → set the [Shot. Result Preview] function to the desired key.
- 2 Confirm the image by pressing the key to which [Shot. Result Preview] was assigned.

Hint

- The DRO settings, shutter speed, aperture and ISO sensitivity settings you have set are reflected on the image for [Shot. Result Preview], but some effects cannot be previewed depending on the shooting settings. Even in that case, the settings you have selected will be applied to the images you shoot.

Related Topic

- [Assigning frequently used functions to buttons \(Custom Key\)](#)
- [Aperture Preview](#)

Live View Display

Sets whether or not to show images altered with effects of the exposure compensation, white balance, [Creative Style], or [Picture Effect] on the screen.

1 MENU →  2 (Camera Settings2) → [Live View Display] → desired setting.

Menu item details

Setting Effect ON:

Displays Live View in conditions close to what your picture will look like as a result of applying all your settings. This setting is useful when you want to shoot pictures while checking the results of the shot on the Live View screen.

Setting Effect OFF:

Displays Live View without the effects of exposure compensation, white balance, [Creative Style], or [Picture Effect]. When this setting is used, you can easily check the image composition.

Live View is always displayed with the appropriate brightness even in [Manual Exposure] mode.

When [Setting Effect OFF] is selected, the **VIEW** icon is displayed on the Live View screen.

Hint

- When you use a third-party flash, such as a studio flash, Live View Display may be dark for some shutter speed settings. When [Live View Display] is set to [Setting Effect OFF], Live View Display will be displayed brightly, so that you can easily check the composition.

Note

- [Live View Display] cannot be set to [Setting Effect OFF] in the following shooting modes:
 - [Intelligent Auto]
 - [Superior Auto]
 - [Sweep Panorama]
 - [Movie]
 - [S&Q Motion]
 - [Scene Selection]
- When [Live View Display] is set to [Setting Effect OFF], the brightness of the shot image will not be the same as that of the displayed Live View.

Interchangeable Lens Digital Camera
ILCE-6100 α6100

Grid Line

Sets whether the grid line is displayed or not. The grid line will help you to adjust the composition of images.

1 MENU →  2 (Camera Settings2) → [Grid Line] → desired setting.

Menu item details

Rule of 3rds Grid:

Place main subjects close to one of the grid lines that divide the image into thirds for a well-balanced composition.

Square Grid:

Square grids make it easier to confirm the horizontal level of your composition. This is useful for assessing the composition when shooting landscapes, closeups, or when performing camera scanning.

Diag. + Square Grid:

Place a subject on the diagonal line to express an uplifting and powerful feeling.

Off:

Does not display the grid line.

Interchangeable Lens Digital Camera
ILCE-6100 α6100

FINDER/MONITOR

Sets the method for switching the display between the viewfinder and the monitor.

1 MENU →  (Camera Settings2) → [FINDER/MONITOR] → desired setting.

Menu item details

Auto:

When you look into the viewfinder, the eye sensor reacts and the display is switched to the viewfinder automatically.





Viewfinder(Manual):

The monitor is turned off and the image is displayed only in the viewfinder.

Monitor(Manual):

The viewfinder is turned off and the image is always displayed on the monitor.

Hint

- You can assign the [FINDER/MONITOR] function to your preferred key.
MENU →  (Camera Settings2) → [ Custom Key], [ Custom Key] or [ Custom Key] → set [Finder/Monitor Sel.] to the preferred key.
- If you want to retain the viewfinder display or the monitor display, set [FINDER/MONITOR] to [Viewfinder(Manual)] or [Monitor(Manual)] beforehand.
You can keep the monitor off when you take your eyes off the viewfinder during recording by setting the monitor display to [Monitor Off] using the DISP button. Select MENU →  (Camera Settings2) → [DISP Button] → [Monitor] and add a check mark to [Monitor Off] beforehand.

Related Topic

- [Assigning frequently used functions to buttons \(Custom Key\)](#)
- [DISP Button \(Monitor/Finder\)](#)

Interchangeable Lens Digital Camera
ILCE-6100 α6100

Monitor Brightness

Adjust the brightness of the screen.

1 MENU →  (Setup) → [Monitor Brightness] → desired setting.

Menu item details

Manual:

Adjusts the brightness within the range of -2 to +2.

Sunny Weather:

Sets the brightness appropriately for shooting outdoors.

Note

- The [Sunny Weather] setting is too bright for shooting indoors. Set [Monitor Brightness] to [Manual] for indoor shooting.

Interchangeable Lens Digital Camera
ILCE-6100 α6100

Viewfinder Bright.

When using the viewfinder, this product adjusts the brightness of the viewfinder according to the surrounding environment.

① **MENU** →  (**Setup**) → [**Viewfinder Bright.**] → **desired setting.**

Menu item details

Auto:

Adjusts the brightness automatically.

Manual:

Selects the brightness of the viewfinder within the range of -2 to +2.

Interchangeable Lens Digital Camera
ILCE-6100 α6100

Finder Color Temp.

Adjusts the color temperature of the electronic viewfinder.

1 MENU →  (Setup) → [Finder Color Temp.] → desired setting.

Menu item details

-2 to +2:

When you select “-,” the viewfinder screen changes to a warmer color, and when you select “+,” it changes to a colder color.

Interchangeable Lens Digital Camera
ILCE-6100 α6100

Display Quality

You can change the display quality.

1 MENU →  (Setup) → [Display Quality] → desired setting.

Menu item details

High:

Displays in high quality.

Standard:



Displays in standard quality.

Note

- When [High] is set, battery consumption will be higher than when [Standard] is set.
- When the temperature of the camera rises, the setting may become locked to [Standard].

Bright Monitoring

Allows you to adjust the composition when shooting in dark environments. By extending the exposure time, you can check the composition on the viewfinder/monitor even in dark locations such as under the night sky.

- 1 **MENU** →  **2 (Camera Settings2)** → [ **Custom Key**] → assign the **[Bright Monitoring]** function to the desired key.
- 2 **Press the key to which you assigned the [Bright Monitoring] function, then shoot an image.**
 - The brightness due to [Bright Monitoring] will continue after shooting.
 - To return the monitor brightness to normal, press the key to which you assigned the [Bright Monitoring] function once again.

Note

- During [Bright Monitoring], [Live View Display] will automatically switch to [Setting Effect OFF], and setting values such as exposure compensation will not be reflected in the live view display. It is recommended that you use [Bright Monitoring] only in dark locations.
- [Bright Monitoring] will be automatically cancelled in the following situations.
 - When the camera is turned off.
 - When the shooting mode is changed from P/A/S/M to a mode that is not P/A/S/M.
 - When the focus mode is set to other than manual focus.
 - When [ MF Assist] is executed.
 - When [Focus Magnifier] is selected.
- During [Bright Monitoring], the shutter speed may be slower than normal while shooting in dark locations. Also, because the measured brightness range is expanded, the exposure may change.

Related Topic

- [Live View Display](#)

Interchangeable Lens Digital Camera
ILCE-6100 α6100

Format

When you use a memory card with this camera for the first time, we recommend that you format the card using the camera for stable performance of the memory card. Note that formatting permanently erases all data on the memory card, and is unrecoverable. Save valuable data on a computer, etc.

1 MENU →  (Setup) → [Format].

Note

- Formatting permanently erases all data including protected images and registered settings (from M1 to M4).
- The access lamp lights up during formatting. Do not remove the memory card while the access lamp is lit up.
- Format the memory card on this camera. If you format the memory card on the computer, the memory card may not be usable depending on the format type.
- It may take a few minutes to complete formatting, depending on the memory card.
- You cannot format the memory card if the remaining battery charge is less than 1%.

Interchangeable Lens Digital Camera
ILCE-6100 α6100

File Number

Selects how to assign file numbers to still images.

① MENU →  (Setup) → [File Number] → **desired setting.**

Menu item details

Series:

The product will assign numbers to files sequentially up to "9999" without resetting.

Reset :

The product resets numbers when a file is recorded in a new folder and assigns numbers to files starting with "0001".
(When the recording folder contains a file, a number one higher than the largest number is assigned.)

Interchangeable Lens Digital Camera
ILCE-6100 α6100

Display Media Info.

Displays the recordable time of movies for the inserted memory card. Also displays the number of recordable still images for the inserted memory card.

① MENU →  (Setup) → [Display Media Info.].

Interchangeable Lens Digital Camera
ILCE-6100 α6100

Select REC Folder

If [Folder Name] is set to [Standard Form] and there are 2 folders or more, you can select the folder on the memory card to which images are to be recorded.

① MENU →  (Setup) → [Select REC Folder] → desired folder.

Note

- You cannot select the folder when [Folder Name] is set to [Date Form].

Related Topic

- [Folder Name](#)

Interchangeable Lens Digital Camera
ILCE-6100 α6100

New Folder

Creates a new folder on the memory card for recording still images. A new folder is created with a folder number one greater than the largest folder number currently used. Images are recorded in the newly created folder.

① MENU →  (Setup) → [New Folder].

Note

- When you insert a memory card that was used with other equipment into this product and shoot images, a new folder may be automatically created.
- Up to 4,000 images in total can be stored in one folder. When the folder capacity is exceeded, a new folder may be automatically created.

Interchangeable Lens Digital Camera
ILCE-6100 α6100

Folder Name

Still images are recorded in a folder that is automatically created inside the DCIM folder on the memory card. You can change the way folder names are assigned.

① MENU →  (Setup) → [Folder Name] → desired setting.

Menu item details

Standard Form:

The folder name form is as follows: folder number + MSDCF.

Example: 100MSDCF

Date Form:

The folder name form is as follows: folder number + Y (the last digit)/MM/DD.

Example: 10090405(Folder number: 100, date: 04/05/2019)

Note

- You cannot change the [Folder Name] settings for movies.

Recover Image DB

If image files were processed on a computer, problems may occur in the image database file. In such cases, the images on the memory card will not be played back on this product. If these problems happen, repair the file using [Recover Image DB].

① MENU →  (Setup) → [Recover Image DB] → [Enter].

Note

- If the battery pack is extremely depleted, image database files cannot be repaired. Use a sufficiently charged battery pack.
- Images recorded on the memory card are not deleted by [Recover Image DB].

Interchangeable Lens Digital Camera
ILCE-6100 α6100

Audio signals

Selects whether the product produces a sound or not.

1 MENU →  2 (Camera Settings2) → [Audio signals] → desired setting.

Menu item details

On:

Sounds are produced for example when the focus is achieved by pressing the shutter button halfway down.

Off:

Sounds are not produced.

Note

- If [Focus Mode] is set to [Continuous AF], the camera will not beep when it focuses on a subject.

Interchangeable Lens Digital Camera
ILCE-6100 α6100

Tile Menu

Selects whether to always display the first screen of the menu when you press the MENU button.

① MENU →  (Setup) → [Tile Menu] → desired setting.

Menu item details

On:

Always displays the first screen of the menu (Tile Menu).

Off:

Deactivates the Tile Menu display.

Interchangeable Lens Digital Camera
ILCE-6100 α6100

Mode Dial Guide

You can display the description of a shooting mode when you turn the mode dial and change the settings available for that shooting mode.

① **MENU** →  (Setup) → **[Mode Dial Guide]** → **desired setting.**

Menu item details

On:

Displays the Mode Dial Guide.

Off:

Does not display the Mode Dial Guide.

Interchangeable Lens Digital Camera
ILCE-6100 α6100

Power Save Start Time

Sets time intervals to automatically switch to power save mode when you are not performing operations to prevent wearing down the battery pack. To return to shooting mode, perform an operation such as pressing the shutter button halfway down.

1 MENU →  (Setup) → [Power Save Start Time] → desired setting.

Menu item details

30 Min/5 Min/2 Min/1 Min/10 Sec

Note

- Turn off the product when you do not use it for a long time.
- The power save function is deactivated in the following situations:
 - While power is being supplied via USB
 - While playing back slideshows
 - While recording movies
 - While connected to a computer or TV
 - When [Bluetooth Rmt Ctrl] is set to [On]

Interchangeable Lens Digital Camera
ILCE-6100 α6100

Auto Power OFF Temp.

Sets the temperature of the camera at which the camera turns off automatically during shooting. When it is set to [High], you can continue shooting even when the temperature of the camera gets hotter than normal.

1 MENU →  (Setup) → [Auto Power OFF Temp.] → desired setting.

Menu item details

Standard:

Sets the standard temperature for the camera to turn off.

High:

Sets the temperature at which the camera turns off to higher than [Standard].

Notes when [Auto Power OFF Temp.] is set to [High]

- Do not shoot while holding the camera in your hand. Use a tripod.
- Using the camera while holding it in your hand for a long period of time may cause low-temperature burns.

Continuous recording time for movies when [Auto Power OFF Temp.] is set to [High]

The duration of time available for continuous movie recording is as follows when the camera starts recording with the default settings after the power has been turned off for a while. The following values indicate the continuous time from when the camera starts recording until the camera stops recording.

Ambient temperature: 20°C (68°F)

Continuous recording time for movies (HD): Approx. 30 minutes

Continuous recording time for movies (4K): Approx. 30 minutes

Ambient temperature: 30°C (86°F)

Continuous recording time for movies (HD): Approx. 30 minutes

Continuous recording time for movies (4K): Approx. 30 minutes

Ambient temperature: 40°C (104°F)

Continuous recording time for movies (HD): Approx. 30 minutes

Continuous recording time for movies (4K): Approx. 30 minutes

HD: XAVC S HD (60p 50M/50p 50M, when the camera is not connected via Wi-Fi)

4K: XAVC S 4K (24p 60M/25p 60M, when the camera is not connected via Wi-Fi)

Note

- Even if [Auto Power OFF Temp.] is set to [High], depending on the conditions or the temperature of the camera, the recordable time for movies may not change.

Related Topic

- [Recordable movie times](#)

Interchangeable Lens Digital Camera
ILCE-6100 α6100

NTSC/PAL Selector

Plays back movies recorded with the product on a NTSC/PAL system TV.

1 MENU →  (Setup) → [NTSC/PAL Selector] → [Enter]

Note

- If you insert a memory card that has previously been formatted with a different video system, a message telling you that you must reformat the card will appear.
If you want to record using another system, re-format the memory card or use another memory card.
- When you perform [NTSC/PAL Selector], and the setting is changed from the default one, a message "Running on NTSC." or "Running on PAL." will appear on the start-up screen.

Interchangeable Lens Digital Camera
ILCE-6100 α6100

HDMI Settings: HDMI Resolution

When you connect the product to a High Definition (HD) TV with HDMI terminals using an HDMI cable (sold separately), you can select HDMI Resolution to output images to the TV.

① MENU →  (Setup) → [HDMI Settings] → [HDMI Resolution] → desired setting.

Menu item details

Auto:

The product automatically recognizes an HD TV and sets the output resolution.

2160p/1080p:

Outputs signals in 2160p/1080p.

1080p:

Outputs signals in HD picture quality (1080p).

1080i:





Outputs signals in HD picture quality (1080i).

Note

- If the images are not displayed properly using the [Auto] setting, select either [1080i], [1080p] or [2160p/1080p], based on which TV is to be connected.

Interchangeable Lens Digital Camera
ILCE-6100 α6100

HDMI Settings: 24p/60p Output (movie) (Only for 1080 60i compatible models)

You can set 1080/24p or 1080/60p as the HDMI output format when [ Record Setting] is set to [24p 50M ], [24p 60M ] or [24p 100M ].

1 MENU →  (Setup) → [HDMI Settings] → [HDMI Resolution] → [1080p] or [2160p/1080p].

2 MENU →  (Setup) → [HDMI Settings] → [ 24p/60p Output] → desired setting.

Menu item details

60p:

Movies are output as 60p.

24p:

Movies are output as 24p.

Note

- Steps 1 and 2 can be set in either order.

Related Topic

- [Record Setting \(movie\)](#)

Interchangeable Lens Digital Camera
ILCE-6100 α6100

HDMI Settings: HDMI Info. Display

Selects whether to display the shooting information when this product and the TV are connected using an HDMI cable (sold separately).

1 MENU →  (Setup) → [HDMI Settings] → [HDMI Info. Display] → desired setting.

Menu item details

On:

Displays the shooting information on the TV.

The recorded image and the shooting information are displayed on the TV, while nothing is displayed on the camera's monitor.

Off:

Does not display the shooting information on the TV.

Only the recorded image is displayed on the TV, while the recorded image and the shooting information are displayed on the camera's monitor.

Note

- When the camera is connected to an HDMI device while [ File Format] is set to [XAVC S 4K], the setting switches to [Off].

Interchangeable Lens Digital Camera
ILCE-6100 α6100

HDMI Settings: CTRL FOR HDMI

When connecting this product to a “BRAVIA” Sync-compatible TV using an HDMI cable (sold separately), you can operate this product by aiming the TV remote control at the TV.

- 1 MENU →  (Setup) → [HDMI Settings] → [CTRL FOR HDMI] → desired setting.**
- 2 Connect this product to a “BRAVIA” Sync-compatible TV.**

The input of the TV is switched automatically and images on this product are displayed on the TV screen.
- 3 Press the SYNC MENU button of the TV’s remote control.**
- 4 Operate this product using the TV’s remote control.**

Menu item details

On:

You can operate this product with a TV’s remote control.

Off:

You cannot operate this product with a TV’s remote control.

Note

- If you connect this product to a TV using an HDMI cable, available menu items are limited.
- [CTRL FOR HDMI] is available only with a “BRAVIA” Sync-compatible TV. Also, the SYNC MENU operation differs depending on the TV you are using. For details, refer to the operating instructions supplied with the TV.
- If the product performs unwanted operations in response to the TV remote control when the product is connected to another manufacturer’s TV using an HDMI connection, select MENU →  (Setup) → [HDMI Settings] → [CTRL FOR HDMI] → [Off].

Interchangeable Lens Digital Camera
ILCE-6100 α6100

USB Connection

Selects the USB connection method when this product is connected to a computer, etc.

Select MENU →  (Network) → [Ctrl w/ Smartphone] → [Ctrl w/ Smartphone] → [Off] beforehand.

1 MENU →  (Setup) → [USB Connection] → **desired setting.**

Menu item details

Auto:

Establishes a Mass Storage or MTP connection automatically, depending on the computer or other USB devices to be connected. Windows 7, Windows 8.1, or Windows 10 computers are connected in MTP, and their unique functions are enabled for use.

Mass Storage:

Establishes a Mass Storage connection between this product, a computer, and other USB devices.

MTP:

Establishes an MTP connection between this product, a computer, and other USB devices. Windows 7, Windows 8.1, or Windows 10 computers are connected in MTP, and their unique functions are enabled for use.

PC Remote:

Uses Imaging Edge (Remote) to control the product from a computer, including such functions as shooting and storing images on the computer.

Note

- It may take some time to make the connection between this product and a computer when [USB Connection] is set to [Auto].

Related Topic

- [PC Remote Settings: Still Img. Save Dest.](#)
- [PC Remote Settings: RAW+J PC Save Img](#)

Interchangeable Lens Digital Camera
ILCE-6100 α6100

USB LUN Setting

Enhances compatibility by limiting of USB connection functions.

1 MENU →  (Setup) → [USB LUN Setting] → desired setting.

Menu item details

Multi:

Normally, use [Multi].

Single:

Set [USB LUN Setting] to [Single] only if you cannot make a connection.

Interchangeable Lens Digital Camera
ILCE-6100 α6100

USB Power Supply

Sets whether to supply power via the micro USB cable when the product is connected to a computer or an USB device.

1 MENU →  (Setup) → [USB Power Supply] → desired setting.

Menu item details

- On:**
Power is supplied to the product via a micro USB cable when the product is connected to a computer, etc.
- Off:**
Power is not supplied to the product via a micro USB cable when the product is connected to a computer, etc. If you use the supplied AC Adaptor, power will be supplied even when [Off] is selected.

Operations available while supplying power via a USB cable

The following table shows you which operations are available/unavailable while supplying power via a USB cable. A checkmark indicates that the operation is available, and “—” indicates that the operation is unavailable.

Operation	Available / Unavailable
Shooting images	✓
Playing back images	✓
Wi-Fi/NFC/Bluetooth connections	✓
Charging a battery pack	—
Turning the camera on without a battery pack inserted	—

Note

- Insert the battery pack into the product to supply power via USB cable.

Interchangeable Lens Digital Camera
ILCE-6100 α6100

PC Remote Settings: Still Img. Save Dest.

Sets whether to save still images stored in both the camera and the computer during PC Remote shooting. This setting is useful when you want to check recorded images on the camera without leaving the camera.

* PC Remote: Uses Imaging Edge (Remote) to control the product from a computer, including such functions as shooting and storing images on the computer.

1 **MENU** →  (Setup) → **[PC Remote Settings]** → **[Still Img. Save Dest.]** → **desired setting.**

Menu item details

PC Only:

Saves still images only on the computer.

PC+Camera:

Saves still images on the computer and the camera.

Note

- You cannot change the [Still Img. Save Dest.] setting during PC Remote shooting. Configure the setting before you start shooting.
- If you insert a memory card that is not recordable, you cannot shoot still images even if you select [PC+Camera].
- If you select [PC+Camera] and you have not inserted a memory card into the camera, you cannot release the shutter even if [Release w/o Card] is set to [Enable].
- While you are playing back still images on the camera, you cannot shoot using PC Remote.

Related Topic

- [USB Connection](#)
- [Release w/o Card](#)
- [PC Remote Settings: RAW+J PC Save Img](#)

Interchangeable Lens Digital Camera
ILCE-6100 α6100

PC Remote Settings: RAW+J PC Save Img

Selects the file type for images to be transferred to the computer in PC Remote shooting.

When shooting still images using PC Remote, the application on the computer does not display the image until the image has been completely transferred. When performing RAW+JPEG shooting, you can accelerate the display processing speed by transferring only JPEG images instead of transferring both RAW and JPEG images.

* PC Remote: Uses Imaging Edge (Remote) to control the product from a computer, including such functions as shooting and storing images on the computer.

1 **MENU** →  (Setup) → [PC Remote Settings] → [RAW+J PC Save Img] → desired setting.

Menu item details

RAW & JPEG:

Transfers both RAW and JPEG files to the computer.

JPEG Only:

Transfers only JPEG files to the computer.

RAW Only:

Transfers only RAW files to the computer.

Note

- You cannot change the [RAW+J PC Save Img] setting during PC Remote shooting. Configure the setting before you start shooting.
- [RAW+J PC Save Img] can be set only when [ File Format] is set to [RAW & JPEG].

Related Topic

- [USB Connection](#)
- [File Format \(still image\)](#)
- [PC Remote Settings: Still Img. Save Dest.](#)

Interchangeable Lens Digital Camera
ILCE-6100 α6100

Language

Selects the language to be used in the menu items, warnings and messages.

1 MENU →  (Setup) → [ Language] → **desired language.**

Interchangeable Lens Digital Camera
ILCE-6100 α6100

Date/Time Setup

The Clock Set screen is displayed automatically when you turn on this product for the first time or when the internal rechargeable backup battery has fully discharged. Select this menu when setting the date and time after the first time.

1 MENU →  (Setup) → [Date/Time Setup] → desired setting.

Menu item details

Daylight Savings:

Selects Daylight Savings [On]/[Off].

Date/Time:

Sets the date and time.

Date Format:

Selects the date and time display format.

Hint

- To charge the internal rechargeable backup battery, insert a charged battery pack, and leave the product for 24 hours or more with the power off.
- If the clock resets every time the battery is charged, the internal rechargeable backup battery may be worn out. Consult your service facility.

Interchangeable Lens Digital Camera
ILCE-6100 α6100

Area Setting

Sets the area where you are using the product.

1 MENU →  (Setup) → [Area Setting] → desired area.

Interchangeable Lens Digital Camera
ILCE-6100 α6100

Version

Displays the version of this product's software. Check the version when updates for this product's software are released, etc.

Also displays the version of the lens if a lens compatible with firmware updates is attached.

The version of the Mount Adaptor is displayed in the lens area if a Mount Adaptor compatible with firmware updates is attached.

① MENU →  (Setup) → [Version].

Note

- Updating can be performed only when the battery level is  (3 remaining battery bars) or more. The use of a sufficiently charged battery or the AC Adaptor (sold separately) is recommended.

Interchangeable Lens Digital Camera
ILCE-6100 α6100

Demo Mode

The [Demo Mode] function displays the movies recorded on the memory card automatically (demonstration), when the camera has not been operated for a certain time. Normally select [Off].

① MENU →  (Setup) → [Demo Mode] → desired setting.

Menu item details

On:

The movie playback demonstration starts automatically if the product is not operated for about one minute. Only protected AVCHD movies can be played back.

Set the view mode to [AVCHD View], and protect the movie file with the oldest recorded date and time.

Off:

Does not show the demonstration.

Note

- You can set this item only when the product is powered by the AC Adaptor (supplied).
- When there is no protected AVCHD movies on the memory card, you cannot select [On].

Interchangeable Lens Digital Camera
ILCE-6100 α6100

Setting Reset

Resets the product to the default settings. Even if you perform [Setting Reset], the recorded images are retained.

① MENU →  (Setup) → [Setting Reset] → desired setting.

Menu item details

Camera Settings Reset:

Initializes the main shooting settings to the default settings.

Initialize:

Initializes all the settings to the default settings.

Note

- Be sure not to eject the battery pack while resetting.
- The value set with [AF Micro Adj.] will not be reset even when [Camera Settings Reset] or [Initialize] is performed.

Related Topic

- [AF Micro Adj.](#)

Interchangeable Lens Digital Camera
ILCE-6100 α6100

Imaging Edge Mobile

Using the smartphone application Imaging Edge Mobile, you can shoot an image while controlling the camera using a smartphone or transfer the images recorded on the camera to the smartphone. Download and install the application Imaging Edge Mobile from your smartphone's application store. If Imaging Edge Mobile is already installed on your smartphone, be sure to update it to the latest version.

For details on Imaging Edge Mobile, refer to the support page (<https://www.sony.net/iem/>).

Note

- Depending on future version upgrades, the operational procedures or screen displays are subject to change without notice.

Interchangeable Lens Digital Camera
ILCE-6100 α6100

Ctrl w/ Smartphone

Sets the condition for connecting the camera to a smartphone.

1 MENU →  (Network) → [Ctrl w/ Smartphone] → desired setting.

Menu item details

Ctrl w/ Smartphone:

Sets whether to connect the camera and a smartphone using Wi-Fi. ([On]/[Off])

Connection:

Displays the QR code or SSID used to connect the camera to a smartphone.

Always Connected:

Sets whether to keep the camera connected to a smartphone. If this item is set to [On], once you connect the camera to a smartphone, it will remain connected to the smartphone at all times. If it is set to [Off], the camera will connect to a smartphone only when the connection procedure is performed.

Note

- If [Always Connected] is set to [On], the power consumption will be greater than when it is set to [Off].

Related Topic

- [Controlling the camera using a smartphone \(NFC One-touch remote\)](#)
- [Controlling the camera using an Android smartphone \(QR Code\)](#)
- [Controlling the camera using an Android smartphone \(SSID\)](#)
- [Controlling the camera using an iPhone or iPad \(QR Code\)](#)
- [Controlling the camera using an iPhone or iPad \(SSID\)](#)
- [Send to Smartphone Func.: Send to Smartphone](#)

Interchangeable Lens Digital Camera
ILCE-6100 α6100

Controlling the camera using a smartphone (NFC One-touch remote)

You can connect this product to an NFC-enabled smartphone by touching them together and then operate the product using the smartphone.

Make sure that [Ctrl w/ Smartphone] is set to [On] by selecting MENU →  (Network) → [Ctrl w/ Smartphone].

1 Activate the NFC function of the smartphone.

- On an iPhone/iPad, launch Imaging Edge Mobile, and then select [Scan NFC/QR Code of the Camera] → [Scan NFC of the Camera] to activate the NFC function.

2 Switch this product to shooting mode.

- The NFC function is available only when the  (N-Mark) is displayed on the screen.

3 Keep touching the smartphone to the camera for 1 to 2 seconds.

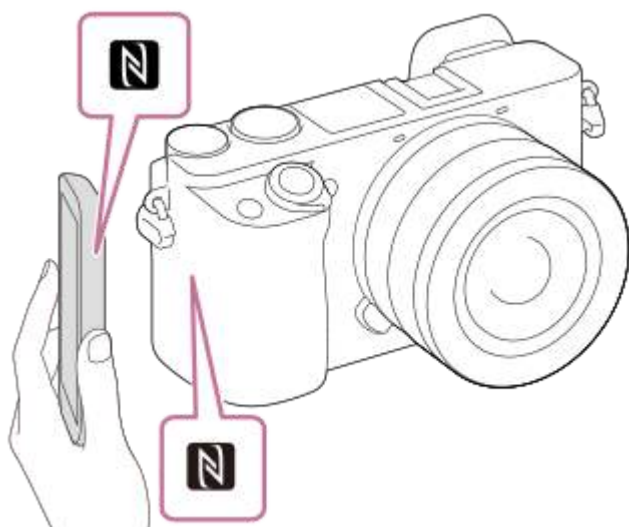

The smartphone and the camera are connected.

- You can shoot an image via remote control while checking the composition of the image on the Imaging Edge Mobile screen.

About “NFC”

NFC is a technology that enables short-range wireless communication between various devices, such as mobile phones or IC tags, etc. NFC makes data communication simpler with just a touch on the designated touch-point.

- NFC (Near Field Communication) is an international standard of short-range wireless communication technology.

Note

- If you cannot make a connection, do as the following:
 - Launch Imaging Edge Mobile on your smartphone, and then move the smartphone slowly toward the  (N-Mark) of this product.
 - If the smartphone is in a case, remove it.

- If the product is in a case, remove it.
- Check whether the NFC function is activated on your smartphone.
- Radio wave interference may occur as Bluetooth communications and Wi-Fi (2.4 GHz) communications use the same frequency band. If your Wi-Fi connection is unstable, it may be improved by turning off the Bluetooth function of the smartphone. If you do this, the location information link function is not available.
- When [Airplane Mode] is set to [On], you cannot connect this product and the smartphone. Set [Airplane Mode] to [Off].
- If this product and the smartphone are connected when the product is in playback mode, the displayed image is sent to the smartphone.

Related Topic

- [Imaging Edge Mobile](#)
- [Airplane Mode](#)

Interchangeable Lens Digital Camera
ILCE-6100 α6100

Controlling the camera using an Android smartphone (QR Code)

You can control this product using your smartphone by connecting your smartphone to the camera using the QR Code. Make sure that [Ctrl w/ Smartphone] is set to [On] by selecting MENU →  (Network) → [Ctrl w/ Smartphone].

1 MENU → (Network) → [Ctrl w/ Smartphone] → [Connection].

QR Code (A) and the SSID (B) are displayed on the monitor of this product.



2 Launch Imaging Edge Mobile on your smartphone and select [Scan QR Code of the Camera].

3 Select [OK] on the smartphone screen.

- When a message is displayed, select [OK] again.

4 Read the QR Code displayed on the monitor of this product with the smartphone.

Once the QR Code has been read, a message [Connect with the camera?] will be displayed on the smartphone screen.

5 Select [OK] on the smartphone screen.

The smartphone is connected to the product.

- You can now shoot images remotely while checking the composition on the smartphone screen.

Hint

- Once the QR Code has been read, this product's SSID (DIRECT-xxxx) and password are registered to the smartphone. This enables you to easily connect the smartphone to the product via Wi-Fi at a later date by selecting the SSID. (Set [Ctrl w/ Smartphone] to [On] in advance.)

Note

- Radio wave interference may occur as Bluetooth communications and Wi-Fi (2.4 GHz) communications use the same frequency band. If your Wi-Fi connection is unstable, it may be improved by turning off the Bluetooth function of the smartphone. If you do this, the location information link function is not available.
- If you cannot connect your smartphone to this product using the [One-touch(NFC)] function or QR Code, use the SSID and password.

Related Topic

- [Imaging Edge Mobile](#)
- [Controlling the camera using an Android smartphone \(SSID\)](#)

5-009-879-12(1) Copyright 2019 Sony Corporation

Interchangeable Lens Digital Camera
ILCE-6100 α6100

Controlling the camera using an Android smartphone (SSID)

You can control this product using your smartphone by connecting your smartphone to the camera using the SSID and password.

Make sure that [Ctrl w/ Smartphone] is set to [On] by selecting MENU →  (Network) → [Ctrl w/ Smartphone].

1 MENU →  (Network) → [Ctrl w/ Smartphone] → [ Connection].

QR Code is displayed on the monitor of this product.

2 Press the  (Delete) button of this product.

This product's SSID and password are displayed on the monitor of this product.



3 Launch Imaging Edge Mobile on your smartphone.

4 Select the model name of this product (DIRECT-xxxx: xxxx).

5 Input the password that is displayed on this product.

The smartphone is connected to the product.

- You can now shoot images remotely while checking the composition on the smartphone screen.

Note

- Radio wave interference may occur as Bluetooth communications and Wi-Fi (2.4 GHz) communications use the same frequency band. If your Wi-Fi connection is unstable, it may be improved by turning off the Bluetooth function of the smartphone. If you do this, the location information link function is not available.

Related Topic

- [Imaging Edge Mobile](#)

Interchangeable Lens Digital Camera
ILCE-6100 α6100

Controlling the camera using an iPhone or iPad (QR Code)

You can connect an iPhone or iPad to the camera using the QR Code and operate the camera using the iPhone or iPad. Make sure that [Ctrl w/ Smartphone] is set to [On] by selecting MENU →  (Network) → [Ctrl w/ Smartphone].

- 1 MENU →  (Network) → [Ctrl w/ Smartphone] → [ Connection].

QR Code (A) and the SSID (B) are displayed on the monitor of this product.

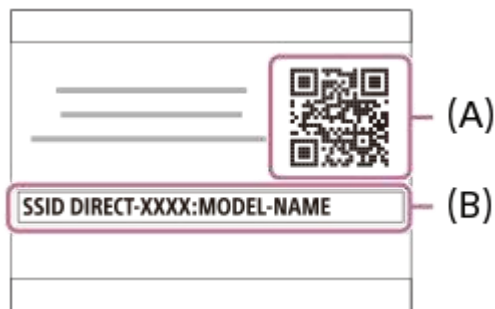

- 2 Launch Imaging Edge Mobile on your iPhone or iPad and select [Scan QR Code of the Camera].

- 3 Select [OK] on the iPhone or iPad screen.

- When a message is displayed, select [OK] again.

- 4 Read the QR Code displayed on the monitor of this product with the iPhone or iPad.

The iPhone or iPad will connect to the product.

- You can now shoot images remotely while checking the composition on the screen of your iPhone or iPad.

Hint

- Once the QR Code has been read, this product's SSID (DIRECT-xxxx) and password are registered to the iPhone or iPad. This enables you to easily connect the iPhone or iPad to the product via Wi-Fi at a later date by selecting the SSID. (Set [Ctrl w/ Smartphone] to [On] in advance.)

Note

- Radio wave interference may occur as Bluetooth communications and Wi-Fi (2.4 GHz) communications use the same frequency band. If your Wi-Fi connection is unstable, it may be improved by turning off the Bluetooth function of the smartphone. If you do this, the location information link function is not available.
- If you cannot connect your iPhone or iPad to this product using the QR Code, use the SSID and password.

Related Topic

- [Imaging Edge Mobile](#)
- [Controlling the camera using an iPhone or iPad \(SSID\)](#)

Interchangeable Lens Digital Camera
ILCE-6100 α6100

Controlling the camera using an iPhone or iPad (SSID)

You can control the camera using an iPhone or iPad by connecting the iPhone or iPad to the camera using the SSID and password.

Make sure that [Ctrl w/ Smartphone] is set to [On] by selecting MENU →  (Network) → [Ctrl w/ Smartphone].

- 1 MENU →  (Network) → [Ctrl w/ Smartphone] → [ Connection].

QR Code is displayed on the monitor of this product.

- 2 Press the  (Delete) button of this product.

This product's SSID and password are displayed on the monitor of this product.



- 3 Select the model name of this product (DIRECT-xxxx: xxxx) on the Wi-Fi setting screen of your iPhone or iPad.



- 4 Input the password that is displayed on this product.

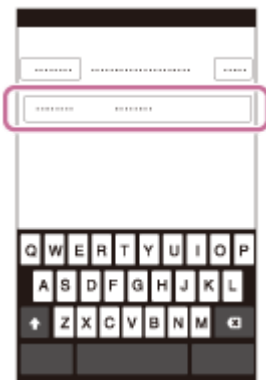

The iPhone or iPad is connected to the product.

5 Confirm that your iPhone or iPad was connected to the “SSID” shown on this product.



6 Return to the "Home" screen of the iPhone or iPad and launch Imaging Edge Mobile.

- You can now shoot images remotely while checking the composition on the screen of your iPhone or iPad.

Note

- Radio wave interference may occur as Bluetooth communications and Wi-Fi (2.4 GHz) communications use the same frequency band. If your Wi-Fi connection is unstable, it may be improved by turning off the Bluetooth function of the smartphone. If you do this, the location information link function is not available.

Related Topic

- [Imaging Edge Mobile](#)

Interchangeable Lens Digital Camera
ILCE-6100 α6100

Send to Smartphone Func.: Send to Smartphone

You can transfer still images, XAVC S movies, slow-motion movies, or quick-motion movies to a smartphone and view them. The application Imaging Edge Mobile must be installed on your smartphone.

1 MENU → **🌐 (Network)** → **[Send to Smartphone Func.]** → **[Send to Smartphone]** → **desired setting**.

- If you press the  (Send to Smartphone) button in playback mode, the setting screen for [Send to Smartphone] will appear.

2 If the product is ready for the transfer, the information screen appears on the product. Connect the smartphone and the product using that information.

- The setting method for connecting the smartphone and the product varies depending on the smartphone.



Menu item details

Select on This Device:

Selects an image on the product to be transferred to the smartphone.

(1) Select from among [This Image], [All with this date] or [Multiple Images].

- The options displayed may differ depending on the View Mode selected on the camera.

(2) If you select [Multiple Images], select the desired images using the center of the control wheel, then press MENU → [Enter].

Select on Smartphone:

Displays all images recorded on the product's memory card on the smartphone.

Note

- You can only transfer images that are saved on the camera's memory card.
- You can select an image size to be sent to the smartphone from [Original], [2M] or [VGA]. To change the image size, refer to the following steps.
 - For Android smartphone
Start Imaging Edge Mobile, and change the image size by [Settings] → [Copy Image Size].
 - For iPhone/iPad
Select Imaging Edge Mobile in the setting menu, and change the image size by [Copy Image Size].
- RAW images are converted to JPEG format when they are sent.
- You cannot send AVCHD format movies.

- Depending on the smartphone, the transferred movie may not be played back correctly. For example, the movie may not play smoothly, or there may be no sound.
- Depending on the format of the still image, movie, slow-motion movie, or quick-motion movie, it may not be possible to play it back on a smartphone.
- This product shares the connection information for [Send to Smartphone] with a device that has permission to connect. If you want to change the device that is permitted to connect to the product, reset the connection information by following these steps. MENU →  (Network) → [Wi-Fi Settings] → [SSID/PW Reset]. After resetting the connection information, you must register the smartphone again.
- When [Airplane Mode] is set to [On], you cannot connect this product and the smartphone. Set [Airplane Mode] to [Off].
- While you transfer many images or long movies, we recommend that you supply power to the camera from a wall outlet (wall socket) using the AC Adaptor (supplied).

Related Topic

- [Imaging Edge Mobile](#)
- [Controlling the camera using a smartphone \(NFC One-touch remote\)](#)
- [Controlling the camera using an Android smartphone \(QR Code\)](#)
- [Controlling the camera using an Android smartphone \(SSID\)](#)
- [Controlling the camera using an iPhone or iPad \(QR Code\)](#)
- [Controlling the camera using an iPhone or iPad \(SSID\)](#)
- [Sending images to a smartphone \(NFC One-touch Sharing\)](#)
- [Send to Smartphone Func.: Sending Target \(proxy movies\)](#)
- [Airplane Mode](#)

Send to Smartphone Func.: Sending Target (proxy movies)

When transferring XAVC S video to a smartphone with [Send to Smartphone], you can set whether to transfer the low-bit-rate proxy movie or the high-bit-rate original movie.

1 MENU →  (Network) → [Send to Smartphone Func.] → [**Px** Sending Target] → desired setting.

Menu item details

Proxy Only:

Transfers only proxy movies.

Original Only:

Transfers only original movies.

Proxy & Original:

Transfers both proxy and original movies.

Note

- While you transfer many images or long movies, we recommend that you supply power to the camera from a wall outlet (wall socket) using the AC Adaptor (supplied).

Related Topic

- [Send to Smartphone Func.: Send to Smartphone](#)
- [Proxy Recording](#)

Sending images to a smartphone (NFC One-touch Sharing)

With just one touch, you can connect this product and an NFC-enabled smartphone, and send an image displayed on the product screen directly to the smartphone. You can transfer still images, XAVC S movies and slow-motion and quick-motion movies.

- 1 Activate the NFC function of the smartphone.**
 - On an iPhone/iPad, launch Imaging Edge Mobile, and then select [Scan NFC/QR Code of the Camera] → [Scan NFC of the Camera] to activate the NFC function.
- 2 Display a single image on the product.**
- 3 Keep touching the smartphone to the camera for 1 to 2 seconds.**

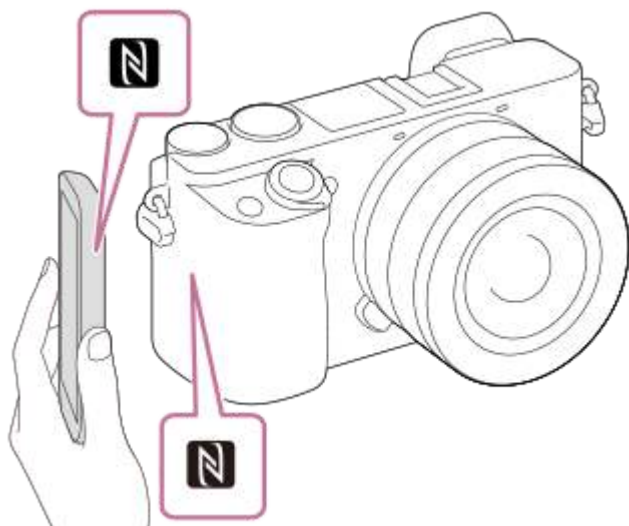

The product and the smartphone are connected, and then the displayed image is sent to the smartphone.

- Before you touch the smartphone, cancel the sleep and lock-screen functions of the smartphone.
- The NFC function is available only when the **N** (N-Mark) is displayed on the product.
- To transfer two or more images, select MENU →  (Network) → [Send to Smartphone Func.] → [Send to Smartphone] to select images. After the connection enabled screen appears, use NFC to connect the product and the smartphone.

About “NFC”

NFC is a technology that enables short-range wireless communication between various devices, such as mobile phones or IC tags, etc. NFC makes data communication simpler with just a touch on the designated touch-point.

- NFC (Near Field Communication) is an international standard of short-range wireless communication technology.

Note

- You can select an image size to be sent to the smartphone from [Original], [2M] or [VGA]. To change the image size, refer to the following steps.

- For an Android smartphone
Start Imaging Edge Mobile, and change the image size by [Settings] → [Copy Image Size].
- For iPhone or iPad
Select Imaging Edge Mobile from Settings, and change the image size using [Copy Image Size].
- RAW images are converted to JPEG format when they are sent.
- You cannot send AVCHD format movies.
- Depending on the smartphone, the transferred movie may not be played back correctly. For example, the movie may not play smoothly, or there may be no sound.
- If the Image Index is displayed on the product, you cannot transfer images using the NFC function.
- If you cannot make a connection, do as the following:
 - Launch Imaging Edge Mobile on your smartphone, and then move the smartphone slowly toward the  (N-Mark) of this product.
 - If the smartphone is in a case, remove it.
 - If the product is in a case, remove it.
 - Check whether the NFC function is activated on your smartphone.
- When [Airplane Mode] is set to [On], you cannot connect the product and the smartphone. Set [Airplane Mode] to [Off].

Related Topic

- [Imaging Edge Mobile](#)
- [Send to Smartphone Func.: Send to Smartphone](#)
- [Send to Smartphone Func.: Sending Target \(proxy movies\)](#)
- [Airplane Mode](#)

Location Info. Link Set.

You can use the application Imaging Edge Mobile to obtain location information from a smartphone that is connected with your camera using Bluetooth communication. You can record the obtained location information when shooting images.

Preparation in advance









To use the location information linking function of the camera, the application Imaging Edge Mobile is required. If “Location Information Linkage” is not displayed on the top page of Imaging Edge Mobile, you need to perform the following steps beforehand.





1. Install Imaging Edge Mobile on your smartphone.
 - You can install Imaging Edge Mobile from the application store of your smartphone. If you have already installed the application, update it to the latest version.
2. Transfer a pre-recorded image to your smartphone using the [Send to Smartphone] function of the camera.
 - After you transfer an image recorded using the camera to your smartphone, “Location Information Linkage” will appear on the top page of the application.

Operating procedure

: Operations performed on the smartphone

: Operations performed on the camera

1. : Confirm that the Bluetooth function of your smartphone is activated.
 - Do not perform the Bluetooth pairing operation on the smartphone setting screen. In steps 2 to 7, the pairing operation is performed using the camera and the application Imaging Edge Mobile.
 - If you accidentally perform the pairing operation on the smartphone setting screen in step 1, cancel the pairing and then perform the pairing operation by following Steps 2 through 7 using the camera and the application Imaging Edge Mobile.
2. : On the camera, select MENU →  (Network) → [Bluetooth Settings] → [Bluetooth Function] → [On].
3. : On the camera, select MENU →  (Network) → [Bluetooth Settings] → [Pairing].
4. : Launch Imaging Edge Mobile on your smartphone and tap “Location Information Linkage.”
 - If “Location Information Linkage” is not displayed, follow the steps in “Preparation in advance” above.
5. : Activate [Location Information Linkage] on the [Location Information Linkage] setting screen of Imaging Edge Mobile.
6. : Follow the instructions on the [Location Information Linkage] setting screen of Imaging Edge Mobile, and then select your camera from the list.
7. : Select [OK] when a message is displayed on the monitor of the camera.

- Pairing of the camera and Imaging Edge Mobile is complete.
8.  : On the camera, select MENU →  (Network) → [ Location Info. Link Set.] → [Location Info. Link] → [On].
-  (obtaining location information icon) will be displayed on the monitor of the camera. Location information obtained by your smartphone using GPS, etc., will be recorded when shooting images.

Menu item details

Location Info. Link:

Sets whether to obtain the location information by linking with a smartphone.

Auto Time Correct.:

Sets whether to automatically correct the date setting of the camera using information from a linked smartphone.

Auto Area Adjust.:

Sets whether to automatically correct the area setting of the camera using information from a linked smartphone.

Icons displayed when obtaining the location information

 (Obtaining location information): The camera is obtaining the location information.

 (Location information cannot be obtained): The camera cannot obtain the location information.

 (Bluetooth connection available): Bluetooth connection with the smartphone is established.

 (Bluetooth connection unavailable): Bluetooth connection with the smartphone is not established.

Hint

- Location information can be linked when Imaging Edge Mobile is running on your smartphone even if the smartphone monitor is off. However, if the camera has been turned off for a while, location information may not be linked immediately when you turn the camera back on. In this case, location information will be linked immediately if you open the Imaging Edge Mobile screen on the smartphone.
- When Imaging Edge Mobile is not operating, such as when the smartphone is restarted, launch Imaging Edge Mobile to resume location information linking.
- If the location information linking function does not work properly, see the following notes and perform pairing again.
 - Confirm that the Bluetooth function of your smartphone is activated.
 - Confirm that the camera is not connected with other devices using the Bluetooth function.
 - Confirm that [Airplane Mode] for the camera is set to [Off].
 - Delete the pairing information for the camera registered in Imaging Edge Mobile.
 - Execute [Reset Network Set.] of the camera.
- For more detailed instructions, refer to the following support page.
<https://www.sony.net/iem/btg/>

Note

- When you initialize the camera, the pairing information is also deleted. To perform pairing again, delete the pairing information for the camera registered in Imaging Edge Mobile before trying again.
- The location information will not be recorded when it cannot be obtained, such as when the Bluetooth connection is disconnected.
- The camera can be paired with up to 15 Bluetooth devices, but can link the location information with that of only one smartphone. If you want to link the location information with that of another smartphone, turn off the [Location Information Linkage] function of the smartphone that is already linked.
- If the Bluetooth connection is unstable, remove any obstacles, such as people or metal objects from between the camera and the paired smartphone.
- When pairing the camera and your smartphone, be sure to use the [Location Information Linkage] menu on Imaging Edge Mobile.
- To use the location information linkage function, set [Bluetooth Rmt Ctrl] to [Off].
- The communication distance for Bluetooth or Wi-Fi may vary depending on the conditions of use.

Supported smartphones

Refer to the support page for the latest information.

<https://www.sony.net/iem/>

- For details on Bluetooth versions compatible with your smartphone, check the product website for your smartphone.
-

Related Topic



- [Imaging Edge Mobile](#)
- [Send to Smartphone Func.: Send to Smartphone](#)
- [Bluetooth Settings](#)
- [Bluetooth Rmt Ctrl](#)

5-009-879-12(1) Copyright 2019 Sony Corporation

Interchangeable Lens Digital Camera
ILCE-6100 α6100

Bluetooth Rmt Ctrl

You can operate the camera using a Bluetooth remote commander RMT-P1BT (sold separately). Select MENU →  (Network) → [Bluetooth Settings] → [Bluetooth Function] → [On] in advance. Refer to the instruction manual for the Bluetooth remote commander as well.

- 1 On the camera, select MENU →  (Network) → [Bluetooth Rmt Ctrl] → [On].**
 - If there is no Bluetooth device currently paired with the camera, the screen for pairing as described in Step 2 will appear.
- 2 On the camera, select MENU →  (Network) → [Bluetooth Settings] → [Pairing] to display the screen for pairing.**
- 3 On the Bluetooth remote commander, perform pairing.**
 - For details, refer to the instruction manual for the Bluetooth remote commander.
- 4 On the camera, select [OK] on the confirmation screen for the Bluetooth connection.**
 - Pairing is complete, and you can now operate the camera from the Bluetooth remote commander. After pairing the device once, you can connect the camera and the Bluetooth remote commander again in the future by setting [Bluetooth Rmt Ctrl] to [On].

Menu item details

On:

Enables Bluetooth remote commander operation.

Off:

Disables Bluetooth remote commander operation.

Hint

- The Bluetooth connection is only active while you are operating the camera using the Bluetooth remote commander.
- If the function does not work properly, check the following notes and then try pairing again.
 - Confirm that the camera is not connected with other devices using the Bluetooth function.
 - Confirm that [Airplane Mode] for the camera is set to [Off].
 - Execute [Reset Network Set.] of the camera.

Note

- When you initialize the camera, the pairing information is also deleted. To use the Bluetooth remote commander, perform pairing again.
- If the Bluetooth connection is unstable, remove any obstacles, such as people or metal objects from between the camera and the paired Bluetooth remote commander.
- You cannot use the function for linking location information with a smartphone while [Bluetooth Rmt Ctrl] is set to [On].
- While [Bluetooth Rmt Ctrl] is set to [On], the camera will not switch to the power-saving mode. Change the setting to [Off] when you are done using the Bluetooth remote commander.

Related Topic

- [Bluetooth Settings](#)

5-009-879-12(1) Copyright 2019 Sony Corporation

Interchangeable Lens Digital Camera
ILCE-6100 α6100

View on TV

You can view images on a network-enabled TV by transferring them from the product without connecting the product and TV with a cable. For some TVs, you may need to perform operations on the TV. For details, refer to the operating instructions supplied with the TV.

1 MENU →  (Network) → [View on TV] → desired device to be connected.

2 When you want to play back images using slideshow, press the center of the control wheel.

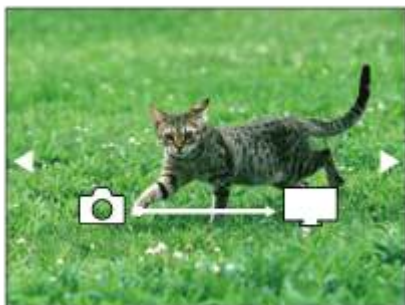

- To display the next/previous image manually, press the right/left sides of the control wheel.
- To change the device to be connected, press the down side of the control wheel, then select [Device list].

Slideshow settings

You can change the slideshow settings by pressing the down side of the control wheel.

Playback Selection:

Selects the group of images to be shown.

Folder View(Still):

Selects from [All] and [All in Folder].

Date View:

Selects from [All] and [All in Date Rng.].

Interval:

Selects from [Short] and [Long].

Effects*:

Selects from [On] and [Off].

Playback Image Size:

Selects from [HD] and [4K].

* The settings are effective only for BRAVIA TV which is compatible with the functions.

Note

- You can use this function on a TV that supports DLNA renderer.
- You can view images on a Wi-Fi Direct-enabled TV or network-enabled TV (including wired network-enabled TVs).
- If you connect TV and this product and do not use Wi-Fi Direct, you need to register your access point first.
- Displaying the images on the TV may take time.
- Movies cannot be shown on a TV via Wi-Fi. Use an HDMI cable (sold separately).
- When [Display as Group] is set to [On], only the first image of the group is transferred to the TV.

Related Topic

- [Wi-Fi Settings: WPS Push](#)
- [Wi-Fi Settings: Access Point Set.](#)

5-009-879-12(1) Copyright 2019 Sony Corporation

Interchangeable Lens Digital Camera
ILCE-6100 α6100

Airplane Mode

When you board an airplane, etc., you can temporarily disable all the wireless-related functions including Wi-Fi.

1 MENU →  (Network) → [Airplane Mode] → **desired setting.**

If you set [Airplane Mode] to [On], an airplane mark will be displayed on the screen.

Interchangeable Lens Digital Camera
ILCE-6100 α6100

Wi-Fi Settings: WPS Push

If your access point has a Wi-Fi Protected Setup (WPS) button, you can register the access point to this product easily.

- 1 MENU →  (Network) → [Wi-Fi Settings] → [WPS Push].
- 2 Push the Wi-Fi Protected Setup (WPS) button on the access point to connect.

Note

- [WPS Push] works only if the security setting of your access point is set to WPA or WPA2 and your access point supports the Wi-Fi Protected Setup (WPS) button method. If the security setting is set to WEP or your access point does not support the Wi-Fi Protected Setup (WPS) button method, perform [Access Point Set.].
- For details about the available functions and settings of your access point, see the access point operating instructions or contact the administrator of the access point.
- A connection may not be possible or the communication distance may be shorter depending on the surrounding conditions, such as the type of wall material and the presence of obstructions or radio waves between the product and access point. In this case, change the location of the product or move the product closer to the access point.

Related Topic

- [Wi-Fi Settings: Access Point Set.](#)

Wi-Fi Settings: Access Point Set.

You can register your access point manually. Before starting the procedure, check the SSID name of the access point, security system, and password. The password may be preset in some devices. For details, see the access point operating instructions, or consult the access point administrator.

1 MENU →  (Network) → [Wi-Fi Settings] → [Access Point Set.].

2 Select the access point you want to register.

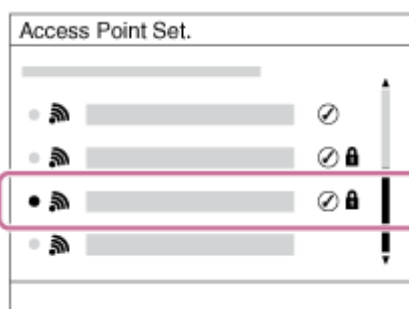

When the desired access point is displayed on the screen: Select the desired access point.

When the desired access point is not displayed on the screen: Select [Manual Setting] and set the access point.

- If you select [Manual Setting], input the SSID name of the access point, then select the security system.

3 Input the password, and select [OK].

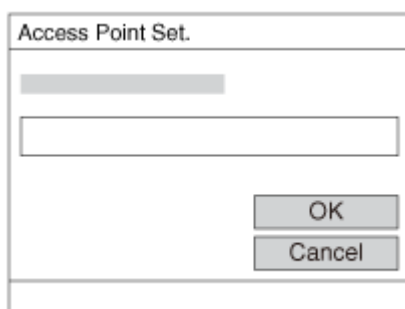

- Access points without the  mark do not require a password.

4 Select [OK].

Other setting items

Depending on the status or the setting method of your access point, you may want to set more items.

WPS PIN:

Displays the PIN code you enter into the connected device.

Priority Connection:

Select [On] or [Off].

IP Address Setting:

Select [Auto] or [Manual].

IP Address:

If you are entering the IP address manually, enter the set address.

Subnet Mask/Default Gateway:

If you have set [IP Address Setting] to [Manual], enter each address according to your network environment.

Note

- To give the registered access point priority in the future, set [Priority Connection] to [On].

Related Topic

- [Wi-Fi Settings: WPS Push](#)
- [How to use the keyboard](#)

Interchangeable Lens Digital Camera
ILCE-6100 α6100

Wi-Fi Settings: Disp MAC Address

Displays the Wi-Fi MAC address of this product.

1 MENU →  (Network) → [Wi-Fi Settings] → [Disp MAC Address].

Interchangeable Lens Digital Camera
ILCE-6100 α6100

Wi-Fi Settings: SSID/PW Reset

This product shares connection information for [Send to Smartphone] and [□ Connection] under [Ctrl w/ Smartphone] with devices that have permission to connect. If you want to change the devices that are permitted to connect, reset the connection information.

1 MENU →  (Network) → [Wi-Fi Settings] → [SSID/PW Reset] → [OK].

Note

- If you connect this product to a smartphone after resetting the connection information, you must make the settings for the smartphone again.

Related Topic

- [Send to Smartphone Func.: Send to Smartphone](#)
- [Ctrl w/ Smartphone](#)

Interchangeable Lens Digital Camera
ILCE-6100 α6100

Bluetooth Settings

Controls the settings for connecting the camera to a smartphone or Bluetooth remote commander via a Bluetooth connection.

If you want to pair the camera and smartphone in order to use the location information link function, refer to “Location Info. Link Set..”

If you want to perform pairing in order to use a Bluetooth remote commander, refer to “Bluetooth Rmt Ctrl.”

1 MENU →  (Network) → [Bluetooth Settings] → desired setting.

Menu item details

Bluetooth Function (On/Off):

Sets whether to activate or not the Bluetooth function of the camera.

Pairing:

Displays the screen for pairing the camera and smartphone or Bluetooth remote commander.

Disp Device Address:

Displays the BD address of the camera.

Related Topic

- [Location Info. Link Set.](#)
- [Bluetooth Rmt Ctrl](#)

Interchangeable Lens Digital Camera
ILCE-6100 α6100

Edit Device Name

You can change the device name for the Wi-Fi Direct or Bluetooth connection.

- 1 **MENU** →  **(Network)** → **[Edit Device Name]**.
- 2 **Select the input box, then input the device name** → **[OK]**.

Related Topic

- [Wi-Fi Settings: WPS Push](#)
- [Wi-Fi Settings: Access Point Set.](#)
- [How to use the keyboard](#)

Interchangeable Lens Digital Camera
ILCE-6100 α6100

Reset Network Set.

Resets all the network settings to default settings.

1 MENU →  (Network) → [Reset Network Set.] → [Enter].

Interchangeable Lens Digital Camera
ILCE-6100 α6100

Recommended computer environment

You can confirm the operating computer environment of the software from the following URL:

<https://www.sony.net/pcenv/>

Interchangeable Lens Digital Camera
ILCE-6100 α6100

PlayMemories Home

With PlayMemories Home, you can do the following:

- You can import images shot with this product to your computer.
- You can play back the images imported to your computer.
- You can share your images using PlayMemories Online.
- You can edit movies such as by cutting or merging.
- You can add various effects such as BGM and subtitles to movies.

Also for Windows, you can do the following:

- You can organize images on the computer on a calendar by shooting date to view them.
- You can edit and correct images, such as by trimming and resizing.
- You can create a disc from movies imported to a computer.
Blu-ray discs or AVCHD discs can be created from XAVC S-format movies.
- You can upload images to a network service. (An Internet connection is required.)
- For other details, please refer to the Help of PlayMemories Home.

Related Topic

- [Installing PlayMemories Home](#)

Installing PlayMemories Home

- 1 Using your computer's Internet browser, go to the URL below and download PlayMemories Home by following the on-screen instructions.

<https://www.sony.net/pm/>

- An Internet connection is required.
- For detailed instructions, visit the PlayMemories Home support page.
<https://www.sony.co.jp/pmh-se/>

- 2 Connect the product to your computer using the micro USB cable (supplied), then turn the product on.

- New functions may be added to PlayMemories Home. Even if PlayMemories Home has already been installed on your computer, connect this product and your computer again.
- Do not remove the micro USB cable (supplied) from the camera while the camera is in operation or the access screen is displayed. Doing so may damage the data.

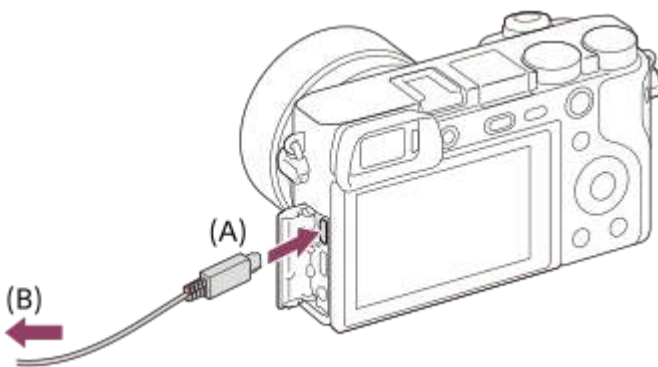

- A:** To the Multi/Micro USB Terminal
B: To the USB jack of the computer

Note

- Log on as Administrator.
- It may be necessary to restart your computer. When the restart confirmation message appears, restart the computer following the instructions on the screen.
- DirectX may be installed depending on your computer's system environment.

Connecting to a computer

- 1 Insert a sufficiently charged battery pack into the camera, or connect the camera to a wall outlet (wall socket) using an AC Adaptor (sold separately).
- 2 Turn on the camera and the computer.
- 3 Check that [USB Connection] under  (Setup) is set to [Mass Storage].
- 4 Connect the camera to the computer using the micro USB cable (supplied) (A).

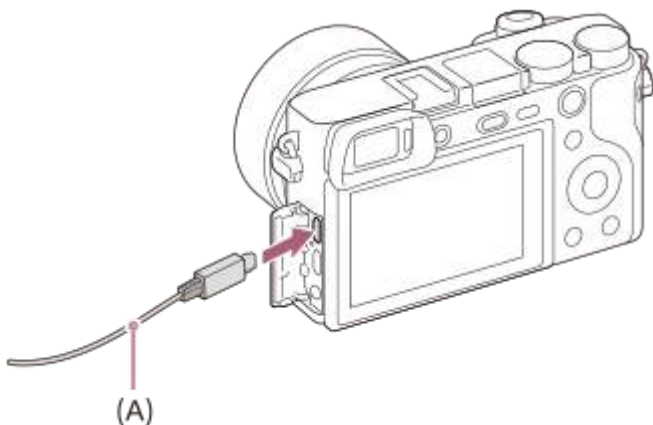

- When you connect the camera to the computer for the first time, the procedure for recognizing the camera may start automatically on the computer. Wait until the procedure is finished.
- If you connect the product to your computer using the micro USB cable when [USB Power Supply] is set to [On], power is supplied from your computer. (Default setting: [On])

Note

- Do not turn on/off or restart the computer, or wake the computer from sleep mode when a USB connection has been established between the computer and the camera. Doing so may cause a malfunction. Before turning on/off or restarting the computer, or waking the computer from sleep mode, disconnect the camera from the computer.

Related Topic

- [USB Connection](#)
- [USB LUN Setting](#)

Interchangeable Lens Digital Camera
ILCE-6100 α6100

Importing images to the computer without using PlayMemories Home

PlayMemories Home allows you to easily import images. For details on PlayMemories Home functions, see the Help of PlayMemories Home.

Importing images to the computer without using PlayMemories Home (For Windows)

When the AutoPlay Wizard appears after making a USB connection between this product and a computer, click [Open folder to view files] → [OK] → [DCIM]. Then copy the desired images to the computer.

Importing images to the computer without using PlayMemories Home (For Mac)

Connect the product to your Mac computer. Double-click the newly recognized icon on the desktop → the folder in which the image you want to import is stored. Then drag and drop the image file on to the hard disk icon.

Note

- For operations such as importing XAVC S movies or AVCHD movies to the computer, use PlayMemories Home.
- Do not edit or otherwise process AVCHD or XAVC S movie files/folders from the connected computer. Movie files may be damaged or become unplayable. Do not delete or copy AVCHD movies or XAVC S movies on the memory card from the computer. Sony is not held liable for consequences resulting from such operations via the computer.
- If you delete images or perform other operations from the connected computer, the image database file may become inconsistent. In this case, repair the image database file.

Interchangeable Lens Digital Camera
ILCE-6100 α6100

Disconnecting the camera from the computer

Perform steps 1 and 2 below before performing the following operations:

- Disconnecting the micro USB cable.
- Removing a memory card.
- Turning off the product.

1 Click  (Safely Remove Hardware and Eject Media) in the taskbar.

2 Click the displayed message.

Note

- On Mac computers, drag and drop the memory card icon or the drive icon into the “Trash” icon. The camera will be disconnected from the computer.
- On some computers, the disconnection icon may not appear. In this case, you can skip the steps above.
- Do not remove the micro USB cable from the camera while the access lamp is lit. The data may be damaged.

Interchangeable Lens Digital Camera
ILCE-6100 α6100

Send to Computer

You can transfer images stored in the product to a computer connected to a wireless access point or wireless broadband router and easily make backup copies using this operation. Before starting this operation, install PlayMemories Home on your computer and register the access point on the product.

- 1 **Start your computer.**
- 2 **MENU** →  **(Network)** → **[Send to Computer]**.

Note

- Depending on the application settings of your computer, the product will turn off after saving the images to your computer.
- You can transfer images from the product to only one computer at a time.
- If you want to transfer images to another computer, connect the product and the computer via a USB connection and follow the instructions in PlayMemories Home.
- Proxy movies cannot be transferred.

Related Topic

- [Installing PlayMemories Home](#)
- [Wi-Fi Settings: WPS Push](#)
- [Wi-Fi Settings: Access Point Set.](#)

Interchangeable Lens Digital Camera
ILCE-6100 α6100

Imaging Edge

Imaging Edge is a software suite that includes functions such as remote shooting from a computer, and adjusting or developing RAW images recorded with the camera.

Viewer:

You can display and search images.

Edit:

You can edit images with various corrections such as tone curve and sharpness, and develop images recorded in RAW format.

Remote:

You can adjust the camera settings or shoot images from a computer connected to the camera with a USB cable. To control the camera using the computer, select MENU →  (Setup) → [USB Connection] → [PC Remote], and then connect the camera to the computer with a USB cable.

For details on how to use Imaging Edge, refer to the support page.

<https://www.sony.net/disoft/help/>

Installing Imaging Edge on your computer

Download and install the software by accessing the following URL:

<https://www.sony.net/disoft/d/>

Related Topic

- [USB Connection](#)

Interchangeable Lens Digital Camera
ILCE-6100 α6100

Selecting a disc to be created

You can create a disc that can be played back on other devices from a movie recorded on this camera. What devices can play back the disc depends on the disc type. Select a disc type suitable for the playback devices you will be using.

Depending on the movie type, the movie format may be converted when creating a disc.



High-definition image quality (HD) (Blu-ray Disc)

High-definition image quality (HD) movies can be recorded on a Blu-ray Disc, creating a high-definition image quality (HD) disc.

A Blu-ray Disc enables you to record longer-duration high-definition image quality (HD) movies than DVD discs.

Writable movie formats: XAVC S, AVCHD

Players: Blu-ray Disc playback devices (Sony Blu-ray Disc players, PlayStation 4, etc.)



High-definition image quality (HD) (AVCHD recording disc)

High-definition image quality (HD) movies can be recorded on DVD media such as DVD-R discs, creating a high-definition image quality (HD) disc.

Writable movie formats: XAVC S, AVCHD

Players: AVCHD format playback devices (Sony Blu-ray Disc players, PlayStation 4, etc.)

You cannot play these kinds of discs on ordinary DVD players.



Standard definition image quality (STD)

Standard definition image quality (STD) movies converted from high-definition image quality (HD) movies can be recorded on DVD media such as DVD-R discs, creating a standard image quality (STD) disc.

Writable movie formats: AVCHD

Players: Ordinary DVD playback devices (DVD players, computers that can play back DVD discs, etc.)

Hint

- You can use the following types of 12 cm discs with PlayMemories Home.
BD-R/DVD-R/DVD+R/DVD+R DL: Non-rewritable
BD-RE/DVD-RW/DVD+RW: Rewritable
Additional recording is not possible.
- Always maintain your "PlayStation 4" to use the latest version of the "PlayStation 4" system software.

Note

- 4K movies cannot be recorded on a disc in 4K image quality.

- Creating Blu-ray Discs from high-definition image quality movies
- Creating DVD discs (AVCHD recording discs) from high-definition image quality movies
- Creating DVD discs from standard image quality movies

5-009-879-12(1) Copyright 2019 Sony Corporation

Interchangeable Lens Digital Camera
ILCE-6100 α6100

Creating Blu-ray Discs from high-definition image quality movies

You can create Blu-ray Discs that can be played back on Blu-ray Disc playback devices (such as Sony Blu-ray Disc players or the PlayStation 4, etc.).

A. How to create using a computer

With a Windows computer, you can copy movies imported to the computer and create Blu-ray Discs using PlayMemories Home.

Your computer must be able to create Blu-ray Discs.

When you create a Blu-ray Disc for the first time, connect your camera to the computer using a USB cable. The necessary software is automatically added to your computer. (An Internet connection is needed.)

For details on how to create a disc using PlayMemories Home, refer to the Help guide for PlayMemories Home.

B. How to create using a device other than a computer

You can also create Blu-ray Discs using a Blu-ray recorder, etc.

For details, refer to the device's operating instructions.

Note

- When creating Blu-ray discs using PlayMemories Home from movies recorded in the XAVC S movie format, the image quality is converted to 1920×1080 (60i/50i). It is not possible to create discs with the original image quality. To record movies with the original image quality, copy movies to a computer or an external medium.

Related Topic

- [Selecting a disc to be created](#)
- [Creating DVD discs \(AVCHD recording discs\) from high-definition image quality movies](#)
- [Creating DVD discs from standard image quality movies](#)

Interchangeable Lens Digital Camera
ILCE-6100 α6100

Creating DVD discs (AVCHD recording discs) from high-definition image quality movies

You can create DVD discs (AVCHD recording discs) that can be played back on AVCHD-compatible playback devices (such as Sony Blu-ray Disc players or the PlayStation 4, etc.).

A. How to create using a computer

With a Windows computer, you can copy movies imported to the computer and create DVD discs (AVCHD recording discs) using PlayMemories Home.

Your computer must be able to create DVD discs (AVCHD recording discs).

When you create a DVD disc for the first time, connect your camera to the computer using a USB cable. The necessary software is automatically added to your computer. (An Internet connection is needed.)

For details on how to create a disc using PlayMemories Home, refer to the Help guide for PlayMemories Home.

B. How to create using a device other than a computer

You can also create DVD discs (AVCHD recording discs) using a Blu-ray recorder, etc.

For details, refer to the device's operating instructions.

Note

- When creating DVD discs (AVCHD recording discs) using PlayMemories Home from movies recorded in the XAVC S movie format, the image quality is converted to 1920×1080 (60i/50i). It is not possible to create discs with the original image quality. To record movies with the original image quality, copy movies to a computer or an external medium.
- When creating AVCHD recording discs using PlayMemories Home from movies recorded in the AVCHD movie format with [ Record Setting] set to [60i 24M(FX) Super 35mm]/[50i 24M(FX) Super 35mm], the image quality is converted and it is not possible to create discs with the original image quality. This conversion can take a long time. To record movies with the original image quality, use a Blu-ray Disc.

Related Topic

- [Selecting a disc to be created](#)
- [Creating Blu-ray Discs from high-definition image quality movies](#)
- [Creating DVD discs from standard image quality movies](#)

Interchangeable Lens Digital Camera
ILCE-6100 α6100

Creating DVD discs from standard image quality movies

You can create DVD discs that can be played back on ordinary DVD playback devices (DVD players, computers that can play back DVD discs, etc.).

A. How to create using a computer

With a Windows computer, you can copy movies imported to the computer and create DVD disc using PlayMemories Home.

Your computer must be able to create DVD discs.

When you create a DVD disc for the first time, connect your camera to the computer using a USB cable. Install the dedicated add-on software following the on-screen instructions. (An internet connection is needed.)

For details on how to create a disc using PlayMemories Home, refer to the Help for PlayMemories Home.

B. How to create using a device other than a computer

You can also create DVD discs using a Blu-ray recorder, HDD recorder, etc.

For details, refer to the device's operating instructions.

Related Topic

- [Selecting a disc to be created](#)
- [Creating Blu-ray Discs from high-definition image quality movies](#)
- [Creating DVD discs \(AVCHD recording discs\) from high-definition image quality movies](#)

Interchangeable Lens Digital Camera
ILCE-6100 α6100

Using MENU items

You can change settings related to all the camera operations including shooting, playback, and operating method. You can also execute camera functions from the MENU.

- 1 Press the MENU button to display the menu screen.

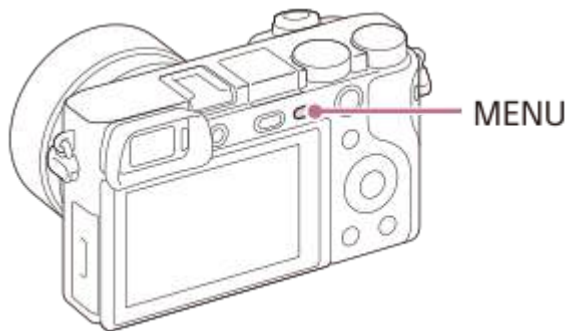

- 2 Select the desired setting you want to adjust using the top/bottom/left/right sides of the control wheel or by turning the control wheel, and then press the center of the control wheel.

- Select a MENU tab (A) at the top of the screen, and press the left/right side of the control wheel to move to another MENU tab.
- You can go back to the previous screen by pressing the MENU button.



- 3 Select the desired setting value, and press the center to confirm your selection.



Related Topic

- [Tile Menu](#)
- [Add Item](#)

Interchangeable Lens Digital Camera
ILCE-6100 α6100

File Format (still image)

Sets the file format for still images.

1 MENU →  1 (Camera Settings1) → [ File Format] → desired setting.

Menu item details

RAW:

Digital processing is not performed on this file format. Select this format to process images on a computer for professional purposes.



RAW & JPEG:

A RAW image and a JPEG image are created at the same time. This is suitable when you need two image files, a JPEG for viewing, and a RAW for editing.

JPEG:

The image is recorded in the JPEG format.

About RAW images

- To open a RAW image file recorded with this camera, the software Imaging Edge is needed. With Imaging Edge, you can open a RAW image file, then convert it into a popular image format such as JPEG or TIFF, or readjust the white balance, saturation or contrast of the image.
- You cannot apply [Auto HDR] or [Picture Effect] functions with RAW images.
- RAW images shot by the camera are recorded in the compressed RAW format.
- RAW images recorded with this camera have a resolution of 14 bits per pixel. However, resolution is limited to 12 bits in the following shooting modes:
 - [ Long Exposure NR]
 - [BULB]
 - [Cont. Shooting] (including continuous shooting in [Superior Auto] mode)
 - [ Silent Shooting]

Note

- If you do not intend to edit the images on your computer, we recommend that you record in JPEG format.
- You cannot add DPOF (print order) registration marks to RAW images.



Related Topic

- [JPEG Image Size \(still image\)](#)

Interchangeable Lens Digital Camera
ILCE-6100 α6100

JPEG Quality (still image)

Selects the JPEG image quality when [ File Format] is set to [RAW & JPEG] or [JPEG].

① MENU →  1 (Camera Settings1) → [ JPEG Quality] → desired setting.

Menu item details

Extra fine/Fine/Standard:

Since the compression rate increases from [Extra fine] to [Fine] to [Standard], the file size decreases in the same order. This allows more files to be recorded on one memory card, but the image quality is lower.



Related Topic

- [File Format \(still image\)](#)

Interchangeable Lens Digital Camera
ILCE-6100 α6100

JPEG Image Size (still image)

The larger the image size, the more detail will be reproduced when the image is printed on large-format paper. The smaller the image size, the more images can be recorded.

① MENU →  1 (Camera Settings1) → [ JPEG Image Size] → desired setting.

Menu item details

When [ Aspect Ratio] is set to 3:2	
L: 24M	6000×4000 pixels
M: 12M	4240×2832 pixels
S: 6.0M	3008×2000 pixels

When [ Aspect Ratio] is set to 16:9	
L: 20M	6000×3376 pixels
M: 10M	4240×2400 pixels
S: 5.1M	3008×1688 pixels

When [ Aspect Ratio] is set to 1:1	
L: 16M	4000×4000 pixels
M: 8.0M	2832×2832 pixels
S: 4.0M	2000×2000 pixels

Note



- When [ File Format] is set to [RAW] or [RAW & JPEG], the image size for RAW images corresponds to “L.”

Related Topic

- [Aspect Ratio \(still image\)](#)

Interchangeable Lens Digital Camera
ILCE-6100 α6100

Aspect Ratio (still image)

① MENU →  1 (Camera Settings1) → [ Aspect Ratio] → desired setting.

Menu item details

3:2:

Same aspect ratio as 35 mm film

16:9:

The aspect ratio is 16:9.

1:1:

The horizontal and vertical ratio is equal.

Interchangeable Lens Digital Camera
ILCE-6100 α6100

Panorama: Size

Sets the image size when shooting panoramic images. The image size varies depending on the [Panorama: Direction] setting.

① MENU →  1 (Camera Settings1) → [Panorama: Size] → desired setting.

Menu item details

When [Panorama: Direction] is set to [Up] or [Down]

Standard: 3872×2160

Wide: 5536×2160

When [Panorama: Direction] is set to [Left] or [Right]

Standard: 8192×1856

Wide: 12416×1856

Related Topic

- [Sweep Panorama](#)
- [Panorama: Direction](#)

Interchangeable Lens Digital Camera
ILCE-6100 α6100

Panorama: Direction

Sets the direction to pan the camera when shooting panoramic images.

1 MENU →  1 (Camera Settings1) → [Panorama: Direction] → desired setting.

Menu item details

Right:

Pan the camera from the left to the right.

Left:

Pan the camera from the right to the left.

Up:

Pan the camera from the bottom to the top.

Down:

Pan the camera from the top to the bottom.



Related Topic

- [Sweep Panorama](#)

Interchangeable Lens Digital Camera
ILCE-6100 α6100

Long Exposure NR (still image)

When you set the shutter speed to 1 second(s) or longer (long exposure shooting), noise reduction is turned on for the duration that the shutter is open. With the function turned on, the grainy noise typical of long exposures is reduced.



1 MENU →  1 (Camera Settings1) → [ Long Exposure NR] → desired setting.

Menu item details

On:
Activates noise reduction for the same duration that the shutter is open. When noise reduction is in progress, a message appears and you cannot take another picture. Select this to prioritize the image quality.

Off:
Does not activate noise reduction. Select this to prioritize the timing of shooting.



Note

- Noise reduction may not be activated even if [ Long Exposure NR] is set to [On] in the following situations:
 - The shooting mode is set to [Sweep Panorama].
 - [Drive Mode] is set to [Cont. Shooting] or [Cont. Bracket].
 - The shooting mode is set to [Scene Selection] and [Sports Action], [Hand-held Twilight] or [Anti Motion Blur] is selected.
 - The ISO sensitivity is set to [Multi Frame NR].
- [ Long Exposure NR] cannot be set to [Off] in the following shooting modes:
 - [Intelligent Auto]
 - [Superior Auto]
 - [Scene Selection]

Interchangeable Lens Digital Camera
ILCE-6100 α6100

High ISO NR (still image)

When shooting with high ISO sensitivity, the product reduces noise that becomes more noticeable when the product sensitivity is high.

1 MENU →  1 (Camera Settings1) →  High ISO NR → desired setting.

Menu item details

Normal:

Activates high ISO noise reduction normally.





Low:

Activates high ISO noise reduction moderately.

Off:

Does not activate high ISO noise reduction. Select this to prioritize the timing of shooting.



Note

-  High ISO NR is fixed to [Normal] in the following shooting modes:
 - [Intelligent Auto]
 - [Superior Auto]
 - [Scene Selection]
 - [Sweep Panorama]
- When  File Format is set to [RAW], this function is not available.
-  High ISO NR does not work for RAW images when the  File Format is [RAW & JPEG].

Interchangeable Lens Digital Camera
ILCE-6100 α6100

Color Space (still image)

The way colors are represented using combinations of numbers or the range of color reproduction is called “color space.” You can change the color space depending on the purpose of the image.

① MENU →  1 (Camera Settings1) → [ Color Space] → desired setting.

Menu item details

sRGB:

This is the standard color space of the digital camera. Use [sRGB] in normal shooting, such as when you intend to print out the images without any modification.

AdobeRGB:

This color space has a wide range of color reproduction. When a large part of the subject is vivid green or red, Adobe RGB is effective. The file name of the recorded image starts with “_.”

Note

- [AdobeRGB] is for applications or printers that support color management and DCF2.0 option color space. Images may not be printed or viewed in the correct colors if you use applications or printers that do not support Adobe RGB.
- When displaying images that were recorded with [AdobeRGB] on non-Adobe RGB-compliant devices, the images will be displayed with low saturation.

Interchangeable Lens Digital Camera
ILCE-6100 α6100

Lens Comp.

Compensates for shading in the corners of the screen or distortion of the screen, or reduces color deviation at the corners of the screen caused by certain lens characteristics.

1 MENU →  1 (Camera Settings1) → [Lens Comp.] → desired setting.

Menu item details

Shading Comp.:

Sets whether to automatically compensate for darkness in the corners of the screen. ([Auto]/[Off])

Chromatic Aberration Comp.:

Sets whether to automatically reduce color deviation at the corners of the screen. ([Auto]/[Off])

Distortion Comp.:

Sets whether to automatically compensate for distortion of the screen. ([Auto]/[Off])

Note

- This function is only available when using an automatic compensation compliant lens.
- Darkness in the corners of the screen may not be corrected with [Shading Comp.], depending on the lens type.
- Depending on the attached lens, [Distortion Comp.] is fixed to [Auto], and you cannot select [Off].

Interchangeable Lens Digital Camera
ILCE-6100 α6100

Switching the auto mode (Auto Mode)

This camera is equipped with the following two automatic shooting modes: [Intelligent Auto] and [Superior Auto]. You can switch the auto mode to shoot according to the subject and your preferences.

- 1 Set the mode dial to **AUTO**.
- 2 MENU →  1 (Camera Settings1) → [Auto Mode] → desired setting.

Menu item details

Intelligent Auto:

Allows you to shoot with automatic scene recognition.

Superior Auto:

Allows you to shoot with automatic scene recognition. This mode takes clear images of dark or backlit scenes.

Note

- In [Superior Auto] mode, the recording process takes longer, since the product creates a composite image. In this case, the shutter sound is heard multiple times, but only one image is recorded.
- For [Intelligent Auto] and [Superior Auto] mode, most of the functions are set automatically, and you cannot adjust the settings on your own.

Related Topic

- [Intelligent Auto](#)
- [Superior Auto](#)

Interchangeable Lens Digital Camera
ILCE-6100 α6100

Scene Selection

Allows you to shoot with preset settings according to the scene.

- 1 Set the mode dial to SCN (Scene Selection).
- 2 Turn the control dial to select the desired setting.

Menu item details

Portrait:

Blurs background and sharpens the subject. Accentuates the skin tones softly.



Sports Action:

Shoots a moving subject at a fast shutter speed so that the subject looks as if it is standing still. The product shoots images continuously while the shutter button is pressed.



Macro:

Shoots close-ups of the subjects, such as flowers, insects, food, or small items.



Landscape:

Shoots the entire range of a scenery in sharp focus with vivid colors.



Sunset:

Shoots the red of the sunset beautifully.



🌙 Night Scene:

Shoots night scenes without losing the dark atmosphere.



🖐️ Hand-held Twilight:

Shoots night scenes with less noise and blur without using a tripod. A burst of shots are taken, and image processing is applied to reduce subject blur, camera-shake, and noise.



👤🌙 Night Portrait:

Shoots night scene portraits using the flash.

The flash does not pop up automatically. Pop up the flash manually before shooting.



👤👤 Anti Motion Blur:

Allows you to shoot indoor shots without using the flash and reduces subject blur. The product shoots burst images and combines them to create the image, reducing subject blur and noise.



Hint

- To change the scene, rotate the control dial on the shooting screen and select a new scene.

Note

- Under the following settings, the shutter speed is slower, so use of a tripod, etc. is recommended to prevent the image from blurring:
 - [Night Scene]
 - [Night Portrait]
- In the [Hand-held Twilight] or [Anti Motion Blur] mode, the shutter clicks 4 times and an image is recorded.
- If you select [Hand-held Twilight] or [Anti Motion Blur] with [RAW] or [RAW & JPEG], [📷 File Format] becomes [JPEG] temporarily.

- Reducing blur is less effective even in [Hand-held Twilight] or [Anti Motion Blur] when shooting the following subjects:
 - Subjects with erratic movement.
 - Subjects that are too close to the product.
 - Subjects with continuously similar patterns, such as the sky, a beach, or a lawn.
 - Subjects with constant change such as waves or water falls.
- In the case of [Hand-held Twilight] or [Anti Motion Blur], block noise may occur when using a light source that flickers, such as fluorescent lighting.
- The minimum distance that you can come close to a subject does not change even if you select [Macro]. For the minimum in-focus range, refer to the minimum distance of the lens attached to the product.

Related Topic

- [Using flash](#)

5-009-879-12(1) Copyright 2019 Sony Corporation

Interchangeable Lens Digital Camera
ILCE-6100 α6100

Superior Auto Img. Extract.

Sets whether or not to save all the images that were shot continuously in [Superior Auto].

1 MENU →  1 (Camera Settings1) → [Superior Auto Img. Extract.] → desired setting.

Menu item details

Auto:

Saves one appropriate image selected by the product.

Off:

Saves all of the images.



Note

- Even if you set [Superior Auto Img. Extract.] to [Off] with [Hand-held Twilight] selected as the scene recognition mode, one combined image is saved.
- When the Auto Framing function is activated, two images are saved even if you set [Superior Auto Img. Extract.] to [Auto].
- When [ Quality] is set to [RAW] or [RAW & JPEG], the shooting function will be limited.

Interchangeable Lens Digital Camera
ILCE-6100 α6100

Drive Mode

Select the appropriate mode for the subject, such as single shooting, continuous shooting or bracketing shooting.

- 1 Select  /  (Drive Mode) on the control wheel → desired setting.
 - You can also set the drive mode by selecting MENU →  1 (Camera Settings1) → [Drive Mode].
- 2 Select the desired mode using the right/left side of the control wheel.

Menu item details

Single Shooting :

Normal shooting mode.

Cont. Shooting :

Shoots images continuously while you press and hold down the shutter button.

Self-timer :

Shoots an image using the self-timer after a designated number of seconds have elapsed since the shutter button was pressed.

Self-timer(Cont) :

Shoots a designated number of images using the self-timer after a designated number of seconds have elapsed since the shutter button was pressed.

Cont. Bracket :

Shoots images while holding the shutter button down, each with different degrees of exposure.

Single Bracket :

Shoots a specified number of images, one by one, each with a different degrees of exposure.

WB bracket :

Shoots a total of three images, each with different color tones according to the selected settings for white balance, color temperature and color filter.

DRO Bracket :

Shoots a total of three images, each at a different degree of D-Range Optimizer.

Note





- When the shooting mode is set to [Scene Selection] and [Sports Action] is selected, [Single Shooting] cannot be performed.

Related Topic

- [Cont. Shooting](#)
- [Self-timer](#)
- [Self-timer\(Cont\)](#)
- [Cont. Bracket](#)
- [Single Bracket](#)
- [WB bracket](#)
- [DRO Bracket](#)

Bracket Settings

You can set the self-timer in bracket shooting mode, and the shooting order for exposure bracketing and white balance bracketing.

- 1 Select  /  (Drive Mode) of the control wheel → select bracket shooting mode.
 - You can also set the drive mode by selecting MENU →  1 (Camera Settings1) → [Drive Mode].
- 2 MENU →  1 (Camera Settings1) → [Bracket Settings] → desired setting.

Menu item details

Selftimer during Bracket:

Sets whether to use the self-timer during bracket shooting. Also sets the number of seconds until the shutter is released if using the self-timer.

(OFF/2 Sec/5 Sec/10 Sec)

Bracket order:

Sets the order of exposure bracketing and white balance bracketing.

(0→→+/-→0→+)

Related Topic

- [Cont. Bracket](#)
- [Single Bracket](#)
- [WB bracket](#)
- [DRO Bracket](#)

Interchangeable Lens Digital Camera
ILCE-6100 α6100

Interval Shoot Func.

You can automatically shoot a series of still images with the shooting interval and number of shots that you set in advance (Interval shooting). You can then create a movie from the still images produced by interval shooting using the computer software Imaging Edge (Viewer). You cannot create a movie from the still images on the camera.

For details on interval shooting, refer to the following URL:

<https://support.d-imaging.sony.co.jp/support/tutorial/ilc//ilce-6100/interval.php>

1 MENU →  1 (Camera Settings1) → [ Interval Shoot Func.] → [Interval Shooting] → [On].

2 MENU →  1 (Camera Settings1) → [ Interval Shoot Func.] → Select the item you want to set and the desired setting.

3 Press the shutter button.

When the time set for [Shooting Start Time] has elapsed, shooting will start.

- When the number of shots set for [Number of Shots] is completed, the camera will return to the standby screen for interval shooting.

Menu item details

Interval Shooting:

Sets whether to perform interval shooting. ([On]/[Off])

Shooting Start Time:

Sets the time from when you press the shutter button to when interval shooting starts. (1 second to 99 minutes 59 seconds)

Shooting Interval:

Sets the shooting interval (time from when one exposure starts to when the exposure for the next shot starts). (1 second to 60 seconds)

Number of Shots:

Sets the number of shots for interval shooting. (1 shot to 9999 shots)

AE Tracking Sensitivity:

Sets the tracking sensitivity of the auto exposure against the change in luminance during interval shooting. If you select [Low], exposure changes during interval shooting will be smoother. ([High]/[Mid]/[Low])



Silent Shoot. in Interval:

Sets whether or not to perform silent shooting during interval shooting. ([On]/[Off])

Shoot Interval Priority:

Sets whether or not to prioritize the shooting interval when the exposure mode is [Program Auto] or [Aperture Priority] and the shutter speed becomes longer than the time set for [Shooting Interval]. ([On]/[Off])

Hint

- If you press the shutter button during interval shooting, interval shooting will end and the camera will return to the standby screen for interval shooting.
- To go back to the normal shooting mode, select MENU →  1 (Camera Settings1) → [ Interval Shoot Func.] → [Interval Shooting] → [Off].

- If you press a key to which one of the following functions has been assigned at the moment when shooting starts, the function will remain active during interval shooting even without you holding down the button.
 - [AEL hold]
 - [ AEL hold]
 - [AF/MF Control Hold]
- If you set [Display as Group] to [On], still images shot with the interval shooting function will be displayed in groups.
- Still images shot with interval shooting can be played back continuously on the camera. If you intend to create a movie using the still images, you can preview the result.

Note



- You may not be able to record the set number of images depending on the remaining battery level and the amount of free space on the recording medium. Supply power via USB while shooting, and use a memory card with sufficient space.
- When the shooting interval is short, the camera may get hot easily. Depending on the ambient temperature, you may not be able to record the set number of images because the camera may stop recording to protect the equipment.
- During interval shooting (including the time between pressing the shutter button and the start of shooting), you cannot operate the dedicated shooting setting screen or MENU screen. However, you can adjust some settings such as the shutter speed with using the customized dial or control wheel.
- During interval shooting, auto review is not displayed.
- [Silent Shoot. in Interval] is set to [On] in the default settings, regardless of the setting for [ Silent Shooting].
- Interval shooting is unavailable in the following situations:
 - The shooting mode is set to other than P/A/S/M



Related Topic

- [Imaging Edge](#)
- [Cont. PB for Interval](#)
- [Supplying power from a wall outlet \(wall socket\)](#)

Interchangeable Lens Digital Camera
ILCE-6100 α6100

Recall (Camera Settings1/Camera Settings2)



Allows you to shoot an image after recalling often-used modes or camera settings registered with [**MR**   Memory] in advance.

- 1 Set the mode dial to MR (Memory recall).
- 2 Press the left/right side of the control wheel or turn the control wheel to select the desired number, then press the center of the control wheel.
 - You can also recall registered modes or settings by selecting MENU →  1 (Camera Settings1) → [**MR**   Recall].

Hint

- To recall settings registered to the memory card, set the mode dial to MR (Memory recall), then select the desired number by pressing the left/right side of the control wheel.
- Settings registered to a memory card using another camera of the same model name can be recalled with this camera.

Note

- If you set [**MR**   Recall] after completing the shooting settings, the registered settings are given priority and the original settings may become invalid. Check the indicators on the screen before shooting.





Related Topic

- [Memory \(Camera Settings1/Camera Settings2\)](#)

Interchangeable Lens Digital Camera
ILCE-6100 α6100

Memory (Camera Settings1/Camera Settings2)

Allows you to register up to 3 often-used modes or product settings to the product and up to 4 (M1 through M4) to the memory card. You can recall the settings using just the mode dial.

- 1 Set the product to the setting you want to register.
- 2 MENU →  1 (Camera Settings1) → [  1 /  2 Memory] → desired number.
- 3 Press the center of the control wheel to confirm.

Items that can be registered

- You can register various functions for shooting. The items that can actually be registered are displayed on the menu of the camera.
- Aperture (F number)
- Shutter speed

To change registered settings

Change the setting to the desired one and re-register the setting to the same mode number.

Note

- M1 through M4 can be selected only when a memory card is inserted into the product.
- Program Shift cannot be registered.

Related Topic

- [Recall \(Camera Settings1/Camera Settings2\)](#)

Interchangeable Lens Digital Camera
ILCE-6100 α6100

Focus Mode

Selects the focus method to suit the movement of the subject.

1 MENU →  1 (Camera Settings1) → [Focus Mode] → desired setting.

Menu item details

AF-S (Single-shot AF):

The product locks the focus once focusing is complete. Use this when the subject is motionless.

AF-A (Automatic AF):

[Single-shot AF] and [Continuous AF] are switched according to the movement of the subject. When the shutter button is pressed halfway down, the product locks the focus when it determines that the subject is motionless, or continues to focus when the subject is in motion. During continuous shooting, the product automatically shoots with Continuous AF from the second shot.

AF-C (Continuous AF):

The product continues to focus while the shutter button is pressed and held halfway down. Use this when the subject is in motion. In [Continuous AF] mode, there is no beep when the camera focuses.

DMF (DMF):

You can make fine adjustments manually after performing auto focusing, letting you focus on a subject more quickly than when using the manual focus from the beginning. This is convenient in situations such as macro shooting.

MF (Manual Focus):

Adjusts the focus manually. If you cannot focus on the intended subject using auto focus, use manual focus.

Focus indicator

● (lit):

The subject is in focus and the focus is locked.

● (flashing):

The subject is not in focus.

⊕ (lit):

The subject is in focus. The focus will be adjusted continuously according to the movements of the subject.

⊕ (lit):

Focusing is in progress.

Subjects on which it is difficult to focus using auto focus

- Dark and distant subjects
- Subjects with poor contrast
- Subjects seen through glass
- Fast-moving subjects
- Reflective light or shiny surfaces
- Flashing light
- Back-lit subjects
- Continuously repetitive patterns, such as the facades of buildings
- Subjects in the focusing area with different focal distances

Hint

- In [Continuous AF] mode, you can lock the focus by pressing and holding the button that has been assigned the [Focus Hold] function.

- When you set the focus to infinity in the manual focus mode or the direct manual focus mode, make sure that the focus is on a sufficiently distant subject by checking the monitor or the viewfinder.

Note

- [Automatic AF] is available only when you are using a lens that supports phase detection AF.
- When [Continuous AF] or [Automatic AF] is set, the angle of view may change little by little while focusing. This does not affect the actual recorded images.
- Only [Continuous AF] and [Manual Focus] are available when shooting movies or when the mode dial is set to **S&Q**.

Related Topic

- [Direct manual focus \(DMF\)](#)
- [Manual Focus](#)
- [MF Assist \(still image\)](#)
- [Phase detection AF](#)

Interchangeable Lens Digital Camera
ILCE-6100 α6100

Focus Area

Selects the focusing area. Use this function when it is difficult to focus properly in the auto focus mode.

1 MENU →  1 (Camera Settings1) → [Focus Area] → desired setting.

Menu item details

Wide :

Focuses on a subject covering the whole range of the screen automatically. When you press the shutter button halfway down in the still image shooting mode, a green frame is displayed around the area that is in focus.

Zone :

Select a zone on the monitor on which to focus, and the product will automatically select a focus area.

Center :

Focuses automatically on a subject in the center of the image. Use together with the focus-lock function to create the composition you want.

Flexible Spot :

Allows you to move the focusing frame to a desired point on the screen and focus on an extremely small subject in a narrow area.

Expand Flexible Spot :

If the product cannot focus on a single selected point, it uses focus points around the flexible spot as a secondary priority area for focusing.

Tracking:

When the shutter button is pressed and held halfway down, the product tracks the subject within the selected autofocus area. This setting is available only when the focus mode is set to [Continuous AF]. Point the cursor at [Tracking] on the [Focus Area] setting screen, and then select the desired area to start tracking using the left/right sides of the control wheel. You can also move the tracking start area to the desired point by designating the area as a zone, flexible spot or expand flexible spot.

Examples of the focusing frame display

The focusing frame differs as follows.

When focusing on a larger area

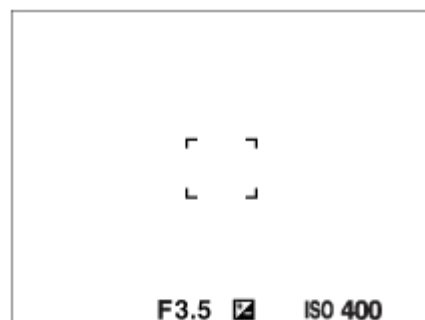

When focusing on a smaller area

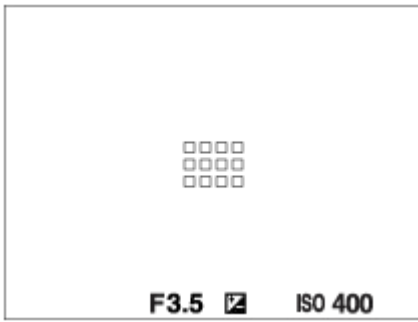

- When [Focus Area] is set to [Wide] or [Zone], the focusing frame may switch between “When focusing on a larger area” and “When focusing on a smaller area” depending on the subject or situation.
- When you attach an A-mount lens with a Mount Adaptor (LA-EA1 or LA-EA3) (sold separately), the focusing frame for “When focusing on a smaller area” may be displayed.

When focus is achieved automatically based on the whole range of the monitor

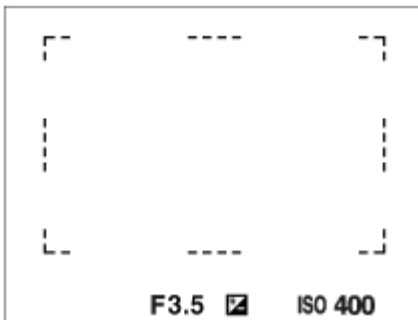

- When you use a zoom function other than the optical zoom, the [Focus Area] setting is disabled and the focusing frame is shown by the dotted line. The AF operates with priority on and around the center area.

To move the focus area

- When [Focus Area] is set to [Zone], [Flexible Spot] or [Expand Flexible Spot], if pressing the button to which [Focus Standard] is assigned, you can shoot while moving the focusing frame using the top/bottom/left/right sides of the control wheel. To return the focusing frame to the center of the monitor, press the  button while moving the frame. To change the shooting settings using the control wheel, press the button to which [Focus Standard] is assigned.
- You can move the focusing frame quickly by touching and dragging it on the monitor. Set [Touch Operation] to [On], and set [Func. of Touch Operation] to [Touch Focus] beforehand.

Note



- [Focus Area] is locked to [Wide] in the following situations:
 - [Intelligent Auto]
 - [Superior Auto]
 - [Scene Selection]
 - During Smile Shutter mode
- The focus area may not light up during continuous shooting or when the shutter button is pressed all the way down at once.
- When the mode dial is set to  (Movie) or **S&Q** or during movie shooting, [Tracking] cannot be selected as the [Focus Area].
- When [Subject Detection] for [Face/Eye AF Set.] is set to [Animal], [Tracking] cannot be selected as the [Focus Area].
- You cannot perform functions assigned to the up/down/left/right sides of the control wheel or the custom button 2 while moving the focusing frame.

Related Topic

Interchangeable Lens Digital Camera
ILCE-6100 α6100

AF Illuminator (still image)

The AF illuminator supplies fill light to focus more easily on a subject in dark surroundings. In the time between pressing the shutter button halfway down and locking the focus, the AF illuminator lights up to allow the camera to focus easily.

1 MENU →  1 (Camera Settings1) → [ AF Illuminator] → desired setting.

Menu item details



Auto:

The AF illuminator lights up automatically in dark surroundings.

Off:

Does not use the AF illuminator.

Note

- You cannot use [ AF Illuminator] in the following situations:
 - When the shooting mode is [Movie] or [S&Q Motion].
 - Sweep Panorama
 - When [Focus Mode] is set to [Continuous AF] or [Automatic AF] and the subject is moving (when the focus indicator  or  lights up).
 - When [Focus Magnifier] is activated.
 - When [Scene Selection] is set to the following modes:
 - [Landscape]
 - [Sports Action]
 - [Night Scene]
 - When a Mount Adaptor is attached.
- If the Multi Interface Shoe is equipped with a flash with an AF illuminator function, when the flash is turned on, the AF illuminator will turn on as well.
- The AF illuminator emits a very bright light. Although there is no health hazard, do not look directly into the AF illuminator at close range.

Interchangeable Lens Digital Camera
ILCE-6100 α6100

Face/Eye AF Set.

This function is used to determine whether or not the camera will focus with priority on faces or eyes.

There are two ways to perform [Eye AF].

- Focusing on the eyes by pressing the shutter button halfway down.
- Focusing on the eyes by pressing the custom key. For details on using the custom key to perform [Eye AF], refer to the explanation below (▼).

1 MENU →  1 (Camera Settings1) → [Face/Eye AF Set.] → desired setting item.

Menu item details

Face/Eye Priority in AF :

Sets whether or not to detect faces or eyes inside the focusing area and focus on the eyes (Eye AF) when autofocus is activated. ([On]/[Off])

(Note: The camera operations are different when using the custom key to execute [Eye AF].)

Subject Detection :

Selects the target to be detected.

[Human]: Detects human faces/eyes.

[Animal]: Detects animal eyes. Animal faces are not detected.

Right/Left Eye Select :

Specifies the eye to be detected when [Subject Detection] is set to [Human]. If [Right Eye] or [Left Eye] is selected, only the selected eye is detected. When [Subject Detection] is set to [Animal], [Right/Left Eye Select] cannot be used.

[Auto]: The camera detects eyes automatically.

[Right Eye]: The right eye of the subject (the eye on the left side from the photographer's perspective) is detected.

[Left Eye]: The left eye of the subject (the eye on the right side from the photographer's perspective) is detected.

Face Detect. Frame Disp. :

Sets whether or not to display the face detection frame when a human face is detected. ([On]/[Off])

Animal Eye Display :

Sets whether or not to display the eye detection frame when the eye of an animal is detected. ([On]/[Off])

Face detection frame

When the product detects a face, the gray face detection frame appears. When the product determines that autofocus is enabled, the face detection frame turns white.

In case you have registered the priority order for each face using [Face Registration], the product automatically selects the first prioritized face and the face detection frame over that face turns white. The face detection frames of other registered faces turn reddish-purple.



Eye detection frame



A white eye detection frame appears when an eye is detected and the camera determines that autofocusing is possible, depending on the settings.

The eye detection frame is displayed as follows when [Subject Detection] is set to [Animal].



[Eye AF] by custom key

The Eye AF function can also be used by assigning [Eye AF] to a custom key. The camera can focus on eyes as long as you are pressing the key. This is useful when you want to temporarily apply the Eye AF function to the entire screen regardless of the setting for [Focus Area]. The camera does not focus automatically if no faces or eyes are detected. (Note: When you try to focus on eyes by pressing the shutter button halfway down, the camera only detects faces or eyes inside the focus area designated with [Focus Area]. If the camera detects no faces or eyes, it performs normal auto-focusing.)

1. MENU →  2 (Camera Settings2) →  Custom Key → desired key, then assign the [Eye AF] function to the key.
2. MENU →  1 (Camera Settings1) → [Face/Eye AF Set.] → [Subject Detection] → desired setting.
3. Point the camera at the face of a human or animal, and press the key to which you have assigned the [Eye AF] function.
4. Press the shutter button while pressing the key.

[Switch Right/Left Eye] by custom key

When [Right/Left Eye Select] is set to [Right Eye] or [Left Eye], you can switch the eye to be detected by pressing the custom key to which you have assigned the [Switch Right/Left Eye] function.

When [Right/Left Eye Select] is set to [Auto], you can temporarily switch the eye to be detected by pressing the custom key to which you have assigned the [Switch Right/Left Eye] function.



The temporary left/right selection is cancelled when you perform the following operations, etc. The camera returns to automatic eye detection.

- Stopping pressing the shutter button halfway down
- Stopping pressing the custom key to which [AF On] or [Eye AF] is assigned
- Pressing the Fn button or MENU button

Hint

- When [Right/Left Eye Select] is not set to [Auto], or you execute [Switch Right/Left Eye] using the custom key, the eye detection frame appears.
- If you want the face or eye detection frame to disappear within a certain period of time after the camera has focused on the face or eye, set [AF Area Auto Clear] to [On].
- To detect animal eyes, arrange the composition so that both eyes and the nose of the animal are within the angle of view. Once you focus on the animal's face, the animal's eyes will be detected more easily.

Note

- When [Subject Detection] is set to [Human], the eyes of animals are not detected. When [Subject Detection] is set to [Animal], human faces are not detected.
- When [Scene Selection] is set to [Portrait], [Face/Eye Priority in AF] is locked to [On], and [Subject Detection] is locked to [Human].
- When [Smile Shutter] is set to [On], [Face/Eye Priority in AF] is locked to [On], and [Subject Detection] is locked to [Human].
- When [Subject Detection] is set to [Animal], the following functions cannot be used.
 - Tracking function
 - Face Priority in Multi Metering
 - Regist. Faces Priority
 -  Soft Skin Effect
- The [Eye AF] function may not function very well in the following situations:
 - When the person is wearing sunglasses.
 - When the front hair covers the person's eyes.
 - In low-light or back-lit conditions.
 - When the eyes are closed.
 - When the subject is in the shade.
 - When the subject is out of focus.
 - When the subject is moving too much.
- If the subject is moving too much, the detection frame may not be displayed correctly over their eyes.
- Depending on the circumstances, the eyes cannot be focused.
- When the camera cannot focus on human eyes, it will detect and focus on the face instead. The camera cannot focus on eyes when no human faces are detected.
- The product may not detect faces at all or may accidentally detect other objects as faces in some conditions.
- The Eye AF function is unavailable when the mode dial is set to  (Movie) or **S&Q**, or during movie shooting.
- The eye detection frame is not displayed when the Eye AF function is unavailable.
- You cannot use the face/eye detection function with the following functions:
 - Zoom functions other than the optical zoom.
 - [Sweep Panorama]
 - [Posterization] under [Picture Effect]
 - Focus Magnifier
 - When [Scene Selection] is set to [Landscape], [Night Scene], or [Sunset]
 - When [**S&Q** Frame Rate] is set to [120fps]/[100fps] during slow-motion/quick-motion shooting.
- You cannot use the face detection function with the following functions:
 - Movie shooting with  Record Setting] set to [120p]/[100p]
- Up to 8 faces of your subjects can be detected.
- Even if [Face Detect. Frame Disp.] or [Animal Eye Display] is set to [Off], a green focusing frame will be displayed over faces or eyes that are in focus.
- When the shooting mode is set to [Intelligent Auto] or [Superior Auto], [Face/Eye Priority in AF] is locked to [On].
- Even when [Subject Detection] is set to [Animal], the eyes of some types of animals cannot be detected.



Related Topic

- [Focus Mode](#)
- [Focus Area](#)
- [AF Area Auto Clear](#)
- [Assigning frequently used functions to buttons \(Custom Key\)](#)

Interchangeable Lens Digital Camera
ILCE-6100 α6100

AF w/ shutter (still image)

Selects whether to focus automatically when you press the shutter button halfway down. Select [Off] to adjust the focus and the exposure separately.

1 MENU →  1 (Camera Settings1) → [ AF w/ shutter] → desired setting.

Menu item details

On:





The auto focus operates when you press the shutter button halfway down.

Off:

The auto focus does not operate even if you press the shutter button halfway down.

Useful method to micro-adjust the focus

When an A-mount lens is attached, activating the auto focus function with a button other than the shutter button lets you focus more precisely in combination with manual focusing.

1. Set [ AF w/ shutter] to [Off].
2. MENU →  2 (Camera Settings2) → [ Custom Key] or [ Custom Key] → assign the [AF On] and [Focus Magnifier] functions to the desired keys.
3. Set [ Eye-Start AF] to [Off] to avoid auto focusing when you look through the viewfinder.
4. Press the key to which the [AF On] function is assigned.
5. Press the key to which the [Focus Magnifier] function is assigned, and then rotate the focus ring for micro-adjustments of the focus.
6. Press the shutter button fully down to shoot the image.

Related Topic

- [AF On](#)
- [Eye-Start AF \(still image\)](#)
- [Pre-AF \(still image\)](#)
- [Focus Magnifier](#)

Interchangeable Lens Digital Camera
ILCE-6100 α6100

Pre-AF (still image)

The product automatically adjusts focus before you press the shutter button halfway down. During focusing operations, the screen may shake.

① MENU →  1 (Camera Settings1) → [ Pre-AF] → desired setting.

Menu item details

On:

Adjusts focus before you press the shutter button halfway down.

Off:

Does not adjust focus before you press the shutter button halfway down.



Note

- [ Pre-AF] is available only when an E-mount lens is mounted.

Interchangeable Lens Digital Camera
ILCE-6100 α6100

Eye-Start AF (still image)

Sets whether or not to use autofocus when you look through an Electronic Viewfinder.

1 MENU →  1 (Camera Settings1) → [ Eye-Start AF] → desired setting.

Menu item details

On:

Auto focusing starts when you look through the Electronic Viewfinder.

Off:

Auto focusing does not start when you look through the Electronic Viewfinder.

Hint

- [ Eye-Start AF] is available when an A-mount lens and a Mount Adaptor (LA-EA2, LA-EA4) (sold separately) are attached.

Interchangeable Lens Digital Camera
ILCE-6100 α6100

AF Area Auto Clear

Sets whether the focus area should be displayed all the time or should disappear automatically shortly after focus is achieved.

① MENU →  1 (Camera Settings1) → [AF Area Auto Clear] → desired setting.

Menu item details

On:

The focus area disappears automatically shortly after focus is achieved.

Off:

The focus area is displayed all the time.

Interchangeable Lens Digital Camera
ILCE-6100 α6100

Disp. cont. AF area

You can set whether or not to display the area that is in focus when [Focus Area] is set to [Wide] or [Zone], in [Continuous AF] mode.

1 MENU →  1 (Camera Settings1) → [Disp. cont. AF area] → desired setting.

Menu item details

On:

Displays the focus area that is in focus.

Off:

Does not display the focus area that is in focus.

Note

- When [Focus Area] is set to one of the following, the focusing frames in the area that is in focus turn green:
 - [Center]
 - [Flexible Spot]
 - [Expand Flexible Spot]

Interchangeable Lens Digital Camera
ILCE-6100 α6100

AF Micro Adj.

Allows you to adjust the auto-focusing position and register an adjusted value for each lens when using A-mount lenses with an LA-EA2 or LA-EA4 Mount Adaptor (sold separately).

Use this function only when adjustments are needed. Note that the auto focus function may not be performed at a proper position when using this adjustment.

1 MENU →  (Camera Settings1) → [AF Micro Adj.].

2 Select [AF Adjustment Set.] → [On].

3 [amount] → desired value.

- The larger the value you select, the farther the autofocused position will be from the product. The smaller the value you select, the closer the autofocused position will be to the product.

Hint

- It is recommended that you adjust the position under actual shooting conditions. Set [Focus Area] to [Flexible Spot] and use a bright subject with high contrast when you adjust.

Note

- When you attach a lens for which you have already registered a value, the registered value appears on the screen. [±0] appears for lenses for which a value has not yet been registered.
- If [-] is displayed as the value, then a total of 30 lenses have been registered and no new lens can be registered. To register a new lens, attach a lens for which the registration can be erased, and set its value to [±0], or reset the values of all the lenses using [Clear].
- The [AF Micro Adj.] supports Sony, Minolta, or Konica-Minolta lenses. If you perform [AF Micro Adj.] with lenses other than the supported lenses, the registered settings for the supported lenses may be affected. Do not perform [AF Micro Adj.] with an unsupported lens.
- You cannot set [AF Micro Adj.] individually for a Sony, Minolta, and Konica-Minolta lens of the same specification.

Interchangeable Lens Digital Camera
ILCE-6100 α6100

Exposure Comp.

Normally, exposure is set automatically (auto exposure). Based on the exposure value set by auto exposure, you can make the entire image brighter or darker if you adjust [Exposure Comp.] to the plus side or minus side, respectively (exposure compensation).

- 1  (Exposure Comp.) on the control wheel → press the left/right side of the control wheel or turn the control wheel, and select the desired setting.

+ (over) side:

Images become brighter.

- (under) side:

Images become darker.

- You can also select MENU →  1 (Camera Settings1) → [Exposure Comp.].
- You can adjust the exposure compensation value within the range of -5.0 EV to +5.0 EV.
- You can confirm the exposure compensation value that you set on the shooting screen.

Monitor

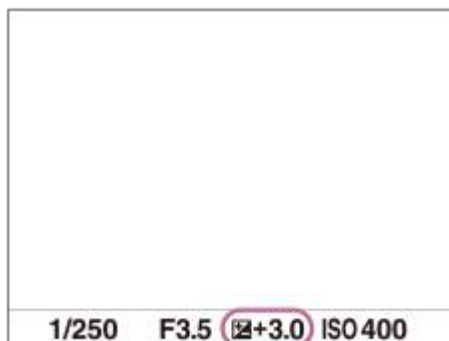

Viewfinder

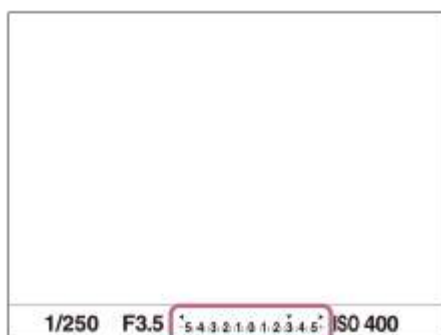

Note

- You cannot perform the exposure compensation in the following shooting modes:
 - [Intelligent Auto]
 - [Superior Auto]
 - [Scene Selection]
- When using [Manual Exposure], you can perform the exposure compensation only when [ISO] is set to [ISO AUTO].

- Only a value between -3.0 EV and +3.0 EV with the equivalent image brightness appears on the screen when shooting. If you set an exposure compensation value outside this range, the image brightness on the screen will not be affected, but the value will be reflected in the recorded image.
- You can adjust the exposure compensation value within the range of -2.0 EV to +2.0 EV for movies.
- If you shoot a subject in extremely bright or dark conditions, or when you use the flash, you may not be able to get a satisfactory effect.

Related Topic

- [Exposure step](#)
- [Exp.comp.set](#)
- [Cont. Bracket](#)
- [Single Bracket](#)
- [Zebra Setting](#)

Interchangeable Lens Digital Camera
ILCE-6100 α6100

ISO

Sensitivity to light is expressed by the ISO number (recommended exposure index). The larger the number, the higher the sensitivity.

1 ISO (ISO) on the control wheel → select desired setting.

- You can also select MENU →  1 (Camera Settings1) → [ISO].
- You can change the value by 1/3 EV steps by turning the control wheel. You can change the value by 1 EV steps by turning the control dial.

Menu item details

Multi Frame NR:

Combines continuous shots to create an image with less noise. Press the right side to display the setting screen, then select a desired value using the top/bottom sides of the control wheel.

Select the desired ISO number from ISO AUTO or ISO 100 – ISO 51200.

ISO AUTO:

Sets the ISO sensitivity automatically.

ISO 100 – ISO 51200:

Sets the ISO sensitivity manually. Selecting a larger number increases the ISO sensitivity.

Hint

- You can change the range of ISO sensitivity that is set automatically in [ISO AUTO] mode. Select [ISO AUTO] and press the right side of the control wheel, and set the desired values for [ISO AUTO Maximum] and [ISO AUTO Minimum]. The values are also applied when shooting in [ISO AUTO] mode under [Multi Frame NR].
- You can set the effect level for noise reduction by selecting [NR Effect] under [Multi Frame NR].

Note

- When [ File Format] is set to [RAW] or [RAW & JPEG], [Multi Frame NR] cannot be selected.
- When [Multi Frame NR] is selected, the flash, [D-Range Optimizer], or [Auto HDR] cannot be used.
- When [Picture Effect] is set to other than [Off], [Multi Frame NR] cannot be selected.
- [ISO AUTO] is selected when using the following functions:
 - [Intelligent Auto]
 - [Superior Auto]
 - [Scene Selection]
 - [Sweep Panorama]
- The higher the ISO value, the more noise will appear on the images.
- The available ISO settings will differ depending on whether you are shooting still images, shooting movies, or shooting slow-motion/quick-motion movies.
- When shooting movies, ISO values between 100 and 32000 are available. If the ISO value is set to a value larger than 32000, the setting is automatically switched to 32000. When you finish recording the movie, the ISO value returns to the original setting.
- When you use [Multi Frame NR], it takes some time for the product to perform the overlay processing of images.

- When you select [ISO AUTO] with the shooting mode set to [P], [A], [S] or [M], the ISO sensitivity will be automatically adjusted within the set range.

Metering Mode

Selects the metering mode that sets which part of the screen to measure for determining the exposure.

1 MENU →  (Camera Settings1) → [Metering Mode] → desired setting.

Menu item details

 **Multi:**

Measures light on each area after dividing the total area into multiple areas and determines the proper exposure of the entire screen (Multi-pattern metering).

 **Center:**

Measures the average brightness of the entire screen, while emphasizing the central area of the screen (Center-weighted metering).

 **Spot:**

Measures only the central area (Spot metering). This mode is suitable for measuring light on the back-lit subject or when the contrast of the background and the subject is strong.

Hint

- When [Multi] is selected and [Face Priority in Multi Metering] is set to [On], the camera measures brightness based on detected faces.

Note

- [Metering Mode] is locked to [Multi] in the following shooting modes:
 - [Intelligent Auto]
 - [Superior Auto]
 - [Scene Selection]
 - Other zoom functions than the optical zoom

Related Topic

- [AE lock](#)
- [Face Priority in Multi Metering](#)
- [D-Range Optimizer \(DRO\)](#)
- [Auto HDR](#)

Interchangeable Lens Digital Camera
ILCE-6100 α6100

Face Priority in Multi Metering

Sets whether the camera measures brightness based on detected faces when [Metering Mode] is set to [Multi].

1 MENU →  1 (Camera Settings1) → [Face Priority in Multi Metering] → desired setting.

Menu item details

On:

The camera measures brightness based on detected faces.

Off:

The camera measures brightness using the [Multi] setting, without detecting faces.

Note

- When the shooting mode is set to [Intelligent Auto] or [Superior Auto], [Face Priority in Multi Metering] is locked to [On].
- When [Face/Eye Priority in AF] is set to [On] and [Subject Detection] is set to [Animal] under [Face/Eye AF Set.], [Face Priority in Multi Metering] does not work.

Related Topic

- [Metering Mode](#)

Interchangeable Lens Digital Camera
ILCE-6100 α6100

Exposure step

You can adjust the setting increment for the shutter speed, aperture, and exposure compensation values.

1 MENU →  1 (Camera Settings1) → [Exposure step] → desired setting.



Menu item details

0.3EV / 0.5EV

Interchangeable Lens Digital Camera
ILCE-6100 α6100

AEL w/ shutter (still image)

Sets whether to fix the exposure when you press the shutter button halfway down.
Select [Off] to adjust the focus and the exposure separately.

1 MENU →  1 (Camera Settings1) → [ AEL w/ shutter] → desired setting.

Menu item details

Auto:

Fixes the exposure after adjusting the focus automatically when you press the shutter button halfway down when [Focus Mode] is set to [Single-shot AF]. When [Focus Mode] is set to [Automatic AF], and the product determines that the subject is moving, or you shoot burst images, the fixed exposure is cancelled.

On:

Fixes the exposure when you press the shutter button halfway down.

Off:

Does not fix the exposure when you press the shutter button halfway down. Use this mode when you want to adjust focus and exposure separately.

The product keeps adjusting the exposure while shooting in [Cont. Shooting] mode.

Note

- Operation using the AEL button is prioritized over the [ AEL w/ shutter] settings.

Flash Mode

You can set the flash mode.

1 MENU →  1 (Camera Settings1) → [Flash Mode] → desired setting.

Menu item details

 **Flash Off:**

The flash does not operate.

 **Autoflash:**

The flash works in dark environments or when shooting towards bright light.

 **Fill-flash:**

The flash works every time you trigger the shutter.

 **Slow Sync.:**

The flash works every time you trigger the shutter. Slow sync shooting allows you to shoot a clear image of both the subject and the background by slowing the shutter speed.

 **Rear Sync.:**

The flash works right before the exposure is completed every time you trigger the shutter. Rear sync shooting allows you to shoot a natural image of the trail of a moving subject such as a moving car or a walking person.

Note

- The default setting depends on the shooting mode.
- Some [Flash Mode] settings are not available, depending on the shooting mode.

Related Topic

- [Using flash](#)
- [Wireless Flash](#)

Flash Comp.

Adjusts the amount of flash light in a range of -3.0 EV to +3.0 EV. Flash compensation changes the amount of flash light only. Exposure compensation changes the amount of flash light along with the change of the shutter speed and aperture.

1 MENU →  1 (Camera Settings1) → [Flash Comp.] → desired setting.

- Selecting higher values (+ side) makes the flash level higher, and lower values (- side) makes the flash level lower.

Note

- [Flash Comp.] does not work when the shooting mode is set to the following modes:
 - [Intelligent Auto]
 - [Superior Auto]
 - [Sweep Panorama]
 - [Scene Selection]
- The higher flash effect (+ side) may not be visible due to the limited amount of flash light available, if the subject is outside the maximum range of the flash. If the subject is very close, the lower flash effect (- side) may not be visible.
- If you attach an ND filter to the lens or attach a diffuser or a color filter to the flash, the appropriate exposure may not be achieved and images may turn out dark. In this case, adjust [Flash Comp.] to the desired value.

Related Topic

- [Using flash](#)

Interchangeable Lens Digital Camera
ILCE-6100 α6100

Exp.comp.set

Sets whether to apply the exposure compensation value to control both flash light and ambient light, or just ambient light.

① MENU →  1 (Camera Settings1) → [Exp.comp.set] → desired setting.

Menu item details

Ambient&flash:

Applies the exposure compensation value to control both flash light and ambient light.

Ambient only:

Applies the exposure compensation value to control ambient light only.

Related Topic

- [Flash Comp.](#)

Interchangeable Lens Digital Camera
ILCE-6100 α6100

Wireless Flash

There are two methods for wireless flash shooting: light-signal flash shooting that uses the light of the flash attached to the camera as a signal light, and radio-signal flash shooting that uses wireless communication. To perform radio-signal flash shooting, use a compatible flash or the Wireless Radio Commander (sold separately). For details on how to set each method, refer to the instruction manual of the flash or the Wireless Radio Commander.

- 1 **MENU** →  1 (Camera Settings1) → [Wireless Flash] → [On].
- 2 **Remove the shoe cap from the camera, and then attach the flash or the Wireless Radio Commander.**
 - When performing light-signal wireless flash shooting, set the attached flash as the controller.
When performing radio-signal wireless flash shooting with a flash attached to the camera, set the attached flash as the commander.
- 3 **Set up an off-camera flash that is set to wireless mode, or that is attached to the Wireless Radio Receiver (sold separately).**
 - Press the AEL button on the camera to perform a test flashing.

Menu item details



Off:

Does not use the wireless flash function.

On:

Uses the wireless flash function to make an external flash or flashes emit light at a distance from the camera.

Setting of the AEL button

We recommend that you set **MENU** →  2 (Camera Settings2) → [ Custom Key] → [AEL Button] to [AEL hold] when performing wireless flash shooting.

Note

- Wireless flash shooting cannot be performed with the camera's built-in flash.
- The off-camera flash may emit light after receiving a light signal from a flash used as the controller of another camera. If this occurs, change the channel of your flash. For details on how to change the channel, refer to the instruction manual for the flash.
- For the flash that is compatible with wireless flash shooting, visit the Sony website, or consult your Sony dealer or local authorized Sony service facility.

Interchangeable Lens Digital Camera
ILCE-6100 α6100

Red Eye Reduction

When using the flash, it is fired two or more times before shooting to reduce the red-eye phenomenon.

1 MENU →  1 (Camera Settings1) → [Red Eye Reduction] → **desired setting.**

Menu item details

On:

The flash is always fired to reduce the red-eye phenomenon.

Off:

Does not use Red Eye Reduction.

Note

- Red Eye Reduction may not produce the desired effects. It depends on individual differences and conditions, such as distance to the subject, or whether the subject looks at the pre-strobe or not.













Interchangeable Lens Digital Camera
ILCE-6100 α6100

White Balance

Corrects the tone effect of the ambient light condition to record a neutral white subject in white. Use this function when the color tones of the image did not come out as you expected, or when you want to change the color tones on purpose for photographic expression.

1 MENU →  1 (Camera Settings1) → [White Balance] → desired setting.

Menu item details

AWB   Auto /  Daylight /  Shade /  Cloudy /  Incandescent /  -1 Fluor.: Warm White /  0 Fluor.: Cool White /  +1 Fluor.: Day White /  +2 Fluor.: Daylight /  Flash /  Underwater Auto :

When you select a light source that illuminates the subject, the product adjusts the color tones to suit to the selected light source (preset white balance). When you select [Auto], the product automatically detects the light source and adjusts the color tones.



C.Temp./Filter:

Adjusts the color tones depending on the light source. Achieves the effect of CC (Color Compensation) filters for photography.

Custom 1/Custom 2/Custom 3:

Memorizes the basic white color under the light conditions for the shooting environment.

Hint

- You can display the fine adjustment screen and perform fine adjustments of the color tones as required by pressing the right side of the control wheel. When [C.Temp./Filter] is selected, you can change the color temperature by turning the control dial instead of pressing the right side of the control wheel.
- If the color tones do not come out as you expected in the selected settings, perform [WB bracket] shooting.
-  or  is displayed only when [Priority Set in AWB] is set to [Ambience] or [White].

Note

- [White Balance] is fixed to [Auto] in the following shooting modes:
 - [Intelligent Auto]
 - [Superior Auto]
 - [Scene Selection]
- If you use a mercury lamp or a sodium lamp as a light source, the accurate white balance will not be obtained because of the characteristics of the light. It is recommended to shoot images using a flash or select [Custom 1] to [Custom 3].

Related Topic

- [Capturing a standard white color to set the white balance \(custom white balance\)](#)
- [Priority Set in AWB](#)
- [WB bracket](#)

Interchangeable Lens Digital Camera
ILCE-6100 α6100

Priority Set in AWB

Selects which tone to prioritize when shooting under lighting conditions such as incandescent light when [White Balance] is set to [Auto].

① MENU →  1 (Camera Settings1) → [Priority Set in AWB] → desired setting.

Menu item details

AWB
STD **Standard:**

Shoots with standard auto white balance. The camera automatically adjusts the color tones.

AWB
Ambi **Ambience:**

Prioritizes the color tone of the light source. This is suitable when you want to produce a warm atmosphere.

AWB
White **White:**

Prioritizes a reproduction of white color when the color temperature of the light source is low.

Related Topic

- [White Balance](#)

Interchangeable Lens Digital Camera
ILCE-6100 α6100

D-Range Optimizer (DRO)

By dividing the image into small areas, the product analyzes the contrast of light and shadow between the subject and the background, and creates an image with the optimal brightness and gradation.

1 MENU →  1 (Camera Settings1) → [DRO/Auto HDR] → [D-Range Optimizer].

2 Select the desired setting using the left/right sides of the control wheel.

Menu item details

D-Range Optimizer: Auto:

Corrects the brightness automatically.

D-Range Optimizer: Lv1 — D-Range Optimizer: Lv5:

Optimizes the gradation of a recorded image for each divided area. Select the optimization level from Lv1 (weak) to Lv5 (strong).

Note

- In the following situations, [DRO/Auto HDR] is fixed to [Off]:
 - The shooting mode is set to [Sweep Panorama].
 - Multi Frame NR
 - When [Picture Effect] is set to other than [Off]
- [DRO/Auto HDR] is fixed to [Off] when the following modes are selected in [Scene Selection].
 - [Sunset]
 - [Night Scene]
 - [Night Portrait]
 - [Hand-held Twilight]
 - [Anti Motion Blur]

The setting is fixed to [D-Range Optimizer: Auto] when [Scene Selection] modes other than the above modes are selected.

- When shooting with [D-Range Optimizer], the image may be noisy. Select the proper level by checking the recorded image, especially when you enhance the effect.

Auto HDR

Shoots three images using different exposures and combines the images with correct exposure, the bright parts of an underexposed image, and the dark parts of an overexposed image to create images with a greater range of gradation (High Dynamic Range). One image with proper exposure and one overlaid image are recorded.

- 1 **MENU** →  **1 (Camera Settings1)** → **[DRO/Auto HDR]** → **[Auto HDR]**.
- 2 **Select the desired setting using the left/right sides of the control wheel.**

Menu item details

 **Auto HDR: Exposure Diff. Auto:**
Corrects the brightness automatically.

 **Auto HDR: Exposure Diff. 1.0EV — Auto HDR: Exposure Diff. 6.0EV:**



Sets the exposure difference, based on the contrast of the subject. Select the optimization level from 1.0EV (weak) to 6.0EV (strong).

For example, if you set the exposure value to 2.0 EV, three images will be composed with the following exposure levels: -1.0 EV, correct exposure and +1.0 EV.

Hint

- The shutter is released three times for one shot. Be careful about the following:
 - Use this function when the subject is motionless or does not flash light.
 - Do not change the composition before shooting.





Note

- This function is not available when the [ File Format] is [RAW] or [RAW & JPEG].
- [Auto HDR] is not available in the following shooting modes:
 - [Intelligent Auto]
 - [Superior Auto]
 - [Sweep Panorama]
 - [Scene Selection]
- [Auto HDR] is not available in the following situations:
 - When [Multi Frame NR] is selected.
 - When [Picture Effect] is set to other than [Off].
- You cannot start the next shot until the capture process is completed after you shoot.
- You may not obtain the desired effect depending on the luminance difference of a subject and the shooting conditions.
- When the flash is used, this function has little effect.
- When the contrast of the scene is low or when product shake or subject blur occurs, you may not obtain good HDR images.   will be displayed over the recorded image to inform you when the camera detects image blurring. Change the composition or re-shoot the image carefully to avoid image blur, as needed.

Interchangeable Lens Digital Camera
ILCE-6100 α6100

Creative Style

Allows you to set the desired image processing and finely adjust contrast, saturation and sharpness for each image style. You can adjust exposure (shutter speed and aperture) as you like with this function, unlike with [Scene Selection], where the product adjusts the exposure.

- 1 MENU →  1 (Camera Settings1) → [Creative Style].
- 2 Select the desired style using the top/bottom sides of the control wheel.
- 3 To adjust ,  (Saturation) and  (Sharpness), select the desired item using the right/left sides, and then select the value using the top/bottom sides.

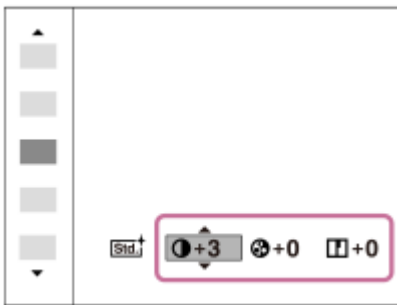

Menu item details

Standard:

For shooting various scenes with rich gradation and beautiful colors.

Vivid:

The saturation and contrast are heightened for shooting striking images of colorful scenes and subjects such as flowers, spring greenery, blue sky, or ocean views.

Portrait:

For capturing skin in a soft tone, ideally suited for shooting portraits.

Landscape:

The saturation, contrast, and sharpness are heightened for shooting vivid and crisp scenery. Distant landscapes also stand out more.

Sunset:

For shooting the beautiful red of the setting sun.

Black & White:

For shooting images in black and white monotone.

Sepia:

For shooting images in sepia monotone.

To set [Contrast], [Saturation] and [Sharpness]

[Contrast], [Saturation], and [Sharpness] can be adjusted for each image style preset such as [Standard] and [Landscape].

Select an item to be set by pressing the right/left sides of the control wheel, then set the value using the top/bottom sides of the control wheel.

Contrast:

The higher the value selected, the more the difference of light and shadow is accentuated, and the bigger the effect on the image.

Saturation:

The higher the value selected, the more vivid the color. When a lower value is selected, the color of the image is restrained and subdued.

Sharpness:

Adjusts the sharpness. The higher the value selected, the more the contours are accentuated, and the lower the value selected, the more the contours are softened.

Note

- [Creative Style] is fixed to [Standard] in the following situations:
 - [Intelligent Auto]
 - [Superior Auto]
 - [Scene Selection]
 - [Picture Effect] is set to other than [Off].

- When this function is set to [Black & White] or [Sepia], [Saturation] cannot be adjusted.

Interchangeable Lens Digital Camera
ILCE-6100 α6100

Picture Effect

Select the desired effect filter to achieve more impressive and artistic images.

1 MENU →  1 (Camera Settings1) → [Picture Effect] → desired setting.

Menu item details

 **Off:**

Disables the [Picture Effect] function.

 **Toy Camera:**

Creates a soft image with shaded corners and reduced sharpness.

 **Pop Color:**

Creates a vivid look by emphasizing color tones.

 **Posterization:**

Creates a high contrast, abstract look by heavily emphasizing primary colors, or in black and white.

 **Retro Photo:**

Creates the look of an aged photo with sepia color tones and faded contrast.

 **Soft High-key:**

Creates an image with the indicated atmosphere: bright, transparent, ethereal, tender, soft.

 **Partial Color:**

Creates an image which retains a specific color, but converts others to black and white.

 **High Contrast Mono.:**

Creates a high-contrast image in black and white.

 **Soft Focus:**

Creates an image filled with a soft lighting effect.

 **HDR Painting:**

Creates the look of a painting, enhancing the colors and details.

 **Rich-tone Mono.:**

Creates an image in black and white with rich gradation and reproduction of details.

 **Miniature:**

Creates an image which enhances the subject vividly, with the background defocused considerably. This effect may often be found in pictures of miniature models.

 **Watercolor:**

Creates an image with ink bleed and blurring effects as if painted using watercolors.

 **Illustration:**

Creates an illustration-like image by emphasizing the outlines.

Hint

- You can perform detailed settings for some items using the left/right sides of the control wheel.

Note

- When you use a zoom function other than the optical zoom, setting the zoom scale larger makes [Toy Camera] less effective.
- When [Partial Color] is selected, images may not retain the selected color, depending on the subject or shooting conditions.
- You cannot check the following effects on the shooting screen, because the product processes the image after the shot. Also, you cannot shoot another image until image processing is finished. You cannot use these effects with movies.

- [Soft Focus]
 - [HDR Painting]
 - [Rich-tone Mono.]
 - [Miniature]
 - [Watercolor]
 - [Illustration]
- In the case of [HDR Painting] and [Rich-tone Mono.], the shutter is released three times for one shot. Be careful about the following:
 - Use this function when the subject is motionless or does not flash light.
 - Do not change the composition during shooting.



When the contrast of the scene is low or when significant camera-shake or subject blur has occurred, you may not be able to obtain good HDR images. If the product detects such a situation,  appear on the recorded image to inform you of this situation. Change the composition or re-shoot the image carefully to avoid image blur, as needed.

- This function is not available in the following shooting modes:
 - [Intelligent Auto]
 - [Superior Auto]
 - [Scene Selection]
 - [Sweep Panorama]
- When [ File Format] is set to [RAW] or [RAW & JPEG], this function is not available.

Interchangeable Lens Digital Camera
ILCE-6100 α6100

Soft Skin Effect (still image)

Sets the effect used for shooting the skin smoothly in the Face Detection function.

1 MENU →  1 (Camera Settings1) → [ Soft Skin Effect] → desired setting.

Menu item details

 Off:

Does not use the [ Soft Skin Effect] function.





 On:

Uses the [ Soft Skin Effect].

Hint

- When [ Soft Skin Effect] is set to [On], you can select the effect level. Select the effect level by pressing the right/left side of the control wheel.

Note









- [ Soft Skin Effect] is not available when [ File Format] is [RAW].
- [ Soft Skin Effect] is not available for RAW images when the [ File Format] is [RAW & JPEG].

Interchangeable Lens Digital Camera
ILCE-6100 α6100

Focus Magnifier

You can check the focus by enlarging the image before shooting.

Unlike with [ MF Assist], you can magnify the image without operating the focus ring.

- 1 **MENU** →  1 (Camera Settings1) → [**Focus Magnifier**].
- 2 **Press the center of the control wheel to enlarge the image and select the area you want to enlarge using top/bottom/left/right side of the control wheel.**
 - Each time you press the center, the magnification scale will change.
 - You can set the initial magnification by selecting MENU →  1 (Camera Settings1) → [ Initial Focus Mag.].
- 3 **Confirm the focus.**
 - Press the  (Delete) button to bring the magnified position into the center of an image.
 - When the focus mode is [Manual Focus], you can adjust the focus while an image is magnified. If [ AF in Focus Mag.] is set to [Off], the [Focus Magnifier] function is canceled when the shutter button is pressed halfway down.
 - When the shutter button is pressed halfway down while an image is magnified during the auto-focusing, different functions are performed depending on the [ AF in Focus Mag.] setting.
 - When [ AF in Focus Mag.] is set to [On]: Auto-focusing is performed again.
 - When [ AF in Focus Mag.] is set to [Off]: The [Focus Magnifier] function is canceled.
 - You can set how long the image is to be shown magnified by selecting MENU →  1 (Camera Settings1) → [Focus Magnif. Time].
- 4 **Press the shutter button fully down to shoot the image.**

To use the focus magnifier function by touch operation

You can magnify the image and adjust the focus by touching the monitor. Set [Touch Operation] to [On] beforehand.

Then, select the appropriate settings under [Touch Panel/Pad]. When the focus mode is [Manual Focus], you can perform [Focus Magnifier] by double-tapping the area to focus on while shooting with the monitor.

While shooting with the viewfinder, a frame is displayed in the center of the monitor by double-tapping and you can move the frame by dragging it. The image is magnified by pressing the center of the control wheel.

Hint

- While using the focus magnifier function, you can move the magnified area by dragging it on the touch panel.
- To exit the focus magnifier function, double-tap the monitor again. When [ AF in Focus Mag.] is set to [Off], the focus magnifier function is ended by pressing the shutter button halfway down.

Related Topic

- [MF Assist \(still image\)](#)

- Focus Magnif. Time
- Initial Focus Mag. (still image)
- AF in Focus Mag. (still image)
- Touch Operation

5-009-879-12(1) Copyright 2019 Sony Corporation

Interchangeable Lens Digital Camera
ILCE-6100 α6100

Focus Magnif. Time

Set the duration for which an image is to be magnified using the [ MF Assist] or [Focus Magnifier] function.

① MENU →  1 (Camera Settings1) → [Focus Magnif. Time] → desired setting.

Menu item details

2 Sec:

Magnifies the images for 2 seconds.

5 Sec:

Magnifies the images for 5 seconds.

No Limit:

Magnifies the images until you press the shutter button.



Related Topic

- [Focus Magnifier](#)
- [MF Assist \(still image\)](#)

Interchangeable Lens Digital Camera
ILCE-6100 α6100

Initial Focus Mag. (still image)

Sets the initial magnification scale when using [Focus Magnifier]. Select a setting that will help you frame your shot.

1 MENU →  1 (Camera Settings1) → [ Initial Focus Mag.] → **desired setting.**

Menu item details

x1.0:

Displays the image with the same magnification as the shooting screen.

x5.9:

Displays a 5.9-times enlarged image.



Related Topic

- [Focus Magnifier](#)

Interchangeable Lens Digital Camera
ILCE-6100 α6100

AF in Focus Mag. (still image)





You can focus on the subject more accurately using auto-focus by magnifying the area where you want to focus. While the magnified image is displayed, you can focus on a smaller area than the flexible spot.

- 1 MENU →  1 (Camera Settings1) → [ AF in Focus Mag.] → [On].
- 2 MENU →  1 (Camera Settings1) → [Focus Magnifier].
- 3 **Magnify the image by pressing the center of the control wheel, and then adjust the position using top/bottom/right/left of the control wheel.**
 - The magnification scale changes each time you press the center.
- 4 **Press the shutter button halfway down to focus.**
 - The focus will be achieved at point of + in the center of the screen.
- 5 **Press the shutter button all the way down to shoot.**
 - The camera exits the magnified display after shooting.

Hint

- Use of a tripod is recommended to accurately identify the location you want to magnify.
- You can check the auto-focusing result by magnifying the displayed image. If you want to readjust the focus position, adjust the focus area on the magnified screen and then press the shutter button halfway down.

Note

- If you enlarge an area at the edge of the screen, the camera may not be able to focus.
- The exposure and white balance cannot be adjusted while the displayed image is being magnified.
- [ AF in Focus Mag.] is unavailable in the following situations:
 - In [Sweep Panorama] mode
 - During movie shooting
 - When [Focus Mode] is set to [Continuous AF].
 - When [Focus Mode] is set to [Automatic AF] and the shooting mode is set to other than P/A/S/M.
 - When [Focus Mode] is set to [Automatic AF] and [Drive Mode] is set to [Cont. Shooting].
 - When using a Mount Adaptor (sold separately).
- While the displayed image is being magnified, the following functions are unavailable:
 - [Eye AF]
 - [ Eye-Start AF]
 - [ Pre-AF]
 - [Face/Eye Priority in AF]
 - [ Auto Object Framing]

Related Topic

- [Focus Magnifier](#)

5-009-879-12(1) Copyright 2019 Sony Corporation

Interchangeable Lens Digital Camera
ILCE-6100 α6100

MF Assist (still image)

Enlarges the image on the screen automatically to make manual focusing easier. This works in Manual Focus or Direct Manual Focus shooting.

1 MENU →  1 (Camera Settings1) → [ MF Assist] → [On].



2 Turn the focus ring to adjust the focus.

- The image is enlarged. You can magnify images further by pressing the center of the control wheel.

Hint

- You can set how long the image is to be shown magnified by selecting MENU →  1 (Camera Settings1) → [Focus Magnif. Time].

Note

- You cannot use [ MF Assist] when shooting movies. Use the [Focus Magnifier] function instead.
- [ MF Assist] is not available when a Mount Adaptor is attached. Use the [Focus Magnifier] function instead.

Related Topic

- [Manual Focus](#)
- [Direct manual focus \(DMF\)](#)
- [Focus Magnif. Time](#)

Interchangeable Lens Digital Camera
ILCE-6100 α6100

Peaking Setting

Sets the peaking function, which enhances the outline of in-focus areas during shooting with Manual Focus or Direct Manual Focus.

① MENU →  1 (Camera Settings1) → [Peaking Setting] → desired setting.

Menu item details

Peaking Display:

Sets whether to display peaking.

Peaking Level:

Sets the level of enhancement of in-focus areas.

Peaking Color:

Sets the color used to enhance in-focus areas.

Note

- Since the product recognizes sharp areas as in focus, the effect of peaking differs, depending on the subject and lens.
- The outline of in-focus ranges is not enhanced on devices connected via HDMI.

Related Topic

- [Manual Focus](#)
- [Direct manual focus \(DMF\)](#)

Interchangeable Lens Digital Camera
ILCE-6100 α6100

Face Registration (New Registration)

If you register faces in advance, the product can focus on the registered face as a priority.

- 1 MENU →  1 (Camera Settings1) → [Face Registration] → [New Registration].
- 2 Align the guide frame with the face to be registered, and press the shutter button.
- 3 When a confirmation message appears, select [Enter].

Note

- Up to eight faces can be registered.
- Shoot the face from the front in a brightly lit place. The face may not be registered correctly if it is obscured by a hat, a mask, sunglasses, etc.

Related Topic

- [Regist. Faces Priority](#)
- [Smile Shutter](#)

Interchangeable Lens Digital Camera
ILCE-6100 α6100

Face Registration (Order Exchanging)

When multiple faces are registered to be given priority, the face registered first will be given priority. You can change the priority order.

- 1 MENU →  1 (Camera Settings1) → [Face Registration] → [Order Exchanging].
 - 2 Select a face to change the order of priority.
 - 3 Select the destination.
-

Related Topic

- [Regist. Faces Priority](#)
- [Smile Shutter](#)

Interchangeable Lens Digital Camera
ILCE-6100 α6100

Face Registration (Delete)

Deletes a registered face.

1 MENU →  1 (Camera Settings1) → [Face Registration] → [Delete].

If you select [Delete All], you can delete all registered faces.

Note

- Even if you execute [Delete], the data for registered face will remain in the product. To delete the data for registered faces from the product, select [Delete All].

Interchangeable Lens Digital Camera
ILCE-6100 α6100

Regist. Faces Priority

Sets whether to focus with higher priority on faces registered using [Face Registration].

1 MENU →  1 (Camera Settings1) → [Regist. Faces Priority] → desired setting.

Menu item details

On:

Focuses with higher priority on faces registered using [Face Registration].

Off:

Focuses without giving higher priority to registered faces.

Hint

- To use the [Regist. Faces Priority] function, set as follows.
 - [Face/Eye Priority in AF] under [Face/Eye AF Set.]: [On]
 - [Subject Detection] under [Face/Eye AF Set.]: [Human]

Related Topic

- [Face/Eye AF Set.](#)
- [Face Registration \(New Registration\)](#)
- [Face Registration \(Order Exchanging\)](#)

Interchangeable Lens Digital Camera
ILCE-6100 α6100

Smile Shutter

The camera automatically shoots an image when it detects a smiling face.

1 MENU →  1 (Camera Settings1) → [Smile Shutter] → desired setting.

Menu item details

Off:

Does not use the [Smile Shutter] function.

On:

The camera automatically shoots an image when it detects a smiling face. You can select [On: Slight Smile], [On: Normal Smile], or [On: Big Smile] for the sensitivity of detection.

Tips for capturing smiles more effectively

- Do not cover the eyes with front hair and keep the eyes narrowed.
- Do not obscure the face by a hat, masks, sunglasses, etc.
- Try to orient the face in front of the product and be as level as possible.
- Give a clear smile with an open mouth. The smile is easier to be detected when the teeth are shown.
- If you press the shutter button during Smile Shutter, the product shoots the image. After shooting, the product returns to Smile Shutter mode.

Note

- You cannot use the [Smile Shutter] function with the following functions:
 - [Sweep Panorama]
 - [Picture Effect]
 - When using the [Focus Magnifier] function.
 - [Scene Selection] is set to [Landscape], [Night Scene], [Sunset], [Hand-held Twilight] or [Anti Motion Blur].
 - When recording movies.
 - During slow-motion/quick-motion shooting.
- Up to 8 faces of your subjects can be detected.
- The product may not detect faces at all or may accidentally detect other objects as faces in some conditions.
- If the product cannot detect a smile, adjust the Smile Detection Sensitivity.
- If [Func. of Touch Operation] is set to [Touch Tracking] and you touch a face on the monitor to track while [Smile Shutter] is active, smile detection will only apply to that face.

Interchangeable Lens Digital Camera
ILCE-6100 α6100

Auto Object Framing (still image)

When this product detects and shoots faces, macro shooting subjects or subjects that are tracked by [Tracking], the product automatically trims the image into an appropriate composition, and then saves it. Both the original and the trimmed images are saved. The trimmed image is recorded in the same size as the original image size.

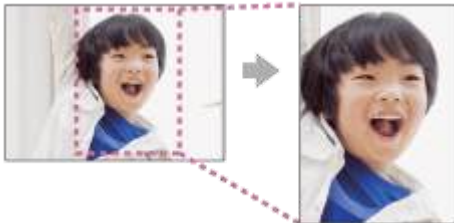

1 MENU → 1 (Camera Settings1) → Auto Object Framing → desired setting.

Menu item details

Off:

Does not trim images.

Auto:

Automatically trims images into an appropriate composition.

Note

- The trimmed image may not be the best possible composition, depending on the shooting conditions.
- [Auto Object Framing] cannot be set when [File Format] is set to [RAW] or [RAW & JPEG].
- [Auto Object Framing] is not available in the following situations.
 - The shooting mode is set to [Sweep Panorama]
 - The shooting mode is set to [Movie]
 - The shooting mode is set to [S&Q Motion]
 - The shooting mode is set to [Hand-held Twilight], [Sports Action], [Anti Motion Blur] in [Scene Selection]
 - [Drive Mode] is set to [Cont. Shooting], [Self-timer(Cont)], [Cont. Bracket], [Single Bracket], [WB bracket], or [DRO Bracket].
 - The ISO sensitivity is set to [Multi Frame NR].
 - [DRO/Auto HDR] is set to [Auto HDR].
 - Other zoom functions than the optical zoom
 - When shooting in Manual Focus mode
 - [Picture Effect] is set to [Soft Focus], [HDR Painting], [Rich-tone Mono.], [Miniature], [Watercolor], or [Illustration].

Interchangeable Lens Digital Camera
ILCE-6100 α6100

Self-portrait/ -timer

You can change the angle of the monitor and shoot images while watching the monitor.

1 MENU →  1 (Camera Settings1) → [Self-portrait/ -timer] → [On].

2 Tilt the monitor approximately 180° upward, and then point the lens at yourself.

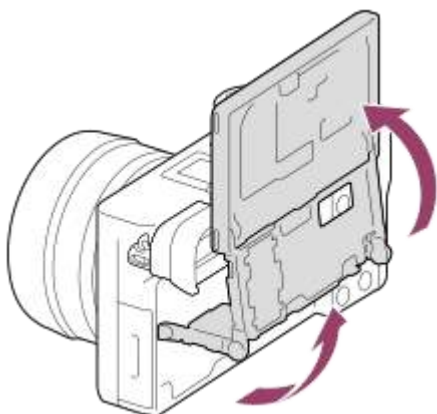

3 Press the shutter button. Alternatively, touch the subject on the monitor.

The product starts the self-timer shooting after three seconds.



Hint

- If you want to use another Drive Mode than the 3-second self-timer mode, first set [Self-portrait/ -timer] to [Off], then tilt the monitor upward approx. 180 degrees.

Interchangeable Lens Digital Camera
ILCE-6100 α6100

Movie: Exposure Mode

You can set the exposure mode for movie shooting.

- 1 Set the mode dial to  (Movie).
- 2 MENU →  (Camera Settings2) → [ Exposure Mode] → desired setting.
- 3 Press the MOVIE (movie) button to start recording.
 - Press the MOVIE button again to stop recording.

Menu item details

Program Auto:

Allows you to shoot with the exposure adjusted automatically (both the shutter speed and the aperture value).

Aperture Priority:

Allows you to shoot after adjusting the aperture value manually.

Shutter Priority:

Allows you to shoot after adjusting the shutter speed manually.

Manual Exposure:

Allows you to shoot after adjusting the exposure (both the shutter speed and the aperture value) manually.

Interchangeable Lens Digital Camera
ILCE-6100 α6100

S&Q Motion: Exposure Mode

You can select the exposure mode for slow-motion/quick-motion shooting. You can change the setting and playback speed for slow-motion/quick-motion shooting with [**S&Q** S&Q Settings].

- 1 Set the mode dial to **S&Q** (S&Q Motion).
- 2 MENU →  (Camera Settings2) → [**S&Q** Exposure Mode] → desired setting.
- 3 Press the **MOVIE** (movie) button to start recording.
 - Press the **MOVIE** button again to stop recording.

Menu item details

S&Q **P** Program Auto:

Allows you to shoot with the exposure adjusted automatically (both the shutter speed and the aperture value).

S&Q **A** Aperture Priority:

Allows you to shoot after adjusting the aperture value manually.

S&Q **S** Shutter Priority:

Allows you to shoot after adjusting the shutter speed manually.

S&Q **M** Manual Exposure:

Allows you to shoot after adjusting the exposure (both the shutter speed and the aperture value) manually.



Related Topic

- [S&Q Settings](#)

Interchangeable Lens Digital Camera
 ILCE-6100 α6100

File Format (movie)

Selects the movie file format.

- 1 MENU →  2 (Camera Settings2) → [ File Format] → desired setting.

Menu item details

 File Format	Characteristics	
XAVC S 4K	Records movies in 4K resolution (3840×2160).	You can save movies on a computer using the PlayMemories Home software.
XAVC S HD	Records movies in crisper quality than AVCHD with larger amounts of data.	
AVCHD	The AVCHD format has a high degree of compatibility with storage devices other than computers.	You can save movies on a computer or create a disc that supports this format using the PlayMemories Home software.



Note

- When [ File Format] is set to [AVCHD], the file size of movies is limited to approx. 2 GB. If the movie file size reaches approx. 2 GB during recording, a new movie file will be created automatically.

Interchangeable Lens Digital Camera
ILCE-6100 α6100

Record Setting (movie)





Selects the frame rate and bit-rate for movie recording.

1 MENU →  2 (Camera Settings2) → [ Record Setting] → desired setting.

- The higher the bit-rate, the higher the image quality.











Menu item details

When [ File Format] is set to [XAVC S 4K]

 Record Setting	Bit-rate	Description
30p 100M/ 25p 100M 	Approx. 100 Mbps	Records movies in 3840×2160 (30p/25p).
30p 60M/ 25p 60M 	Approx. 60 Mbps	Records movies in 3840×2160 (30p/25p).
24p 100M  *	Approx. 100 Mbps	Records movies in 3840×2160 (24p).
24p 60M  *	Approx. 60 Mbps	Records movies in 3840×2160 (24p).

* Only when [NTSC/PAL Selector] is set to NTSC





When [ File Format] is set to [XAVC S HD]

 Record Setting	Bit-rate	Description
60p 50M  /50p 50M 	Approx. 50 Mbps	Records movies in 1920×1080 (60p/50p).
60p 25M  /50p 25M 	Approx. 25 Mbps	Records movies in 1920×1080 (60p/50p).
30p 50M  /25p 50M 	Approx. 50 Mbps	Records movies in 1920×1080 (30p/25p).
30p 16M  /25p 16M 	Approx. 16 Mbps	Records movies in 1920×1080 (30p/25p).
24p 50M  *	Approx. 50 Mbps	Records movies in 1920×1080 (24p).
120p 100M/100p 100M	Approx. 100 Mbps	Records high-speed movies in 1920×1080 (120p/100p). You can record movies in 120 fps or 100 fps. <ul style="list-style-type: none"> • You can create smoother slow-motion movies by using compatible editing devices.







 Record Setting	Bit-rate	Description
120p 60M/100p 60M	Approx. 60 Mbps	Records high-speed movies in 1920×1080 (120p/100p). You can record movies in 120 fps or 100 fps. <ul style="list-style-type: none"> You can create smoother slow-motion movies by using compatible editing devices.

* Only when [NTSC/PAL Selector] is set to NTSC

When [File Format] is set to [AVCHD]

 Record Setting	Bit-rate	Description
60i 24M(FX)  /50i 24M(FX) 	24 Mbps at maximum	Records movies in 1920×1080 (60i/50i).
60i 17M(FH)  /50i 17M(FH) 	Approx. 17 Mbps on average	Records movies in 1920×1080 (60i/50i).



Note

- Creating an AVCHD recording disc from movies that were recorded with [60i 24M(FX) ]/[50i 24M(FX) ] as the [ Record Setting] takes a long time because the image quality of movies is converted. If you want to store movies without converting them, use a Blu-ray Disc.
- [120p]/[100p] cannot be selected for the following settings.
 - [Intelligent Auto]
 - [Superior Auto]
 - [Scene Selection]
- The angle of view will be narrower under the following conditions:
 - When [ File Format] is set to [XAVC S HD] and [ Record Setting] is set to [120p]/[100p]
 - When [ File Format] is set to [XAVC S 4K] and [ Record Setting] is set to [30p]
 - During slow-motion/quick-motion shooting

Interchangeable Lens Digital Camera
ILCE-6100 α6100

S&Q Settings

You can record a moment that cannot be captured by the naked eye (slow-motion recording), or record a long-term phenomenon into a compressed movie (quick-motion recording). For example, you can record an intense sports scene, the moment when a bird starts to fly, a blooming flower, and a changing view of clouds or a starry sky. Sound will not be recorded.

- 1 Set the mode dial to **S&Q** (S&Q Motion).
- 2 Select **MENU** →  2 (Camera Settings2) → [**S&Q** Exposure Mode] → and select the desired setting of slow-motion/quick-motion (**S&Q** Program Auto, **S&Q** Aperture Priority, **S&Q** Shutter Priority, or **S&Q** Manual Exposure).
- 3 Select **MENU** →  2 (Camera Settings2) → [**S&Q** S&Q Settings] and select the desired settings for [**S&Q** Record Setting] and [**S&Q** Frame Rate].
- 4 Press the **MOVIE** (movie) button to start recording.
 - Press the **MOVIE** button again to stop recording.

Menu item details

S&Q Record Setting:

Selects the frame rate of the movie.

S&Q Frame Rate:

Selects the shooting frame rate.

Playback speed

The playback speed will vary as below depending on the assigned [**S&Q** Record Setting] and [**S&Q** Frame Rate].

When [**NTSC/PAL Selector**] is set to NTSC

S&Q Frame Rate	S&Q Record Setting		
	24p	30p	60p
120fps	5 times slower	4 times slower	-
60fps	2.5 times slower	2 times slower	Normal playback speed
30fps	1.25 times slower	Normal playback speed	2 times quick
15fps	1.6 times quick	2 times quick	4 times quick
8fps	3 times quick	3.75 times quick	7.5 times quick
4fps	6 times quick	7.5 times quick	15 times quick
2fps	12 times quick	15 times quick	30 times quick
1fps	24 times quick	30 times quick	60 times quick

When [NTSC/PAL Selector] is set to PAL

S&Q Frame Rate	S&Q Record Setting	
	25p	50p
100fps	4 times slower	-
50fps	2 times slower	Normal playback speed
25fps	Normal playback speed	2 times quick
12fps	2.08 times quick	4.16 times quick
6fps	4.16 times quick	8.3 times quick
3fps	8.3 times quick	16.6 times quick
2fps	12.5 times quick	25 times quick
1fps	25 times quick	50 times quick

- When [S&Q Frame Rate] is set to [120fps]/[100fps], you cannot set [S&Q Record Setting] to [60p]/[50p].

Note

- In slow-motion recording, the shutter speed becomes faster and you may not be able to obtain the proper exposure. If this happens, decrease the aperture value or adjust the ISO sensitivity to a higher value.
- For an estimation of recordable time, refer to “Recordable movie times.”
- The bit-rate of a recorded movie varies depending on the settings for [S&Q Frame Rate] and [S&Q Record Setting].
- The movie will be recorded in XAVC S HD format.
- During slow-motion/quick-motion recording, the following functions are not available.
 - [4K Output Select]



Related Topic

- [S&Q Motion: Exposure Mode](#)
- [Recordable movie times](#)

Interchangeable Lens Digital Camera
ILCE-6100 α6100

Proxy Recording

Sets whether to simultaneously record low-bit-rate proxy movies when recording XAVC S movies. Since proxy movies are small in file size, they are suitable for transferring to smartphones or uploading to websites.

1 MENU →  2 (Camera Settings2) → [ Proxy Recording] → desired setting.

Menu item details

On :

Proxy movies are simultaneously recorded.



Off :

Proxy movies are not recorded.

Hint

- Proxy movies are recorded in the XAVC S HD format (1280×720) at 9 Mbps. The frame rate of the proxy movie is the same as that of the original movie.
- Proxy movies are not displayed on the playback screen (single-image playback screen or image index screen).  is displayed over movies for which a proxy movie was simultaneously recorded.

Note

- Proxy movies cannot be played back on this camera.
- Proxy recording is not available in the following situations.
 - When [ File Format] is set to [AVCHD]
 - When [ File Format] is set to [XAVC S HD] and [ Record Setting] is set to [120p]/[100p]
- Deleting/protecting movies that have proxy movies removes/protects both the original and proxy movies. You cannot delete/protect only original movies or proxy movies.
- Movies cannot be edited on this camera.



Related Topic

- [Send to Smartphone Func.: Sending Target \(proxy movies\)](#)
- [Movie recording formats](#)
- [Playing back images on the image index screen \(Image Index\)](#)
- [Memory cards that can be used](#)

Interchangeable Lens Digital Camera
ILCE-6100 α6100

AF drive speed (movie)

You can switch focusing speed when using autofocus in movie mode.

① MENU →  2 (Camera Settings2) → [ AF drive speed] → desired setting.

Menu item details

Fast:

Sets the AF drive speed to fast. This mode is suitable for shooting active scenes, such as sports.

Normal:

Sets the AF drive speed to normal.



Slow:

Sets the AF drive speed to slow. With this mode, the focus switches smoothly when the subject to be focused is changed.

Interchangeable Lens Digital Camera
ILCE-6100 α6100

AF Tracking Sens. (movie)

You can set the AF sensitivity in movie mode.

① MENU →  2 (Camera Settings2) → [ AF Tracking Sens.] → desired setting.

Menu item details

Responsive:



Sets the AF sensitivity to high. This mode is useful when recording movies in which the subject is moving quickly.

Standard:

Sets the AF sensitivity to normal. This mode is useful when there are obstacles in front of the subject or in crowded places.

Auto Slow Shutter (movie)

Sets whether or not to adjust the shutter speed automatically when recording movies if the subject is dark.



1 MENU →  2 (Camera Settings2) → [ Auto Slow Shutter] → **desired setting.**

Menu item details

On:
Uses Auto Slow Shutter. The shutter speed automatically slows when recording in dark locations. You can reduce noise in the movie by using a slow shutter speed when recording in dark locations.

Off:
Does not use Auto Slow Shutter. The recorded movie will be darker than when [On] is selected, but you can record movies with smoother motion and less object blur.



Note

- [ Auto Slow Shutter] does not function in the following situations:
 - During slow-motion/quick-motion shooting
 -  s (Shutter Priority)
 -  M (Manual Exposure)
 - When [ISO] is set to other than [ISO AUTO]

Interchangeable Lens Digital Camera
ILCE-6100 α6100

Initial Focus Mag. (movie)

Sets the initial magnification scale for [Focus Magnifier] in the movie shooting mode.

1 MENU →  2 (Camera Settings2) → [ Initial Focus Mag.] → **desired setting.**

Menu item details

x1.0:

Displays the image with the same magnification as the shooting screen.

x4.0:

Displays a 4.0-times enlarged image.

Related Topic

- [Focus Magnifier](#)

Interchangeable Lens Digital Camera
ILCE-6100 α6100

Audio Recording

Sets whether to record sounds when shooting movies. Select [Off] to avoid recording the sounds of the lens and the camera operating.

1 MENU →  **2** (Camera Settings2) → [Audio Recording] → **desired setting.**

Menu item details

On:

Records sound (stereo).

Off:

Does not record sound.

Audio Rec Level

You can adjust the audio recording level while checking the level meter.

- 1 MENU →  2 (Camera Settings2) → [Audio Rec Level].
- 2 Select the desired level using the right/left sides of the control wheel.

Menu item details

+:

Turns up the audio recording level.

-:

Turns down the audio recording level.

Reset:

Resets the audio recording level to the default setting.

Hint

- When you record audio movies with loud volumes, set [Audio Rec Level] to a lower sound level. Doing so enables you to record more realistic audio. When you record audio movies with lower volumes, set [Audio Rec Level] to a greater sound level to make the sound easier to hear.

Note

- Regardless of the [Audio Rec Level] settings, the limiter always operates.
- [Audio Rec Level] is available only when the shooting mode is set to movie mode.
- [Audio Rec Level] is unavailable during slow-motion/quick-motion shooting.
- The [Audio Rec Level] settings are applied for both the internal microphone and the  (microphone) terminal input.

Interchangeable Lens Digital Camera
ILCE-6100 α6100

Audio Level Display

Sets whether to display the audio level on the screen.

1 MENU →  2 (Camera Settings2) → [Audio Level Display] → desired setting.

Menu item details

On:

Displays the audio level.

Off:

Does not display the audio level.

Note

- The audio level is not displayed in the following situations:
 - When [Audio Recording] is set to [Off].
 - When DISP (Display Setting) is set to [No Disp. Info.].
 - During slow-motion/quick-motion shooting
- The audio level is also displayed while shooting stand-by in movie recording mode.

Interchangeable Lens Digital Camera
ILCE-6100 α6100

Wind Noise Reduct.

Sets whether or not to reduce wind noise by cutting the low-range sound of the input audio from the built-in microphone.

① MENU →  2 (Camera Settings2) → [Wind Noise Reduct.] → desired setting.

Menu item details

On:

Reduces wind noise.

Off:

Does not reduce wind noise.



Note

- Setting this item to [On] where wind is not blowing sufficiently hard may cause normal sound to be recorded with too low volume.
- When an external microphone (sold separately) is used, [Wind Noise Reduct.] does not function.

Interchangeable Lens Digital Camera
ILCE-6100 α6100

Marker Display (movie)

Sets whether or not to display markers set using [ Marker Settings] on the monitor or the viewfinder while shooting movies.

① MENU →  (Camera Settings2) → [ Marker Display] → **desired setting.**

Menu item details

On:

Markers are displayed. The markers are not recorded.

Off:

No marker is displayed.

Note

- The markers are displayed when the mode dial is set to  (Movie) or **S&Q**, or when shooting movies.
- You cannot display markers when using [Focus Magnifier].
- The markers are displayed on the monitor or viewfinder. (You cannot output the markers.)



Related Topic

- [Marker Settings \(movie\)](#)

Interchangeable Lens Digital Camera
ILCE-6100 α6100

Marker Settings (movie)

Sets the markers to be displayed while shooting movies.

1 MENU →  2 (Camera Settings2) → [ Marker Settings] → desired setting.

Menu item details

Center:

Sets whether or not to display the center marker in the center of the shooting screen.

[Off]/[On]

Aspect:

Sets the aspect marker display.

[Off]/[4:3]/[13:9]/[14:9]/[15:9]/[1.66:1]/[1.85:1]/[2.35:1]

Safety Zone:

Sets the safety zone display. This becomes the standard range that can be received by a general household TV.

[Off]/[80%]/[90%]

Guideframe:

Sets whether or not to display the guide frame. You can verify whether the subject is level or perpendicular to the ground.

[Off]/[On]

Hint

- You can display several markers at the same time.
- Place the subject on the cross point of the [Guideframe] to make a balanced composition.

Interchangeable Lens Digital Camera
ILCE-6100 α6100

Movie w/ shutter

You can start or stop recording movies by pressing the shutter button, which is bigger and easier to press than the MOVIE (Movie) button.

1 MENU →  2 (Camera Settings2) → [Movie w/ shutter] → desired setting.

Menu item details

On:

Enables movie recording using the shutter button when the shooting mode is set to [Movie] or [S&Q Motion].

Off:

Disables movie recording using the shutter button.

Hint

- When [Movie w/ shutter] is set to [On], you can still start or stop recording movies using the MOVIE button.

Note

- When [Movie w/ shutter] is set to [On], you cannot focus by pressing the shutter button halfway down during movie recording.



Related Topic

- [Shooting movies](#)

Interchangeable Lens Digital Camera
ILCE-6100 α6100

Silent Shooting (still image)

You can shoot images without the shutter sound.

1 MENU →  2 (Camera Settings2) → [ Silent Shooting] → desired setting.

Menu item details









On:

You can shoot images without the shutter sound.

Off:

[ Silent Shooting] is deactivated.

Note

- Use the [ Silent Shooting] function on your own responsibility, while taking sufficient consideration to the privacy and portrait rights of the subject.
- Even if [ Silent Shooting] is set to [On], it will not be completely silent.
- Even if [ Silent Shooting] is set to [On], the operating sound of the aperture and focus will sound.
- When shooting still images using the [ Silent Shooting] function with low ISO sensitivity, if you point the camera at a very bright light source, high intensity areas on the monitor may be recorded in darker tones.
- When the power is turned off, the shutter sound may beep in rare occasions. This is not a malfunction.
- Image distortion caused by the movement of the subject or the camera may occur.
- If you shoot images under instantaneous lightning or flickering lights, such as the flash light from other cameras or fluorescent lighting, a striping effect may occur on the image.
- If you want to turn off the beep that sounds when the subject is in focus or the self-timer operates, set [Audio signals] to [Off].
- Even if [ Silent Shooting] is set to [On], you may hear the shutter sound under the following circumstances:
 - When you capture a standard white color for the custom white balance
 - When you register faces using [Face Registration]
- You cannot select [ Silent Shooting] when the mode dial is set to other than P/A/S/M.
- When [ Silent Shooting] is set to [On], the following functions are not available:
 - Flash shooting
 - Auto HDR
 - Picture Effect
 -  Long Exposure NR
 - e-Front Curtain Shutter
 - Superior Auto Img. Extract.
 - BULB shooting
 - Multi Frame NR
- After you turn the camera on, the time in which you can start recording is extended by approximately 0.5 seconds.

Interchangeable Lens Digital Camera
ILCE-6100 α6100

e-Front Curtain Shutter

The electronic front curtain shutter function shortens the time lag between when the shutter button is pressed and the shutter is released.

1 MENU →  2 (Camera Settings2) → [e-Front Curtain Shutter] → desired setting.

Menu item details

On:

Uses the electronic front curtain shutter function.

Off:

Does not use the electronic front curtain shutter function.

Note

- When you shoot at high shutter speeds with a large-aperture lens attached, out-of-focus circle produced by the bokeh effect may get cut off because of the shutter mechanism. If this happens, set [e-Front Curtain Shutter] to [Off].
- When a lens made by another manufacturer (including a Minolta/Konica-Minolta lens) is used, set this function to [Off]. If you set this function to [On], the correct exposure will not be set or the image brightness will be uneven.
- When you shoot at high shutter speeds, the image brightness may become uneven depending on the shooting environment. In such cases, set [e-Front Curtain Shutter] to [Off].

Interchangeable Lens Digital Camera
ILCE-6100 α6100

Release w/o Lens

Sets whether or not the shutter can be released when no lens is attached.

1 MENU →  2 (Camera Settings2) → [Release w/o Lens] → desired setting.

Menu item details

Enable:

Releases the shutter when no lens is attached. Select [Enable] when attaching the product to an astronomical telescope, etc.

Disable:

Does not release the shutter when a lens is not attached.

Note

- Correct metering cannot be achieved when you use lenses that do not provide a lens contact, such as the lens of an astronomical telescope. In such cases, adjust the exposure manually by checking it on the recorded image.

Interchangeable Lens Digital Camera
ILCE-6100 α6100

Release w/o Card

Sets whether the shutter can be released when no memory card has been inserted.

1 MENU →  2 (Camera Settings2) → [Release w/o Card] → desired setting.

Menu item details

Enable:

Releases the shutter even if no memory card has been inserted.

Disable:

Does not release the shutter when no memory card has been inserted.

Note

- When no memory card has been inserted, the images shot will not be saved.
- The default setting is [Enable]. It is recommended that you select [Disable] prior to actual shooting.

Interchangeable Lens Digital Camera
ILCE-6100 α6100

SteadyShot

Sets whether or not to use the SteadyShot function.

1 MENU →  2 (Camera Settings2) → [SteadyShot] → desired setting.

Menu item details

On:

Uses [SteadyShot].

Off:

Does not use [SteadyShot].

We recommend that you set [Off] when using a tripod, etc.



Note

- You cannot set the SteadyShot function when you are using an A-mount lens (sold separately), or when the name of the attached lens does not contain the letters "OSS," such as "E16mm F2.8."



Interchangeable Lens Digital Camera
ILCE-6100 α6100

Clear Image Zoom/Digital Zoom (Zoom)

When you use a zoom function other than the optical zoom, you can exceed the zoom range of the optical zoom.

- 1 MENU →  (Camera Settings2) → [Zoom Setting] → [On:ClearImage Zoom] or [On:Digital Zoom].
- 2 **When a power zoom lens is mounted, move the zoom lever or the zoom ring of the zoom lens to enlarge subjects.**
 - When you exceed the zoom range of the optical zoom, the camera automatically switches to another zoom than the optical zoom.
- 3 **When a lens other than a power zoom lens is mounted, select MENU →  (Camera Settings2) → [Zoom] → desired value.**

Press the center of the control wheel to exit.

 - You can also assign the [Zoom] function to the desired button by selecting MENU →  (Camera Settings2) → [ Custom Key] or [ Custom Key].

Related Topic

- [Zoom Setting](#)
- [The zoom features available with this product](#)
- [Assigning frequently used functions to buttons \(Custom Key\)](#)

Interchangeable Lens Digital Camera
ILCE-6100 α6100

Zoom Setting

You can select the zoom setting of the product.

1 MENU →  2 (Camera Settings2) → [Zoom Setting] → desired setting.

Menu item details

Optical zoom only:

Limits the zoom range to the optical zoom. You can use the Smart Zoom function if you set [ JPEG Image Size] to [M] or [S].

On:ClearImage Zoom :

Select this setting to use Clear Image Zoom. Even if the zoom range exceeds the optical zoom, the product magnifies images using an image process with less deterioration.

On:Digital Zoom :

When the zoom range of the Clear Image Zoom is exceeded, the product magnifies images to the largest scale. However, the image quality will deteriorate.

Note

- Set [Optical zoom only] if you want to magnify images within the range in which image quality does not deteriorate.

Related Topic

- [The zoom features available with this product](#)
- [About zoom scale](#)

Interchangeable Lens Digital Camera
ILCE-6100 α6100

DISP Button (Monitor/Finder)

Allows you to set the screen display modes that can be selected using DISP (Display Setting) in shooting mode.

1 MENU →  2 (Camera Settings2) → [DISP Button] → [Monitor] or [Finder] → desired setting → [Enter].

The items marked with ✓ are available.

Menu item details

Graphic Display :

Shows basic shooting information. Graphically shows the shutter speed and aperture value.

Display All Info. :

Shows recording information.

No Disp. Info. :

Does not show recording information.

Histogram :

Displays the luminance distribution graphically.

For viewfinder*:

Displays only shooting information on the monitor, not the subject. This setting is a display setting for shooting with the viewfinder.

Monitor Off*:

Always turns the monitor off when shooting images. You can use the monitor when playing back images or operating MENU. This setting is a display setting for shooting with the viewfinder.

* These screen modes are available only in the setting for [Monitor].

Related Topic

- [Switching the screen display \(while shooting/during playback\)](#)

FINDER/MONITOR

Sets the method for switching the display between the viewfinder and the monitor.

1 MENU →  (Camera Settings2) → [FINDER/MONITOR] → desired setting.

Menu item details

Auto:

When you look into the viewfinder, the eye sensor reacts and the display is switched to the viewfinder automatically.





Viewfinder(Manual):

The monitor is turned off and the image is displayed only in the viewfinder.

Monitor(Manual):

The viewfinder is turned off and the image is always displayed on the monitor.

Hint

- You can assign the [FINDER/MONITOR] function to your preferred key.
MENU →  (Camera Settings2) → [ Custom Key], [ Custom Key] or [ Custom Key] → set [Finder/Monitor Sel.] to the preferred key.
- If you want to retain the viewfinder display or the monitor display, set [FINDER/MONITOR] to [Viewfinder(Manual)] or [Monitor(Manual)] beforehand.
You can keep the monitor off when you take your eyes off the viewfinder during recording by setting the monitor display to [Monitor Off] using the DISP button. Select MENU →  (Camera Settings2) → [DISP Button] → [Monitor] and add a check mark to [Monitor Off] beforehand.

Related Topic

- [Assigning frequently used functions to buttons \(Custom Key\)](#)
- [DISP Button \(Monitor/Finder\)](#)

Interchangeable Lens Digital Camera
ILCE-6100 α6100

Zebra Setting

Sets a zebra pattern, which appears over part of an image if the brightness level of that part meets the IRE level that you have set. Use this zebra pattern as a guide to adjust the brightness.

1 MENU →  2 (Camera Settings2) → [Zebra Setting] → desired setting.

Menu item details

Zebra Display:

Sets whether to display the zebra pattern.

Zebra Level:

Adjusts the brightness level of the zebra pattern.

Hint

- You can register values to check the correct exposure or overexposure as well as the brightness level for [Zebra Level]. The settings for correct exposure confirmation and overexposure confirmation are registered to [Custom1] and [Custom2] respectively in the default settings.
- To check the correct exposure, set a standard value and the range for the brightness level. The zebra pattern will appear on areas that fall within the range you set.
- To check the overexposure, set a minimum value for the brightness level. The zebra pattern will appear over areas with a brightness level equal to or higher than the value you set.

Note

- The zebra pattern is not displayed on devices connected via HDMI.

Interchangeable Lens Digital Camera
ILCE-6100 α6100

Grid Line

Sets whether the grid line is displayed or not. The grid line will help you to adjust the composition of images.

1 MENU →  2 (Camera Settings2) → [Grid Line] → desired setting.

Menu item details

Rule of 3rds Grid:

Place main subjects close to one of the grid lines that divide the image into thirds for a well-balanced composition.

Square Grid:

Square grids make it easier to confirm the horizontal level of your composition. This is useful for assessing the composition when shooting landscapes, closeups, or when performing camera scanning.

Diag. + Square Grid:

Place a subject on the diagonal line to express an uplifting and powerful feeling.

Off:

Does not display the grid line.

Interchangeable Lens Digital Camera
ILCE-6100 α6100

Exposure Set. Guide

You can set whether to display a guide when you change the exposure.

① MENU →  2 (Camera Settings2) → [Exposure Set. Guide] → desired setting.

Menu item details

Off:

Does not display the guide.

On:

Displays the guide.

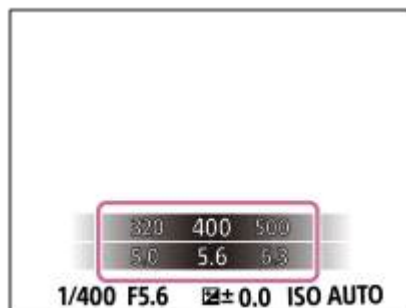

Interchangeable Lens Digital Camera
ILCE-6100 α6100

Live View Display

Sets whether or not to show images altered with effects of the exposure compensation, white balance, [Creative Style], or [Picture Effect] on the screen.

1 MENU →  2 (Camera Settings2) → [Live View Display] → desired setting.

Menu item details

Setting Effect ON:

Displays Live View in conditions close to what your picture will look like as a result of applying all your settings. This setting is useful when you want to shoot pictures while checking the results of the shot on the Live View screen.

Setting Effect OFF:

Displays Live View without the effects of exposure compensation, white balance, [Creative Style], or [Picture Effect]. When this setting is used, you can easily check the image composition.

Live View is always displayed with the appropriate brightness even in [Manual Exposure] mode.

When [Setting Effect OFF] is selected, the **VIEW** icon is displayed on the Live View screen.

Hint

- When you use a third-party flash, such as a studio flash, Live View Display may be dark for some shutter speed settings. When [Live View Display] is set to [Setting Effect OFF], Live View Display will be displayed brightly, so that you can easily check the composition.

Note

- [Live View Display] cannot be set to [Setting Effect OFF] in the following shooting modes:
 - [Intelligent Auto]
 - [Superior Auto]
 - [Sweep Panorama]
 - [Movie]
 - [S&Q Motion]
 - [Scene Selection]
- When [Live View Display] is set to [Setting Effect OFF], the brightness of the shot image will not be the same as that of the displayed Live View.

Interchangeable Lens Digital Camera
ILCE-6100 α6100

Auto Review

You can check the recorded image on the screen right after the shooting. You can also set the display time for Auto Review.

1 MENU →  2 (Camera Settings2) → [Auto Review] → desired setting.

Menu item details

10 Sec/5 Sec/2 Sec:

Displays the recorded image on the screen right after shooting for the selected duration of time. If you perform a magnifying operation during Auto Review, you can check that image using the magnified scale.

Off:

Does not display the Auto Review.

Note

- When you use a function that performs image processing, the image before processing may be displayed temporarily, followed by the image after processing.
- The DISP (Display Setting) settings are applied for the Auto Review display.



Related Topic

- [Enlarging an image being played back \(Enlarge Image\)](#)

Interchangeable Lens Digital Camera
ILCE-6100 α6100

Assigning frequently used functions to buttons (Custom Key)

You can use the custom key function to assign the functions you use most frequently to easily operable keys. This lets you skip the process of selecting items from MENU, so you can recall the functions more quickly. You can also assign [Not set] to easily operable keys to prevent accidental operation.

You can separately assign functions to custom keys for the still image shooting mode ( Custom Key), movie shooting mode ( Custom Key), and playback mode ( Custom Key).

- Assignable functions vary depending on the keys.

You can assign functions to the following keys.

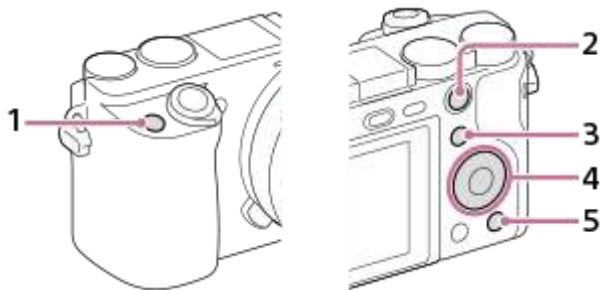





1. Custom Button 1
2. AEL Button
3. Fn/  Button
4. Center Button /Left Button/Right Button/Down Button
5. Custom Button 2

For details on functions that can be assigned to custom keys, refer to the following URL:
<https://support.d-imaging.sony.co.jp/support/tutorial/ilc//ilce-6100/custom.php>







Hint

- You can recall functions more quickly by using the Function menu to configure each setting directly from the Fn button, along with the custom keys. Refer to the related functions under “Related Topic” at the bottom of this page.

The following is the procedure for assigning the [Eye AF] function to the AEL button.

- 1 MENU →  2 (Camera Settings2) → [ Custom Key].**
 - If you want to assign a function to recall while shooting movies, select [ Custom Key]. If you want to assign a function to recall while playing back images, select [ Custom Key].
- 2 Move to the [Rear1] screen using the left/right side of the control wheel. Then, select [AEL Button] and press the center of the control wheel.**
- 3 Press the left/right side of the control wheel until [Eye AF] is displayed. Select [Eye AF], and then press the center.**
 - If you press the AEL button in the still image shooting mode and eyes are detected, [Eye AF] will activate, and the camera will focus on the eyes. Shoot images while holding down the AEL button.

Note

- You can also assign shooting functions to the focus hold button on the lens. However, some lenses do not have a focus hold button.
- If you assign [Follow Custom ()] to a custom key using [ Custom Key], but the function is one that is unavailable in the movie shooting mode such as [ JPEG Quality] or [Flash Mode], the function will not be recalled when you press the key in the movie shooting mode.
- If you assign [Follow Custom ( / )] to a custom key using [ Custom Key], the camera will switch to the shooting mode and recall the assigned function when you press the key in the playback mode.

Related Topic

- [Using Fn \(Function\) button \(Function menu\)](#)

Interchangeable Lens Digital Camera
 ILCE-6100 α6100

Using Fn (Function) button (Function menu)

The Function menu is a menu of 12 functions that is displayed at the bottom of the screen when you press the Fn (Function) button in the shooting mode. You can access frequently used functions more quickly by registering them to the function menu.



For details on functions that can be registered to the function menu, refer to the following URL:
<https://support.d-imaging.sony.co.jp/support/tutorial/ilc//ilce-6100/function.php>

Hint

- You can recall functions more quickly by using the custom key function to assign frequently used functions to desired keys, along with the function menu. Refer to the related functions under “Related Topic” at the bottom of this page.

- 1 Press the DISP on the control wheel repeatedly to display a screen mode other than [For viewfinder], and then press the Fn (Function) button.



- 2 Select the desired function by pressing the top/bottom/left/right side of the control wheel.

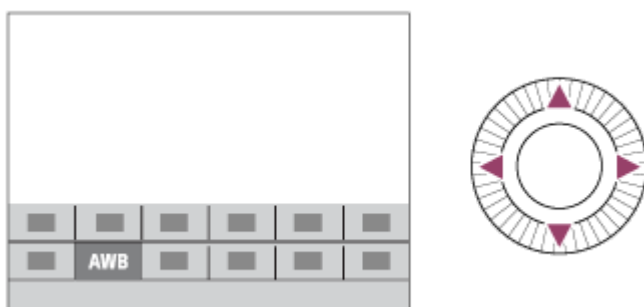

3 Select the desired setting by turning the control wheel, and press the center of the control wheel.

- Some functions can be fine-tuned using the control dial.

To adjust settings from the dedicated setting screens

Select the desired function in step 2, then press the center of the control wheel. The dedicated setting screen for the function will appear. Follow the operating guide **(A)** to adjust settings.

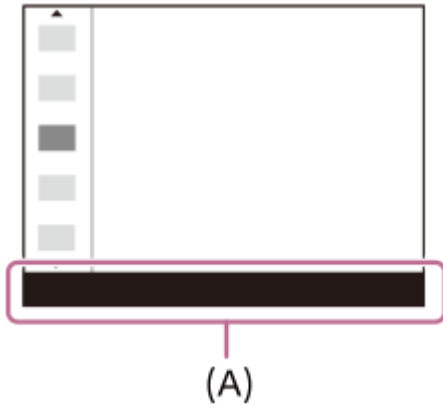

To change the functions in the function menu (Function Menu Set.)

The following is the procedure for changing [Drive Mode] in the function menu to [Grid Line].

1. MENU → 2 (Camera Settings2) → [Function Menu Set.].
2. Select (Drive Mode) from among the twelve functions in the function menu using the top/bottom/left/right side of the control wheel, and then press the center.
3. Move to the [Display/Auto Review] screen using the left/right side of the control wheel. Then, select [Grid Line] and press the center of the control wheel.
 - (Grid Line) will be displayed in the former location of (Drive Mode) in the function menu.

Related Topic

- [Assigning frequently used functions to buttons \(Custom Key\)](#)

Interchangeable Lens Digital Camera
ILCE-6100 α6100

Dial/Wheel Setup



You can switch the functions of the control dial and the control wheel.

1 MENU →  2 (Camera Settings2) → [Dial/Wheel Setup] → desired setting.

Menu item details

 SS  F/no.:

You can change the shutter speed using the control wheel, and change the aperture value using the control dial.

 F/no.  SS:

You can change the aperture value using the control wheel, and change the shutter speed using the control dial.

Note

- [Dial/Wheel Setup] is enabled when the shooting mode is set to "M."

Interchangeable Lens Digital Camera
ILCE-6100 α6100

Dial/Wheel Ev Comp

You can adjust the exposure compensation using the control dial or the control wheel.

1 MENU →  2 (Camera Settings2) → [Dial/Wheel Ev Comp] → desired setting.

Menu item details

Off:

Does not assign the exposure compensation function to the control dial or control wheel.

Wheel:

Assigns the exposure compensation function to the control wheel.

Dial:

Assigns the exposure compensation function to the control dial.

Note

- If you assign the exposure compensation function to the control dial, the function that was originally assigned can be managed using the control wheel, and vice versa.
- When the shooting mode is set to [Manual Exposure] and ISO is set to [ISO AUTO], [Dial/Wheel Ev Comp] is disabled.

Interchangeable Lens Digital Camera
ILCE-6100 α6100

Func. of Touch Operation: Touch Shutter

When you shoot using the monitor, the camera automatically focuses on the point you touch and shoots a still image. Set MENU →  (Setup) → [Touch Operation] to [On] in advance.

1 Select MENU →  (Camera Settings2) → [Func. of Touch Operation] → [Touch Shutter].

2 Touch the  icon inside the rectangle in the top right of the monitor while the shooting screen is displayed.

The mark to the left of the icon turns orange, and the touch shutter function is activated.

- To cancel [Touch Shutter], touch the  icon again.
- The touch shutter function is canceled when the camera is restarted.

3 Touch the subject to focus on.

When the subject you touched is in focus, a still image is recorded.

Hint

- You can operate the shooting functions below by touching the monitor:
 - Shooting burst images using the touch shutter
When [Drive Mode] is set to [Cont. Shooting], you can record burst images while touching the monitor.
 - Shooting burst images of sports scenes using the touch shutter
When [Scene Selection] is set to [Sports Action], you can record burst images while touching the monitor.
 - Shooting continuous bracket images using the touch shutter
The product shoots three images while automatically shifting the exposure from base, to darker, and then to lighter. When [Drive Mode] is set to [Cont. Bracket], keep touching the monitor until the shooting ends. After the recording you can select the image you prefer.

Note

- The [Touch Shutter] function is unavailable in the following situations:
 - During viewfinder shooting
 - When the shooting mode is set to [Movie]
 - When the shooting mode is set to [S&Q Motion]
 - When the shooting mode is set to [Sweep Panorama]
 - During [Smile Shutter] mode
 - When [Focus Mode] is [Manual Focus]
 - When [Focus Area] is [Flexible Spot]
 - When [Focus Area] is [Expand Flexible Spot]
 - When [Focus Area] is [Tracking: Flexible Spot]
 - When [Focus Area] is [Tracking: Expand Flexible Spot]
 - While using the digital zoom function
 - While using the  Clear Image Zoom]

Related Topic

- [Touch Operation](#)

5-009-879-12(1) Copyright 2019 Sony Corporation

Interchangeable Lens Digital Camera
ILCE-6100 α6100

Func. of Touch Operation: Touch Focus

[Touch Focus] allows you to specify a position where you want to focus using touch operations. This function is available when [Focus Area] is set to a parameter other than [Flexible Spot], [Expand Flexible Spot], [Tracking: Flexible Spot] or [Tracking: Expand Flexible Spot]. Select MENU →  (Setup) → [Touch Operation] → [On] beforehand.

1 MENU →  2 (Camera Settings2) → [Func. of Touch Operation] → [Touch Focus].

Specifying the position where you want to focus in the still image mode

You can specify a position where you want to focus using touch operations. After touching the monitor and specifying a position, press the shutter button halfway down to focus.

1. Touch the monitor.

- When shooting with the monitor, touch the position where you want to focus.
- When shooting with the viewfinder, you can move the position of the focus by touching and dragging on the monitor while looking through the viewfinder.

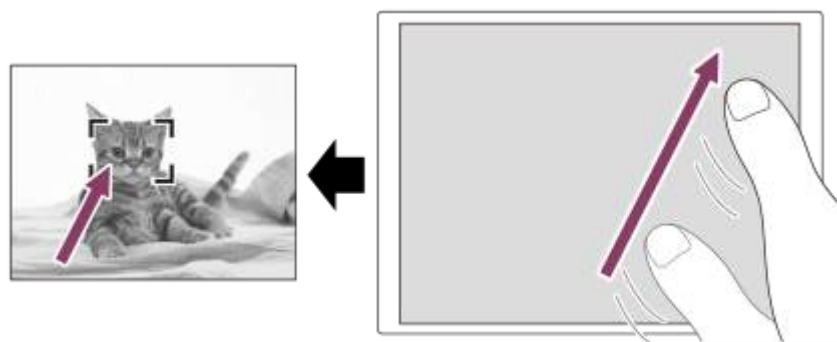

- To cancel focusing with touch operations, touch  or press the center of the control wheel if shooting with the monitor, and press the center of the control wheel if shooting with the viewfinder.

2. Press the shutter button halfway down to focus.

- Press the shutter button all the way down to shoot images.

Specifying the position where you want to focus in the movie recording mode (spot focus)

The camera will focus on the touched subject. Spot focus is not available when shooting with the viewfinder.

1. Touch the subject on which you want to focus before or during recording.

- When you touch the subject, the focus mode temporarily switches to manual focus and the focus can be adjusted using the focus ring.
- To cancel spot focus, touch  or press the center of the control wheel.

Hint

- In addition to the touch focus function, touch operations such as the following are also available.
 - When [Focus Area] is set to [Flexible Spot], [Expand Flexible Spot], [Tracking: Flexible Spot] or [Tracking: Expand Flexible Spot], the focusing frame can be moved using touch operations.
 - When the [Focus Mode] is set to [Manual Focus], the focus magnifier can be used by double-tapping the monitor.

Note

- The touch focus function is not available in the following situations:
 - When the shooting mode is set to [Sweep Panorama].
 - When [Focus Mode] is set to [Manual Focus].
 - When using the digital zoom
 - When using the LA-EA2 or LA-EA4

Related Topic

- [Touch Operation](#)
- [Touch Panel/Pad](#)

Func. of Touch Operation: Touch Tracking

You can use touch operations to select a subject you want to track in the still image and movie recording modes.
Select MENU →  (Setup) → [Touch Operation] → [On] in advance.

- 1 MENU →  (Camera Settings2) → [Func. of Touch Operation] → [Touch Tracking].
- 2 Touch the subject that you want to track on the monitor.
Tracking will start.
- 3 Press the shutter button halfway down to focus.
 - Press the shutter button all the way down to shoot images.

Hint

- To cancel tracking, touch  or press the center of the control wheel.

Note

- [Touch Tracking] is unavailable in the following situations:
 - When [Scene Selection] is [Hand-held Twilight] or [Anti Motion Blur].
 - When shooting movies with [ Record Setting] set to [120p]/[100p].
 - When shooting mode is set to [Sweep Panorama].
 - When [Focus Mode] is set to [Manual Focus].
 - When using the Smart Zoom, Clear Image Zoom and Digital Zoom
 - When using the LA-EA2 or LA-EA4 Mount Adaptor
 - When [Subject Detection] under [Face/Eye AF Set.] is set to [Animal]

Related Topic

- [Touch Operation](#)

Interchangeable Lens Digital Camera
ILCE-6100 α6100

MOVIE Button

Sets whether or not to activate the MOVIE (Movie) button.

① MENU →  (Camera Settings2) → [MOVIE Button] → desired setting.

Menu item details

Always:

Starts movie recording when you press the MOVIE button in any mode.

Movie Mode Only:

Starts movie recording when you press the MOVIE button only if the shooting mode is set to [Movie] or [S&Q Motion] mode.

Interchangeable Lens Digital Camera
ILCE-6100 α6100

Dial / Wheel Lock

You can set whether the dial and wheel will be locked by pressing and holding the Fn (Function) button.

1 MENU →  2 (Camera Settings2) → [Dial / Wheel Lock] → desired setting.

Menu item details

Lock:

Locks the control dial and control wheel.

Unlock:

Does not lock the control dial or control wheel even if you press and hold the Fn (Function) button.

Hint

- You can release the lock by holding the Fn (Function) button down again.

Interchangeable Lens Digital Camera
ILCE-6100 α6100

Audio signals

Selects whether the product produces a sound or not.

1 MENU →  2 (Camera Settings2) → [Audio signals] → desired setting.

Menu item details

On:

Sounds are produced for example when the focus is achieved by pressing the shutter button halfway down.

Off:

Sounds are not produced.

Note

- If [Focus Mode] is set to [Continuous AF], the camera will not beep when it focuses on a subject.

Interchangeable Lens Digital Camera
ILCE-6100 α6100

Send to Smartphone Func.: Send to Smartphone

You can transfer still images, XAVC S movies, slow-motion movies, or quick-motion movies to a smartphone and view them. The application Imaging Edge Mobile must be installed on your smartphone.

1 MENU → (Network) → [Send to Smartphone Func.] → [Send to Smartphone] → desired setting.

- If you press the  (Send to Smartphone) button in playback mode, the setting screen for [Send to Smartphone] will appear.

2 If the product is ready for the transfer, the information screen appears on the product. Connect the smartphone and the product using that information.

- The setting method for connecting the smartphone and the product varies depending on the smartphone.



Menu item details

Select on This Device:

Selects an image on the product to be transferred to the smartphone.

(1) Select from among [This Image], [All with this date] or [Multiple Images].

- The options displayed may differ depending on the View Mode selected on the camera.

(2) If you select [Multiple Images], select the desired images using the center of the control wheel, then press MENU → [Enter].

Select on Smartphone:

Displays all images recorded on the product's memory card on the smartphone.

Note

- You can only transfer images that are saved on the camera's memory card.
- You can select an image size to be sent to the smartphone from [Original], [2M] or [VGA].
To change the image size, refer to the following steps.
 - For Android smartphone
Start Imaging Edge Mobile, and change the image size by [Settings] → [Copy Image Size].
 - For iPhone/iPad
Select Imaging Edge Mobile in the setting menu, and change the image size by [Copy Image Size].
- RAW images are converted to JPEG format when they are sent.
- You cannot send AVCHD format movies.

- Depending on the smartphone, the transferred movie may not be played back correctly. For example, the movie may not play smoothly, or there may be no sound.
- Depending on the format of the still image, movie, slow-motion movie, or quick-motion movie, it may not be possible to play it back on a smartphone.
- This product shares the connection information for [Send to Smartphone] with a device that has permission to connect. If you want to change the device that is permitted to connect to the product, reset the connection information by following these steps. MENU →  (Network) → [Wi-Fi Settings] → [SSID/PW Reset]. After resetting the connection information, you must register the smartphone again.
- When [Airplane Mode] is set to [On], you cannot connect this product and the smartphone. Set [Airplane Mode] to [Off].
- While you transfer many images or long movies, we recommend that you supply power to the camera from a wall outlet (wall socket) using the AC Adaptor (supplied).

Related Topic

- [Imaging Edge Mobile](#)
- [Controlling the camera using a smartphone \(NFC One-touch remote\)](#)
- [Controlling the camera using an Android smartphone \(QR Code\)](#)
- [Controlling the camera using an Android smartphone \(SSID\)](#)
- [Controlling the camera using an iPhone or iPad \(QR Code\)](#)
- [Controlling the camera using an iPhone or iPad \(SSID\)](#)
- [Sending images to a smartphone \(NFC One-touch Sharing\)](#)
- [Send to Smartphone Func.: Sending Target \(proxy movies\)](#)
- [Airplane Mode](#)

Interchangeable Lens Digital Camera
ILCE-6100 α6100

Send to Smartphone Func.: Sending Target (proxy movies)

When transferring XAVC S video to a smartphone with [Send to Smartphone], you can set whether to transfer the low-bit-rate proxy movie or the high-bit-rate original movie.

1 MENU →  (Network) → [Send to Smartphone Func.] → [**Px** Sending Target] → desired setting.

Menu item details

Proxy Only:

Transfers only proxy movies.

Original Only:

Transfers only original movies.

Proxy & Original:

Transfers both proxy and original movies.

Note

- While you transfer many images or long movies, we recommend that you supply power to the camera from a wall outlet (wall socket) using the AC Adaptor (supplied).

Related Topic

- [Send to Smartphone Func.: Send to Smartphone](#)
- [Proxy Recording](#)

Interchangeable Lens Digital Camera
ILCE-6100 α6100

Send to Computer

You can transfer images stored in the product to a computer connected to a wireless access point or wireless broadband router and easily make backup copies using this operation. Before starting this operation, install PlayMemories Home on your computer and register the access point on the product.

1 Start your computer.

2 MENU →  **(Network)** → **[Send to Computer]**.

Note

- Depending on the application settings of your computer, the product will turn off after saving the images to your computer.
- You can transfer images from the product to only one computer at a time.
- If you want to transfer images to another computer, connect the product and the computer via a USB connection and follow the instructions in PlayMemories Home.
- Proxy movies cannot be transferred.

Related Topic

- [Installing PlayMemories Home](#)
- [Wi-Fi Settings: WPS Push](#)
- [Wi-Fi Settings: Access Point Set.](#)

Interchangeable Lens Digital Camera
ILCE-6100 α6100

View on TV

You can view images on a network-enabled TV by transferring them from the product without connecting the product and TV with a cable. For some TVs, you may need to perform operations on the TV. For details, refer to the operating instructions supplied with the TV.

1 MENU →  (Network) → [View on TV] → desired device to be connected.

2 When you want to play back images using slideshow, press the center of the control wheel.

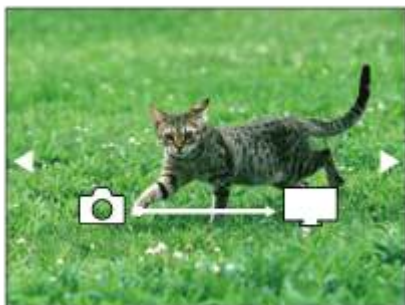

- To display the next/previous image manually, press the right/left sides of the control wheel.
- To change the device to be connected, press the down side of the control wheel, then select [Device list].

Slideshow settings

You can change the slideshow settings by pressing the down side of the control wheel.

Playback Selection:

Selects the group of images to be shown.

Folder View(Still):

Selects from [All] and [All in Folder].

Date View:

Selects from [All] and [All in Date Rng.].

Interval:

Selects from [Short] and [Long].

Effects*:

Selects from [On] and [Off].

Playback Image Size:

Selects from [HD] and [4K].

* The settings are effective only for BRAVIA TV which is compatible with the functions.

Note

- You can use this function on a TV that supports DLNA renderer.
- You can view images on a Wi-Fi Direct-enabled TV or network-enabled TV (including wired network-enabled TVs).
- If you connect TV and this product and do not use Wi-Fi Direct, you need to register your access point first.
- Displaying the images on the TV may take time.
- Movies cannot be shown on a TV via Wi-Fi. Use an HDMI cable (sold separately).
- When [Display as Group] is set to [On], only the first image of the group is transferred to the TV.

Related Topic

- [Wi-Fi Settings: WPS Push](#)
- [Wi-Fi Settings: Access Point Set.](#)

5-009-879-12(1) Copyright 2019 Sony Corporation

Interchangeable Lens Digital Camera
ILCE-6100 α6100

Ctrl w/ Smartphone

Sets the condition for connecting the camera to a smartphone.

1 MENU →  (Network) → [Ctrl w/ Smartphone] → desired setting.

Menu item details

Ctrl w/ Smartphone:

Sets whether to connect the camera and a smartphone using Wi-Fi. ([On]/[Off])

Connection:

Displays the QR code or SSID used to connect the camera to a smartphone.

Always Connected:

Sets whether to keep the camera connected to a smartphone. If this item is set to [On], once you connect the camera to a smartphone, it will remain connected to the smartphone at all times. If it is set to [Off], the camera will connect to a smartphone only when the connection procedure is performed.

Note

- If [Always Connected] is set to [On], the power consumption will be greater than when it is set to [Off].

Related Topic

- [Controlling the camera using a smartphone \(NFC One-touch remote\)](#)
- [Controlling the camera using an Android smartphone \(QR Code\)](#)
- [Controlling the camera using an Android smartphone \(SSID\)](#)
- [Controlling the camera using an iPhone or iPad \(QR Code\)](#)
- [Controlling the camera using an iPhone or iPad \(SSID\)](#)
- [Send to Smartphone Func.: Send to Smartphone](#)

Interchangeable Lens Digital Camera
ILCE-6100 α6100

Airplane Mode

When you board an airplane, etc., you can temporarily disable all the wireless-related functions including Wi-Fi.

1 MENU →  (Network) → [Airplane Mode] → **desired setting.**

If you set [Airplane Mode] to [On], an airplane mark will be displayed on the screen.

Interchangeable Lens Digital Camera
ILCE-6100 α6100

Wi-Fi Settings: WPS Push

If your access point has a Wi-Fi Protected Setup (WPS) button, you can register the access point to this product easily.

- 1 MENU →  (Network) → [Wi-Fi Settings] → [WPS Push].
- 2 Push the Wi-Fi Protected Setup (WPS) button on the access point to connect.

Note

- [WPS Push] works only if the security setting of your access point is set to WPA or WPA2 and your access point supports the Wi-Fi Protected Setup (WPS) button method. If the security setting is set to WEP or your access point does not support the Wi-Fi Protected Setup (WPS) button method, perform [Access Point Set.].
- For details about the available functions and settings of your access point, see the access point operating instructions or contact the administrator of the access point.
- A connection may not be possible or the communication distance may be shorter depending on the surrounding conditions, such as the type of wall material and the presence of obstructions or radio waves between the product and access point. In this case, change the location of the product or move the product closer to the access point.

Related Topic

- [Wi-Fi Settings: Access Point Set.](#)

Wi-Fi Settings: Access Point Set.

You can register your access point manually. Before starting the procedure, check the SSID name of the access point, security system, and password. The password may be preset in some devices. For details, see the access point operating instructions, or consult the access point administrator.

1 MENU →  (Network) → [Wi-Fi Settings] → [Access Point Set.].

2 Select the access point you want to register.

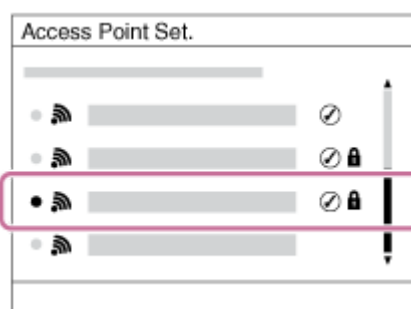

When the desired access point is displayed on the screen: Select the desired access point.

When the desired access point is not displayed on the screen: Select [Manual Setting] and set the access point.

- If you select [Manual Setting], input the SSID name of the access point, then select the security system.

3 Input the password, and select [OK].

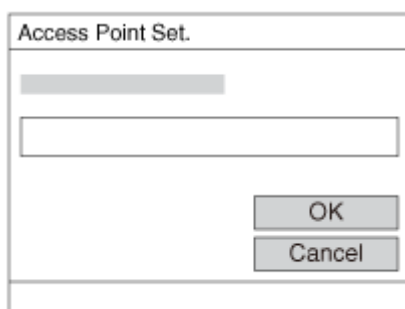

- Access points without the  mark do not require a password.

4 Select [OK].

Other setting items

Depending on the status or the setting method of your access point, you may want to set more items.

WPS PIN:

Displays the PIN code you enter into the connected device.

Priority Connection:

Select [On] or [Off].

IP Address Setting:

Select [Auto] or [Manual].

IP Address:

If you are entering the IP address manually, enter the set address.

Subnet Mask/Default Gateway:

If you have set [IP Address Setting] to [Manual], enter each address according to your network environment.

Note

- To give the registered access point priority in the future, set [Priority Connection] to [On].

Related Topic

- [Wi-Fi Settings: WPS Push](#)
- [How to use the keyboard](#)

Interchangeable Lens Digital Camera
ILCE-6100 α6100

Wi-Fi Settings: Disp MAC Address

Displays the Wi-Fi MAC address of this product.

1 MENU →  (Network) → [Wi-Fi Settings] → [Disp MAC Address].

Interchangeable Lens Digital Camera
ILCE-6100 α6100

Wi-Fi Settings: SSID/PW Reset

This product shares connection information for [Send to Smartphone] and [Connection] under [Ctrl w/ Smartphone] with devices that have permission to connect. If you want to change the devices that are permitted to connect, reset the connection information.

1 MENU →  (Network) → [Wi-Fi Settings] → [SSID/PW Reset] → [OK].

Note

- If you connect this product to a smartphone after resetting the connection information, you must make the settings for the smartphone again.

Related Topic

- [Send to Smartphone Func.: Send to Smartphone](#)
- [Ctrl w/ Smartphone](#)

Interchangeable Lens Digital Camera
ILCE-6100 α6100

Bluetooth Settings

Controls the settings for connecting the camera to a smartphone or Bluetooth remote commander via a Bluetooth connection.

If you want to pair the camera and smartphone in order to use the location information link function, refer to “Location Info. Link Set..”

If you want to perform pairing in order to use a Bluetooth remote commander, refer to “Bluetooth Rmt Ctrl.”

1 MENU →  (Network) → [Bluetooth Settings] → desired setting.

Menu item details

Bluetooth Function (On/Off):

Sets whether to activate or not the Bluetooth function of the camera.

Pairing:

Displays the screen for pairing the camera and smartphone or Bluetooth remote commander.

Disp Device Address:

Displays the BD address of the camera.

Related Topic

- [Location Info. Link Set.](#)
- [Bluetooth Rmt Ctrl](#)

Interchangeable Lens Digital Camera
ILCE-6100 α6100

Location Info. Link Set.

You can use the application Imaging Edge Mobile to obtain location information from a smartphone that is connected with your camera using Bluetooth communication. You can record the obtained location information when shooting images.

Preparation in advance









To use the location information linking function of the camera, the application Imaging Edge Mobile is required. If “Location Information Linkage” is not displayed on the top page of Imaging Edge Mobile, you need to perform the following steps beforehand.

1. Install Imaging Edge Mobile on your smartphone.
 - You can install Imaging Edge Mobile from the application store of your smartphone. If you have already installed the application, update it to the latest version.
2. Transfer a pre-recorded image to your smartphone using the [Send to Smartphone] function of the camera.
 - After you transfer an image recorded using the camera to your smartphone, “Location Information Linkage” will appear on the top page of the application.



Operating procedure

: Operations performed on the smartphone

: Operations performed on the camera

1. : Confirm that the Bluetooth function of your smartphone is activated.
 - Do not perform the Bluetooth pairing operation on the smartphone setting screen. In steps 2 to 7, the pairing operation is performed using the camera and the application Imaging Edge Mobile.
 - If you accidentally perform the pairing operation on the smartphone setting screen in step 1, cancel the pairing and then perform the pairing operation by following Steps 2 through 7 using the camera and the application Imaging Edge Mobile.
2. : On the camera, select MENU →  (Network) → [Bluetooth Settings] → [Bluetooth Function] → [On].
3. : On the camera, select MENU →  (Network) → [Bluetooth Settings] → [Pairing].
4. : Launch Imaging Edge Mobile on your smartphone and tap “Location Information Linkage.”
 - If “Location Information Linkage” is not displayed, follow the steps in “Preparation in advance” above.
5. : Activate [Location Information Linkage] on the [Location Information Linkage] setting screen of Imaging Edge Mobile.
6. : Follow the instructions on the [Location Information Linkage] setting screen of Imaging Edge Mobile, and then select your camera from the list.
7. : Select [OK] when a message is displayed on the monitor of the camera.

- Pairing of the camera and Imaging Edge Mobile is complete.

8.  : On the camera, select MENU →  (Network) → [ Location Info. Link Set.] → [Location Info. Link] → [On].

-  (obtaining location information icon) will be displayed on the monitor of the camera. Location information obtained by your smartphone using GPS, etc., will be recorded when shooting images.

Menu item details

Location Info. Link:

Sets whether to obtain the location information by linking with a smartphone.

Auto Time Correct.:

Sets whether to automatically correct the date setting of the camera using information from a linked smartphone.

Auto Area Adjust.:

Sets whether to automatically correct the area setting of the camera using information from a linked smartphone.

Icons displayed when obtaining the location information

 (Obtaining location information): The camera is obtaining the location information.

 (Location information cannot be obtained): The camera cannot obtain the location information.

 (Bluetooth connection available): Bluetooth connection with the smartphone is established.

 (Bluetooth connection unavailable): Bluetooth connection with the smartphone is not established.

Hint

- Location information can be linked when Imaging Edge Mobile is running on your smartphone even if the smartphone monitor is off. However, if the camera has been turned off for a while, location information may not be linked immediately when you turn the camera back on. In this case, location information will be linked immediately if you open the Imaging Edge Mobile screen on the smartphone.
- When Imaging Edge Mobile is not operating, such as when the smartphone is restarted, launch Imaging Edge Mobile to resume location information linking.
- If the location information linking function does not work properly, see the following notes and perform pairing again.
 - Confirm that the Bluetooth function of your smartphone is activated.
 - Confirm that the camera is not connected with other devices using the Bluetooth function.
 - Confirm that [Airplane Mode] for the camera is set to [Off].
 - Delete the pairing information for the camera registered in Imaging Edge Mobile.
 - Execute [Reset Network Set.] of the camera.
- For more detailed instructions, refer to the following support page.
<https://www.sony.net/iem/btg/>

Note

- When you initialize the camera, the pairing information is also deleted. To perform pairing again, delete the pairing information for the camera registered in Imaging Edge Mobile before trying again.
- The location information will not be recorded when it cannot be obtained, such as when the Bluetooth connection is disconnected.
- The camera can be paired with up to 15 Bluetooth devices, but can link the location information with that of only one smartphone. If you want to link the location information with that of another smartphone, turn off the [Location Information Linkage] function of the smartphone that is already linked.
- If the Bluetooth connection is unstable, remove any obstacles, such as people or metal objects from between the camera and the paired smartphone.
- When pairing the camera and your smartphone, be sure to use the [Location Information Linkage] menu on Imaging Edge Mobile.
- To use the location information linkage function, set [Bluetooth Rmt Ctrl] to [Off].
- The communication distance for Bluetooth or Wi-Fi may vary depending on the conditions of use.

Supported smartphones

Refer to the support page for the latest information.

<https://www.sony.net/iem/>

- For details on Bluetooth versions compatible with your smartphone, check the product website for your smartphone.
-

Related Topic



- [Imaging Edge Mobile](#)
- [Send to Smartphone Func.: Send to Smartphone](#)
- [Bluetooth Settings](#)
- [Bluetooth Rmt Ctrl](#)

5-009-879-12(1) Copyright 2019 Sony Corporation

Interchangeable Lens Digital Camera
ILCE-6100 α6100

Bluetooth Rmt Ctrl

You can operate the camera using a Bluetooth remote commander RMT-P1BT (sold separately). Select MENU →  (Network) → [Bluetooth Settings] → [Bluetooth Function] → [On] in advance. Refer to the instruction manual for the Bluetooth remote commander as well.

- 1 On the camera, select MENU →  (Network) → [Bluetooth Rmt Ctrl] → [On].**
 - If there is no Bluetooth device currently paired with the camera, the screen for pairing as described in Step 2 will appear.
- 2 On the camera, select MENU →  (Network) → [Bluetooth Settings] → [Pairing] to display the screen for pairing.**
- 3 On the Bluetooth remote commander, perform pairing.**
 - For details, refer to the instruction manual for the Bluetooth remote commander.
- 4 On the camera, select [OK] on the confirmation screen for the Bluetooth connection.**
 - Pairing is complete, and you can now operate the camera from the Bluetooth remote commander. After pairing the device once, you can connect the camera and the Bluetooth remote commander again in the future by setting [Bluetooth Rmt Ctrl] to [On].

Menu item details

On:

Enables Bluetooth remote commander operation.

Off:

Disables Bluetooth remote commander operation.

Hint

- The Bluetooth connection is only active while you are operating the camera using the Bluetooth remote commander.
- If the function does not work properly, check the following notes and then try pairing again.
 - Confirm that the camera is not connected with other devices using the Bluetooth function.
 - Confirm that [Airplane Mode] for the camera is set to [Off].
 - Execute [Reset Network Set.] of the camera.

Note

- When you initialize the camera, the pairing information is also deleted. To use the Bluetooth remote commander, perform pairing again.
- If the Bluetooth connection is unstable, remove any obstacles, such as people or metal objects from between the camera and the paired Bluetooth remote commander.
- You cannot use the function for linking location information with a smartphone while [Bluetooth Rmt Ctrl] is set to [On].
- While [Bluetooth Rmt Ctrl] is set to [On], the camera will not switch to the power-saving mode. Change the setting to [Off] when you are done using the Bluetooth remote commander.

Related Topic

- [Bluetooth Settings](#)

5-009-879-12(1) Copyright 2019 Sony Corporation

Interchangeable Lens Digital Camera
ILCE-6100 α6100

Edit Device Name

You can change the device name for the Wi-Fi Direct or Bluetooth connection.

- 1 **MENU** →  **(Network)** → **[Edit Device Name]**.
 - 2 **Select the input box, then input the device name** → **[OK]**.
-

Related Topic

- [Wi-Fi Settings: WPS Push](#)
- [Wi-Fi Settings: Access Point Set.](#)
- [How to use the keyboard](#)

Interchangeable Lens Digital Camera
ILCE-6100 α6100

Reset Network Set.

Resets all the network settings to default settings.

① **MENU** →  **(Network)** → **[Reset Network Set.]** → **[Enter]**.

Interchangeable Lens Digital Camera
ILCE-6100 α6100

Protecting images (Protect)



Protects recorded images against accidental erasure. The  mark is displayed on protected images.

① MENU →  (Playback) → [Protect] → desired setting.

Menu item details

Multiple Img.:

Applies the protection of the selected multiple images.

(1) Select the image to be protected, then press the center of the control wheel. The  mark is displayed in the check box. To cancel the selection, press the center again to remove the  mark.

(2) To protect other images, repeat step (1).

(3) MENU → [OK].

All in this Folder:

Protects all images in the selected folder.

All with this date:

Protects all images taken on the selected date.

Cancel All in this Folder:

Cancels the protection of all images in the selected folder.

Cancel All with this date:

Cancels the protection of all images taken on the selected date.

All Images in This Group:

Protects all the images in the selected group.

Cancel All in This Group:

Cancels the protection of all the images in the selected group.

Hint

- If you assign [Protect] to the key of your choice using MENU →  2 (Camera Settings2) → [ Custom Key], you can protect images or cancel protection by simply pressing the key.
- If you select a group in [Multiple Img.], all the images in the group will be protected. To select and protect particular images within the group, execute [Multiple Img.] while displaying the images within the group.

Note

- The menu items that can be selected vary according to the [View Mode] setting and the selected content.

Interchangeable Lens Digital Camera
ILCE-6100 α6100

Rotating an image (Rotate)

Rotates a recorded image counter-clockwise.

1 Display the image to be rotated, then select **MENU** →  (Playback) → **[Rotate]**.

2 Press the center of the control wheel.

The image is rotated counter-clockwise. The image rotates as you press the center.

If you rotate the image once, the image remains rotated even after the product is turned off.

Note

- You cannot rotate the movies.
- You may not be able to rotate images shot using other products.
- When viewing rotated images on a computer, the images may be displayed in their original orientation depending on the software.

Deleting multiple selected images (Delete)



You can delete multiple selected images. Once you have deleted an image, you cannot restore it. Confirm the image to be deleted beforehand.

- 1 MENU →  (Playback) → [Delete] → desired setting.

Menu item details

Multiple Img.:

Deletes the selected images.

(1) Select the images to be deleted, then press the center of the control wheel. The  mark is displayed in the check box. To cancel the selection, press the center again to remove the  mark.

(2) To delete other images, repeat step (1).

(3) MENU → [OK].

All in this Folder:

Deletes all images in the selected folder.

All with this date:

Deletes all images taken on the selected date.

All Other Than This Img.:

Deletes all images in the group except the selection.

All Images in This Group:

Deletes all images in the selected group.

Hint

- Perform [Format] to delete all images, including protected images.
- To display the desired folder or date, select the desired folder or date during playback by performing the following procedure:
 (Image Index) button → select the bar on the left using the control wheel → select the desired folder or date using the top/bottom sides of the control wheel.
- If you select a group in [Multiple Img.], all the images in the group will be deleted. To select and delete particular images within the group, execute [Multiple Img.] while displaying the images within the group.

Note

- The protected images cannot be deleted.
- The menu items that can be selected vary according to the [View Mode] setting and the selected content.

Related Topic

- [Deleting a displayed image](#)
- [Format](#)

Rating

You can assign ratings to recorded images on a scale from ★ to ★★ to make it easier to find images. Combining this function with [Image Jump Setting] allows you to find a desired image quickly.

- 1 MENU →  (Playback) → [Rating].**
The image rating selection screen will appear.
- 2 Press the left/right sides of the control wheel to display an image to which you want to assign a rating, and then press the center.**
- 3 Select the number of ★ (Rating) by pressing the left/right sides of the control wheel, and then press the center.**
- 4 Press the MENU button to exit the rating setting screen.**

Hint

- You can also assign ratings when playing back images by using the custom key. Assign [Rating] to the desired key using [ Custom Key] beforehand, and then press the custom key while playing back an image to which you want to assign a rating. The number of ★ (Rating) changes each time you press the custom key.

Note

- You can assign ratings to still images only.

Related Topic

- [Assigning frequently used functions to buttons \(Custom Key\)](#)
- [Rating Set\(Custom Key\)](#)
- [Setting the method for jumping between images \(Image Jump Setting\)](#)

Interchangeable Lens Digital Camera
ILCE-6100 α6100

Rating Set(Custom Key)

Sets the available number of ★ when rating images with the key to which you have assigned [Rating] using [ Custom Key].

1 MENU →  (Playback) → [Rating Set(Custom Key)].

2 Add a  mark to the number of ★ that you want to activate.

You can select the checked number when setting [Rating] using the custom key.

Related Topic

- [Rating](#)
- [Assigning frequently used functions to buttons \(Custom Key\)](#)

Interchangeable Lens Digital Camera
ILCE-6100 α6100

Specifying images to be printed (Specify Printing)

You can specify in advance on the memory card which still images you want to print out later. The **DPOF** (print order) icon will appear on the specified images. DPOF refers to “Digital Print Order Format.”



DPOF setting will be retained after the image is printed. We recommend that you cancel this setting after printing.

1 MENU →  (Playback) → [Specify Printing] → desired setting.

Menu item details

Multiple Img.:

Selects images to order printing.

(1) Select an image and press the center of the control wheel. The  mark is displayed in the check box. To cancel the selection, press the center again and delete the  mark.

(2) Repeat step (1) to print other images. To select all the images from a certain date or in a certain folder, select the check box for the date or folder.

(3) MENU → [OK].

Cancel All:

Clears all DPOF marks.

Print Setting:

Sets whether to print the date on images registered with DPOF marks.



- The position or size of the date (inside or outside of the image) may differ depending on the printer.

Note

- You cannot add the DPOF mark to the following files:
 - RAW images
- The number of copies cannot be specified.
- Some printers do not support the date print function.

Photo Capture

Captures a chosen scene in a movie to save as a still image. First shoot a movie, then pause the movie during playback to capture decisive moments that tend to be missed when shooting still images, and save them as still images.

- 1 **Display the movie that you want to capture as a still image.**
- 2 **MENU** →  (Playback) → [Photo Capture].
- 3 **Play back the movie and pause it.**
- 4 **Find the desired scene using forward slow playback, reverse slow playback, displays the next frame, and displays the previous frame, and then stop the movie.**
- 5 **Press  (Photo Capture) to capture the chosen scene.**
The scene is saved as a still image.

Related Topic



- [Shooting movies](#)
- [Playing back movies](#)

Enlarging an image being played back (Enlarge Image)

Enlarges the image being played back. Use this function to check the focus of the image, etc.

- 1 Display the image you want to enlarge, and then press the  button.**
 - Turn the control wheel to adjust the zoom scale. By rotating the control dial, you can switch to the previous or next image while keeping the same zoom scale.
 - The view will zoom in on the part of the image where the camera focused during shooting. If the focus location information cannot be obtained, the camera will zoom in on the center of the image.
- 2 Select the portion you want to enlarge by pressing the top/bottom/right/left sides of the control wheel.**
- 3 Press the MENU button or the center of the control wheel to exit the playback zoom.**

Hint

- You can also enlarge an image being played back using MENU.
- You can change the initial magnification and initial position of enlarged images by selecting MENU →  (Playback) → [ Enlarge Initial Mag.] or [ Enlarge Initial Position].
- You can also enlarge an image by double-tapping the monitor. In addition, you can drag and move the magnified position on the monitor. Set [Touch Operation] to [On] beforehand.

Note

- You cannot enlarge movies.

Related Topic

- [Touch Operation](#)
- [Enlarge Initial Mag.](#)
- [Enlarge Initial Position](#)

Interchangeable Lens Digital Camera
ILCE-6100 α6100

Enlarge Initial Mag.

Sets the initial magnification scale when playing back enlarged images.

1 MENU →  (Playback) → [ Enlarge Initial Mag.] → desired setting.

Menu item details

Standard. Mag.:

Displays an image with the standard magnification.

Previous Mag.:

Displays an image with the previous magnification. The previous magnification is stored even after exiting the playback zoom mode.

Related Topic

- [Enlarging an image being played back \(Enlarge Image\)](#)
- [Enlarge Initial Position](#)

Interchangeable Lens Digital Camera
ILCE-6100 α6100

Enlarge Initial Position

Sets the initial position when enlarging an image in playback.

1 MENU →  (Playback) → [ Enlarge Initial Position] → desired setting.

Menu item details

Focused Position:

Enlarges the image from the point of focus during shooting.

Center:

Enlarges the image from the center of the screen.

Related Topic



- [Enlarging an image being played back \(Enlarge Image\)](#)
- [Enlarge Initial Mag.](#)

Interchangeable Lens Digital Camera
ILCE-6100 α6100

Cont. PB for Interval



Continuously plays back images shot using interval shooting.

You can create movies from still images produced by interval shooting using the computer software Imaging Edge (Viewer). You cannot create movies from the still images on the camera.

1 MENU →  (Playback) → [Cont. PB for  Interval].

2 Select the image group that you want to play back, and then press the center of the control wheel.

Hint

- On the playback screen, you can start continuous playback by pressing the down button while displaying an image in the group.
- You can resume play or pause by pressing the down button during playback.
- You can change the playback speed by turning the control dial or the control wheel during playback. You can also change the playback speed by selecting MENU →  (Playback) → [PB Speed for  Interval].
- You can continuously play back images shot with continuous shooting as well.

Related Topic

- [Interval Shoot Func.](#)
- [PB Speed for Interval](#)
- [Imaging Edge](#)

Interchangeable Lens Digital Camera
ILCE-6100 α6100

PB Speed for Interval

Sets the playback speed for still images during [Cont. PB for  Interval].

1 MENU →  (Playback) → [PB Speed for  Interval] → desired setting.

Hint

- You can also change the playback speed by turning the control dial or the control wheel during [Cont. PB for  Interval].

Related Topic

- [Cont. PB for Interval](#)

Playing back images using slideshow (Slide Show)

Automatically plays back images continuously.

1 MENU →  (Playback) → [Slide Show] → desired setting.

2 Select [Enter].

Menu item details

Repeat:

Select [On], in which images are played back in a continuous loop, or [Off], in which the product exits the slideshow when all the images are played back once.

Interval:

Select the display interval for images from among [1 Sec], [3 Sec], [5 Sec], [10 Sec] or [30 Sec].

To quit the slideshow in the middle of playback

Press the MENU button to quit the slideshow. You cannot pause the slideshow.

Hint

- During playback, you can display the next/previous image by pressing the right/left side of the control wheel.
- You can activate a slideshow only when [View Mode] is set to [Date View] or [Folder View(Still)].

Interchangeable Lens Digital Camera
ILCE-6100 α6100

Switching between still images and movies (View Mode)

Sets the View Mode (image display method).

1 MENU →  (Playback) → [View Mode] → desired setting.

Menu item details

Date View:

Displays the images by date.

Folder View(Still):

Displays only still images.

AVCHD View:

Displays only AVCHD-format movies.

XAVC S HD View:

Displays only XAVC S HD-format movies.

XAVC S 4K View:

Displays only XAVC S 4K-format movies.

Playing back images on the image index screen (Image Index)

You can display multiple images at the same time in playback mode.

- 1 Press the  (Image Index) button while the image is being played back.
- 2 Select the image by pressing the top/bottom/right/left sides of the control wheel or turning the control wheel.

To change the number of images to be displayed

MENU →  (Playback) → [Image Index] → desired setting.

Menu item details

12 Images/30 Images

To return to single-image playback

Select the desired image and press the center of the control wheel.

To display a desired image quickly

Select the bar on the left of the image index screen using the control wheel, then press the top/bottom sides of the control wheel. While the bar is being selected, you can display the calendar screen or folder selection screen by pressing the center. In addition, you can switch View Mode by selecting an icon.

Related Topic

- [Switching between still images and movies \(View Mode\)](#)

Display as Group

Sets whether or not to display continuously shot images or images shot using interval shooting as a group.

1 MENU →  (Playback) → [Display as Group] → desired setting.

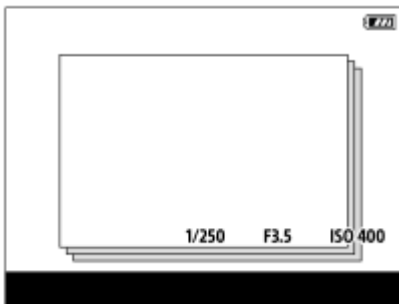

Menu item details



On:

Displays images as a group.

Off:

Does not display images as a group.

Hint

- The following images are grouped.
 - Images shot with [Drive Mode] set to [Cont. Shooting] (One sequence of images shot continuously by holding down the shutter button during continuous shooting becomes one group.)
 - Images shot with [ Interval Shoot Func.] (Images shot during one session of interval shooting become one group.)
- On the image index screen,  is displayed over the group.

Note

- Images can be grouped and displayed only when [View Mode] is set to [Date View]. When it is not set to [Date View], images cannot be grouped and displayed, even if [Display as Group] is set to [On].
- If you delete the group, all the images in the group will be deleted.

Related Topic

- [Cont. Shooting](#)
- [Interval Shoot Func.](#)

Interchangeable Lens Digital Camera
ILCE-6100 α6100

Rotating recorded images automatically (Display Rotation)

Selects the orientation when playing back recorded images.

1 MENU →  (Playback) → [Display Rotation] → desired setting.

Menu item details

Manual:

Images shot vertically are displayed vertically. If you have set the image orientation using the [Rotate] function, the image will be displayed accordingly.

Off:

Images are always displayed horizontally.

Related Topic

- [Rotating an image \(Rotate\)](#)

Setting the method for jumping between images (Image Jump Setting)

Sets which dial and method to use for jumping between images during playback. You can quickly find protected images or images set with a particular rating.

1 MENU →  (Playback) → [Image Jump Setting] → desired item.

Menu item details

Select Dial/Wheel:

Selects the dial or wheel to use for jumping between images.

Image Jump Method:

Sets the method for playing back with Image Jump.

Note

- [Image Jump Setting] is available only when [View Mode] is set to [Date View]. If [View Mode] is not set to [Date View], the camera will always play back every image without jumping when you use the dial selected with [Select Dial/Wheel].
- When you use the Image Jump function, movie files are always skipped.

Related Topic

- [Rating](#)
- [Protecting images \(Protect\)](#)

Interchangeable Lens Digital Camera
ILCE-6100 α6100

Monitor Brightness

Adjust the brightness of the screen.

1 MENU →  (Setup) → [Monitor Brightness] → desired setting.

Menu item details

Manual:

Adjusts the brightness within the range of -2 to +2.

Sunny Weather:

Sets the brightness appropriately for shooting outdoors.

Note

- The [Sunny Weather] setting is too bright for shooting indoors. Set [Monitor Brightness] to [Manual] for indoor shooting.

Interchangeable Lens Digital Camera
ILCE-6100 α6100

Viewfinder Bright.

When using the viewfinder, this product adjusts the brightness of the viewfinder according to the surrounding environment.

① **MENU** →  (Setup) → [Viewfinder Bright.] → **desired setting.**

Menu item details

Auto:

Adjusts the brightness automatically.

Manual:

Selects the brightness of the viewfinder within the range of -2 to +2.

Interchangeable Lens Digital Camera
ILCE-6100 α6100

Finder Color Temp.

Adjusts the color temperature of the electronic viewfinder.

1 MENU →  (Setup) → [Finder Color Temp.] → desired setting.

Menu item details

-2 to +2:

When you select “-,” the viewfinder screen changes to a warmer color, and when you select “+,” it changes to a colder color.

Interchangeable Lens Digital Camera
ILCE-6100 α6100

Volume Settings

Sets the sound volume for movie playback.

1 MENU →  (Setup) → [Volume Settings] → desired setting.

Adjusting the volume during playback

Press the bottom side of the control wheel while playing back movies to display the operation panel, then adjust the volume. You can adjust the volume while listening to the actual sound.

Interchangeable Lens Digital Camera
ILCE-6100 α6100

Tile Menu

Selects whether to always display the first screen of the menu when you press the MENU button.

① MENU →  (Setup) → [Tile Menu] → desired setting.

Menu item details

On:

Always displays the first screen of the menu (Tile Menu).

Off:

Deactivates the Tile Menu display.

Interchangeable Lens Digital Camera
ILCE-6100 α6100

Mode Dial Guide

You can display the description of a shooting mode when you turn the mode dial and change the settings available for that shooting mode.

1 MENU →  (Setup) → [Mode Dial Guide] → desired setting.

Menu item details

On:

Displays the Mode Dial Guide.

Off:

Does not display the Mode Dial Guide.

Interchangeable Lens Digital Camera
ILCE-6100 α6100

Delete confirm.

You can set whether [Delete] or [Cancel] is selected as a default on the delete confirmation screen.

① MENU →  (Setup) → [Delete confirm.] → desired setting.

Menu item details

"Delete" first:

[Delete] is selected as the default setting.

"Cancel" first:

[Cancel] is selected as the default setting.

Interchangeable Lens Digital Camera
ILCE-6100 α6100

Display Quality

You can change the display quality.

1 MENU →  (Setup) → [Display Quality] → desired setting.

Menu item details

High:

Displays in high quality.

Standard:

Displays in standard quality.

Note

- When [High] is set, battery consumption will be higher than when [Standard] is set.
- When the temperature of the camera rises, the setting may become locked to [Standard].

Interchangeable Lens Digital Camera
ILCE-6100 α6100

Power Save Start Time

Sets time intervals to automatically switch to power save mode when you are not performing operations to prevent wearing down the battery pack. To return to shooting mode, perform an operation such as pressing the shutter button halfway down.

1 MENU →  (Setup) → [Power Save Start Time] → desired setting.

Menu item details

30 Min/5 Min/2 Min/1 Min/10 Sec

Note

- Turn off the product when you do not use it for a long time.
- The power save function is deactivated in the following situations:
 - While power is being supplied via USB
 - While playing back slideshows
 - While recording movies
 - While connected to a computer or TV
 - When [Bluetooth Rmt Ctrl] is set to [On]

Interchangeable Lens Digital Camera
ILCE-6100 α6100

Auto Power OFF Temp.

Sets the temperature of the camera at which the camera turns off automatically during shooting. When it is set to [High], you can continue shooting even when the temperature of the camera gets hotter than normal.

1 MENU →  (Setup) → [Auto Power OFF Temp.] → desired setting.

Menu item details

Standard:

Sets the standard temperature for the camera to turn off.

High:

Sets the temperature at which the camera turns off to higher than [Standard].

Notes when [Auto Power OFF Temp.] is set to [High]

- Do not shoot while holding the camera in your hand. Use a tripod.
- Using the camera while holding it in your hand for a long period of time may cause low-temperature burns.

Continuous recording time for movies when [Auto Power OFF Temp.] is set to [High]

The duration of time available for continuous movie recording is as follows when the camera starts recording with the default settings after the power has been turned off for a while. The following values indicate the continuous time from when the camera starts recording until the camera stops recording.

Ambient temperature: 20°C (68°F)

Continuous recording time for movies (HD): Approx. 30 minutes

Continuous recording time for movies (4K): Approx. 30 minutes

Ambient temperature: 30°C (86°F)

Continuous recording time for movies (HD): Approx. 30 minutes

Continuous recording time for movies (4K): Approx. 30 minutes

Ambient temperature: 40°C (104°F)

Continuous recording time for movies (HD): Approx. 30 minutes

Continuous recording time for movies (4K): Approx. 30 minutes

HD: XAVC S HD (60p 50M/50p 50M, when the camera is not connected via Wi-Fi)

4K: XAVC S 4K (24p 60M/25p 60M, when the camera is not connected via Wi-Fi)

Note

- Even if [Auto Power OFF Temp.] is set to [High], depending on the conditions or the temperature of the camera, the recordable time for movies may not change.

Related Topic

- [Recordable movie times](#)

Interchangeable Lens Digital Camera
ILCE-6100 α6100

NTSC/PAL Selector

Plays back movies recorded with the product on a NTSC/PAL system TV.

① MENU →  (Setup) → [NTSC/PAL Selector] → [Enter]

Note

- If you insert a memory card that has previously been formatted with a different video system, a message telling you that you must reformat the card will appear.
If you want to record using another system, re-format the memory card or use another memory card.
- When you perform [NTSC/PAL Selector], and the setting is changed from the default one, a message "Running on NTSC." or "Running on PAL." will appear on the start-up screen.

Cleaning Mode

If dust or debris gets inside the camera and adheres to the surface of the image sensor (the part that converts the light to an electric signal), it may appear as dark spots on the image, depending on the shooting environment. If this happens, follow the steps below to clean the image sensor.

- 1 Confirm that the battery has been charged sufficiently.
- 2 MENU →  (Setup) → [Cleaning Mode] → [Enter].
- 3 Turn off the product following the instructions on the screen.
- 4 Detach the lens.
- 5 Use the blower to clean the image sensor surface and the surrounding area.

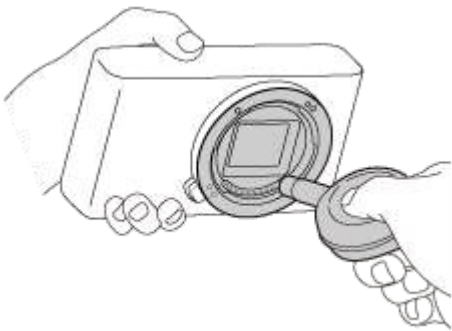

- 6 Attach the lens.

Hint

- For how to check the amount of dust on the image sensor, and for further details on cleaning methods, please refer to the following URL.
<https://support.d-imaging.sony.co.jp/www/support/ilc/sensor/index.php>

Note

- Clean the image sensor quickly.
- A blower is not supplied with this product. Use a commercially available blower.
- Make sure that the remaining battery level is  (3 remaining battery icons) or more, before performing the cleaning. The use of AC adaptor (supplied) is recommended.
- Do not use a spray type blower as it may scatter water droplets inside the camera body.
- Do not put the tip of a blower into the cavity beyond the lens mount area, so that the tip of the blower does not touch the image sensor.
- Hold the camera slightly face downward so that the dust falls out.

- Do not subject the product to any shock during cleaning.
- When cleaning the image sensor with a blower, do not blow too hard. If you blow the sensor too hard, the inside of the product may be damaged.
- If the dust remains even after you cleaned the product as described, consult the service facility.

Related Topic

- [Troubleshooting](#)

5-009-879-12(1) Copyright 2019 Sony Corporation

Interchangeable Lens Digital Camera
ILCE-6100 α6100

Touch Operation

Sets whether or not to activate touch operations on the monitor.

1 MENU →  (Setup) → [Touch Operation] → desired setting.

Menu item details

On:

Activates the touch operation.

Off:

Deactivates the touch operation.

Related Topic

- [Func. of Touch Operation: Touch Shutter](#)
- [Func. of Touch Operation: Touch Focus](#)
- [Func. of Touch Operation: Touch Tracking](#)
- [Touch Pad Settings](#)
- [Touch Panel/Pad](#)

Interchangeable Lens Digital Camera
ILCE-6100 α6100

Touch Panel/Pad

Touch operations when shooting with the monitor are referred to as "touch panel operations," and touch operations when shooting with the viewfinder are referred to as "touch pad operations." You can select whether to activate touch panel operations or touch pad operations.

1 MENU →  (Setup) → [Touch Panel/Pad] → desired setting.

Menu item details

Touch Panel+Pad:

Activates both the touch panel operations when shooting with the monitor and touch pad operations when shooting with the viewfinder.

Touch Panel Only:

Activates only the touch panel operations when shooting with the monitor.

Touch Pad Only:

Activates only the touch pad operations when shooting with the viewfinder.

Related Topic

- [Touch Operation](#)

Touch Pad Settings

You can adjust settings related to touch pad operations during viewfinder shooting.

1 **MENU** →  (Setup) → **[Touch Pad Settings]** → **desired setting**.

Menu item details

Operation in Vertical Orientation :

Sets whether to enable touch pad operations during vertically oriented viewfinder shooting. You can prevent erroneous operations during vertically oriented shooting caused by your nose, etc. touching the monitor.

Touch Position Mode:

Sets whether to move the focusing frame to the position touched on the screen ([Absolute Position]), or move the focusing frame to the desired position based on the direction of dragging and the amount of movement ([Relative Position]).

Operation Area:

Sets the area to be used for touch pad operations. Restricting the operational area can prevent erroneous operations caused by your nose, etc. touching the monitor.

About Touch Positioning Mode

Selecting [Absolute Position] lets you move the focusing frame to a distant position more quickly because you can directly specify the position of the focusing frame with touch operations.

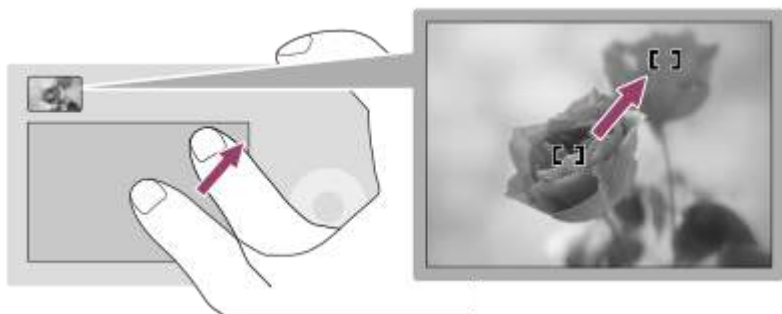

Selecting [Relative Position] lets you operate the touch pad from wherever is easiest, without having to move your finger over a wide area.

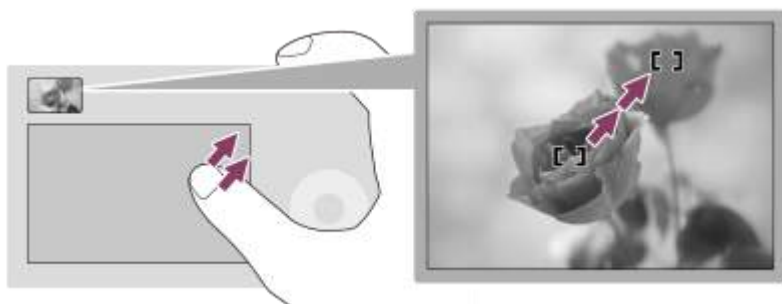

Hint

- In touch pad operations when [Touch Position Mode] is set to [Absolute Position], the area set in [Operation Area] is treated as the entire screen.

Related Topic

- [Touch Operation](#)

5-009-879-12(1) Copyright 2019 Sony Corporation

Interchangeable Lens Digital Camera
ILCE-6100 α6100

Demo Mode

The [Demo Mode] function displays the movies recorded on the memory card automatically (demonstration), when the camera has not been operated for a certain time. Normally select [Off].

① MENU →  (Setup) → [Demo Mode] → desired setting.

Menu item details

On:

The movie playback demonstration starts automatically if the product is not operated for about one minute. Only protected AVCHD movies can be played back.

Set the view mode to [AVCHD View], and protect the movie file with the oldest recorded date and time.

Off:

Does not show the demonstration.

Note

- You can set this item only when the product is powered by the AC Adaptor (supplied).
- When there is no protected AVCHD movies on the memory card, you cannot select [On].

Interchangeable Lens Digital Camera
ILCE-6100 α6100

HDMI Settings: HDMI Resolution

When you connect the product to a High Definition (HD) TV with HDMI terminals using an HDMI cable (sold separately), you can select HDMI Resolution to output images to the TV.

① MENU →  (Setup) → [HDMI Settings] → [HDMI Resolution] → desired setting.

Menu item details

Auto:

The product automatically recognizes an HD TV and sets the output resolution.

2160p/1080p:

Outputs signals in 2160p/1080p.

1080p:

Outputs signals in HD picture quality (1080p).

1080i:





Outputs signals in HD picture quality (1080i).

Note

- If the images are not displayed properly using the [Auto] setting, select either [1080i], [1080p] or [2160p/1080p], based on which TV is to be connected.

Interchangeable Lens Digital Camera
ILCE-6100 α6100

HDMI Settings: 24p/60p Output (movie) (Only for 1080 60i compatible models)

You can set 1080/24p or 1080/60p as the HDMI output format when [ Record Setting] is set to [24p 50M , [24p 60M ] or [24p 100M ].

1 MENU →  (Setup) → [HDMI Settings] → [HDMI Resolution] → [1080p] or [2160p/1080p].

2 MENU →  (Setup) → [HDMI Settings] → [ 24p/60p Output] → desired setting.

Menu item details

60p:

Movies are output as 60p.

24p:

Movies are output as 24p.

Note

- Steps 1 and 2 can be set in either order.

Related Topic

- [Record Setting \(movie\)](#)

Interchangeable Lens Digital Camera
ILCE-6100 α6100

HDMI Settings: HDMI Info. Display

Selects whether to display the shooting information when this product and the TV are connected using an HDMI cable (sold separately).

1 MENU →  (Setup) → [HDMI Settings] → [HDMI Info. Display] → desired setting.

Menu item details

On:

Displays the shooting information on the TV.

The recorded image and the shooting information are displayed on the TV, while nothing is displayed on the camera's monitor.

Off:

Does not display the shooting information on the TV.

Only the recorded image is displayed on the TV, while the recorded image and the shooting information are displayed on the camera's monitor.

Note

- When the camera is connected to an HDMI device while [ File Format] is set to [XAVC S 4K], the setting switches to [Off].

Interchangeable Lens Digital Camera
ILCE-6100 α6100

HDMI Settings: CTRL FOR HDMI

When connecting this product to a “BRAVIA” Sync-compatible TV using an HDMI cable (sold separately), you can operate this product by aiming the TV remote control at the TV.

- 1 **MENU** →  (**Setup**) → **[HDMI Settings]** → **[CTRL FOR HDMI]** → **desired setting**.
- 2 **Connect this product to a “BRAVIA” Sync-compatible TV.**
The input of the TV is switched automatically and images on this product are displayed on the TV screen.
- 3 **Press the SYNC MENU button of the TV’s remote control.**
- 4 **Operate this product using the TV’s remote control.**

Menu item details

On:

You can operate this product with a TV’s remote control.

Off:

You cannot operate this product with a TV’s remote control.



Note

- If you connect this product to a TV using an HDMI cable, available menu items are limited.
- [CTRL FOR HDMI] is available only with a “BRAVIA” Sync-compatible TV. Also, the SYNC MENU operation differs depending on the TV you are using. For details, refer to the operating instructions supplied with the TV.
- If the product performs unwanted operations in response to the TV remote control when the product is connected to another manufacturer’s TV using an HDMI connection, select MENU →  (Setup) → [HDMI Settings] → [CTRL FOR HDMI] → [Off].

Interchangeable Lens Digital Camera
ILCE-6100 α6100

4K Output Select (movie)

You can set how to record movies and perform HDMI output when your camera is connected to 4K-compatible external recording/playback devices, etc.

- 1 Turn the mode dial to  (movie).
- 2 Connect the camera to the desired device via an HDMI cable.
- 3 MENU →  (Setup) → [ 4K Output Select] → desired setting.

Menu item details

Memory Card+HDMI:

Simultaneously outputs to the external recording/playback device and records on the camera's memory card.

HDMI Only(30p):

Outputs a 4K movie in 30p to the external recording/playback device without recording on the camera's memory card.

HDMI Only(24p) ^{Super}_{35mm} :



Outputs a 4K movie in 24p to the external recording/playback device without recording on the camera's memory card.

HDMI Only(25p) ^{Super}_{35mm} * :

Outputs a 4K movie in 25p to the external recording/playback device without recording on the camera's memory card.

* Only when [NTSC/PAL Selector] is set to PAL.

Note

- This item can be set only when the camera is in movie mode and connected to a 4K-compatible device.
- When [HDMI Only(30p)], [HDMI Only(24p) ^{Super}_{35mm}] or [HDMI Only(25p) ^{Super}_{35mm}] is set, [HDMI Info. Display] will temporarily be set to [Off].
- A 4K movie is not output to the connected 4K-compatible device during slow-motion/quick-motion shooting.
- When [HDMI Only(30p)], [HDMI Only(24p) ^{Super}_{35mm}] or [HDMI Only(25p) ^{Super}_{35mm}] is set, the counter does not move forward (the actual recording time is not counted) while the movie is being recorded on an external recording/playback device.
- When shooting 4K movies using the setting [Memory Card+HDMI], the movies will not be output to a device connected by HDMI cable if you simultaneously record a proxy movie. If you want to perform HDMI output, set [ Proxy Recording] to [Off]. (In this case, the image will not be displayed on the screen of the camera).
- When [ File Format] is set to [XAVC S 4K] and the camera is connected via HDMI, the following functions are not available.
 - [Face/Eye Priority in AF]
 - [Face Priority in Multi Metering]
 - Tracking function

Related Topic

- [File Format \(movie\)](#)
- [Record Setting \(movie\)](#)
- [HDMI Settings: HDMI Info. Display](#)

Interchangeable Lens Digital Camera
ILCE-6100 α6100

USB Connection

Selects the USB connection method when this product is connected to a computer, etc.

Select MENU →  (Network) → [Ctrl w/ Smartphone] → [Ctrl w/ Smartphone] → [Off] beforehand.

1 MENU →  (Setup) → [USB Connection] → **desired setting.**

Menu item details

Auto:

Establishes a Mass Storage or MTP connection automatically, depending on the computer or other USB devices to be connected. Windows 7, Windows 8.1, or Windows 10 computers are connected in MTP, and their unique functions are enabled for use.

Mass Storage:

Establishes a Mass Storage connection between this product, a computer, and other USB devices.

MTP:

Establishes an MTP connection between this product, a computer, and other USB devices. Windows 7, Windows 8.1, or Windows 10 computers are connected in MTP, and their unique functions are enabled for use.

PC Remote:

Uses Imaging Edge (Remote) to control the product from a computer, including such functions as shooting and storing images on the computer.

Note

- It may take some time to make the connection between this product and a computer when [USB Connection] is set to [Auto].

Related Topic

- [PC Remote Settings: Still Img. Save Dest.](#)
- [PC Remote Settings: RAW+J PC Save Img](#)

Interchangeable Lens Digital Camera
ILCE-6100 α6100

USB LUN Setting

Enhances compatibility by limiting of USB connection functions.

1 MENU →  (Setup) → [USB LUN Setting] → **desired setting.**

Menu item details

Multi:

Normally, use [Multi].

Single:

Set [USB LUN Setting] to [Single] only if you cannot make a connection.

Interchangeable Lens Digital Camera
ILCE-6100 α6100

USB Power Supply

Sets whether to supply power via the micro USB cable when the product is connected to a computer or an USB device.

① MENU →  (Setup) → [USB Power Supply] → desired setting.

Menu item details

- On:**
Power is supplied to the product via a micro USB cable when the product is connected to a computer, etc.
- Off:**
Power is not supplied to the product via a micro USB cable when the product is connected to a computer, etc. If you use the supplied AC Adaptor, power will be supplied even when [Off] is selected.

Operations available while supplying power via a USB cable

The following table shows you which operations are available/unavailable while supplying power via a USB cable. A checkmark indicates that the operation is available, and “—” indicates that the operation is unavailable.

Operation	Available / Unavailable
Shooting images	✓
Playing back images	✓
Wi-Fi/NFC/Bluetooth connections	✓
Charging a battery pack	—
Turning the camera on without a battery pack inserted	—

Note

- Insert the battery pack into the product to supply power via USB cable.

Interchangeable Lens Digital Camera
ILCE-6100 α6100

PC Remote Settings: Still Img. Save Dest.

Sets whether to save still images stored in both the camera and the computer during PC Remote shooting. This setting is useful when you want to check recorded images on the camera without leaving the camera.

* PC Remote: Uses Imaging Edge (Remote) to control the product from a computer, including such functions as shooting and storing images on the computer.

1 MENU →  (Setup) → [PC Remote Settings] → [Still Img. Save Dest.] → desired setting.

Menu item details

PC Only:

Saves still images only on the computer.

PC+Camera:

Saves still images on the computer and the camera.

Note

- You cannot change the [Still Img. Save Dest.] setting during PC Remote shooting. Configure the setting before you start shooting.
- If you insert a memory card that is not recordable, you cannot shoot still images even if you select [PC+Camera].
- If you select [PC+Camera] and you have not inserted a memory card into the camera, you cannot release the shutter even if [Release w/o Card] is set to [Enable].
- While you are playing back still images on the camera, you cannot shoot using PC Remote.

Related Topic

- [USB Connection](#)
- [Release w/o Card](#)
- [PC Remote Settings: RAW+J PC Save Img](#)

Interchangeable Lens Digital Camera
ILCE-6100 α6100

PC Remote Settings: RAW+J PC Save Img

Selects the file type for images to be transferred to the computer in PC Remote shooting.

When shooting still images using PC Remote, the application on the computer does not display the image until the image has been completely transferred. When performing RAW+JPEG shooting, you can accelerate the display processing speed by transferring only JPEG images instead of transferring both RAW and JPEG images.

* PC Remote: Uses Imaging Edge (Remote) to control the product from a computer, including such functions as shooting and storing images on the computer.

1 MENU →  (Setup) → [PC Remote Settings] → [RAW+J PC Save Img] → desired setting.

Menu item details

RAW & JPEG:

Transfers both RAW and JPEG files to the computer.

JPEG Only:

Transfers only JPEG files to the computer.

RAW Only:

Transfers only RAW files to the computer.

Note

- You cannot change the [RAW+J PC Save Img] setting during PC Remote shooting. Configure the setting before you start shooting.
- [RAW+J PC Save Img] can be set only when [ File Format] is set to [RAW & JPEG].

Related Topic

- [USB Connection](#)
- [File Format \(still image\)](#)
- [PC Remote Settings: Still Img. Save Dest.](#)

Interchangeable Lens Digital Camera
ILCE-6100 α6100

Language

Selects the language to be used in the menu items, warnings and messages.

1 MENU →  (Setup) → [ Language] → desired language.

Interchangeable Lens Digital Camera
ILCE-6100 α6100

Date/Time Setup

The Clock Set screen is displayed automatically when you turn on this product for the first time or when the internal rechargeable backup battery has fully discharged. Select this menu when setting the date and time after the first time.

1 MENU →  (Setup) → [Date/Time Setup] → desired setting.

Menu item details

Daylight Savings:

Selects Daylight Savings [On]/[Off].

Date/Time:

Sets the date and time.

Date Format:

Selects the date and time display format.

Hint

- To charge the internal rechargeable backup battery, insert a charged battery pack, and leave the product for 24 hours or more with the power off.
- If the clock resets every time the battery is charged, the internal rechargeable backup battery may be worn out. Consult your service facility.

Interchangeable Lens Digital Camera
ILCE-6100 α6100

Area Setting

Sets the area where you are using the product.

1 MENU →  (Setup) → [Area Setting] → desired area.

Interchangeable Lens Digital Camera
ILCE-6100 α6100

Format

When you use a memory card with this camera for the first time, we recommend that you format the card using the camera for stable performance of the memory card. Note that formatting permanently erases all data on the memory card, and is unrecoverable. Save valuable data on a computer, etc.

① MENU →  (Setup) → [Format].

Note

- Formatting permanently erases all data including protected images and registered settings (from M1 to M4).
- The access lamp lights up during formatting. Do not remove the memory card while the access lamp is lit up.
- Format the memory card on this camera. If you format the memory card on the computer, the memory card may not be usable depending on the format type.
- It may take a few minutes to complete formatting, depending on the memory card.
- You cannot format the memory card if the remaining battery charge is less than 1%.

Interchangeable Lens Digital Camera
ILCE-6100 α6100

File Number

Selects how to assign file numbers to still images.

1 MENU →  (Setup) → [File Number] → desired setting.

Menu item details

Series:

The product will assign numbers to files sequentially up to "9999" without resetting.

Reset :

The product resets numbers when a file is recorded in a new folder and assigns numbers to files starting with "0001".
(When the recording folder contains a file, a number one higher than the largest number is assigned.)

Interchangeable Lens Digital Camera
ILCE-6100 α6100

Select REC Folder

If [Folder Name] is set to [Standard Form] and there are 2 folders or more, you can select the folder on the memory card to which images are to be recorded.

1 MENU →  (Setup) → [Select REC Folder] → desired folder.

Note

- You cannot select the folder when [Folder Name] is set to [Date Form].

Related Topic

- [Folder Name](#)

Interchangeable Lens Digital Camera
ILCE-6100 α6100

New Folder

Creates a new folder on the memory card for recording still images. A new folder is created with a folder number one greater than the largest folder number currently used. Images are recorded in the newly created folder.

1 MENU →  (Setup) → [New Folder].

Note

- When you insert a memory card that was used with other equipment into this product and shoot images, a new folder may be automatically created.
- Up to 4,000 images in total can be stored in one folder. When the folder capacity is exceeded, a new folder may be automatically created.

Interchangeable Lens Digital Camera
ILCE-6100 α6100

Folder Name

Still images are recorded in a folder that is automatically created inside the DCIM folder on the memory card. You can change the way folder names are assigned.

① MENU →  (Setup) → [Folder Name] → desired setting.

Menu item details

Standard Form:

The folder name form is as follows: folder number + MSDCF.

Example: 100MSDCF

Date Form:

The folder name form is as follows: folder number + Y (the last digit)/MM/DD.

Example: 10090405(Folder number: 100, date: 04/05/2019)

Note

- You cannot change the [Folder Name] settings for movies.

Interchangeable Lens Digital Camera
ILCE-6100 α6100

Recover Image DB

If image files were processed on a computer, problems may occur in the image database file. In such cases, the images on the memory card will not be played back on this product. If these problems happen, repair the file using [Recover Image DB].

① MENU →  (Setup) → [Recover Image DB] → [Enter].

Note

- If the battery pack is extremely depleted, image database files cannot be repaired. Use a sufficiently charged battery pack.
- Images recorded on the memory card are not deleted by [Recover Image DB].

Interchangeable Lens Digital Camera
ILCE-6100 α6100

Display Media Info.

Displays the recordable time of movies for the inserted memory card. Also displays the number of recordable still images for the inserted memory card.

① **MENU** →  (**Setup**) → **[Display Media Info.]**

Interchangeable Lens Digital Camera
ILCE-6100 α6100

Version

Displays the version of this product's software. Check the version when updates for this product's software are released, etc.

Also displays the version of the lens if a lens compatible with firmware updates is attached.

The version of the Mount Adaptor is displayed in the lens area if a Mount Adaptor compatible with firmware updates is attached.

1 MENU →  (Setup) → [Version].

Note

- Updating can be performed only when the battery level is  (3 remaining battery bars) or more. The use of a sufficiently charged battery or the AC Adaptor (sold separately) is recommended.

Interchangeable Lens Digital Camera
ILCE-6100 α6100

Setting Reset

Resets the product to the default settings. Even if you perform [Setting Reset], the recorded images are retained.

1 MENU →  (Setup) → [Setting Reset] → desired setting.

Menu item details

Camera Settings Reset:

Initializes the main shooting settings to the default settings.

Initialize:

Initializes all the settings to the default settings.

Note

- Be sure not to eject the battery pack while resetting.
- The value set with [AF Micro Adj.] will not be reset even when [Camera Settings Reset] or [Initialize] is performed.

Related Topic

- [AF Micro Adj.](#)

Add Item

You can register the desired menu items to ★ (My Menu) under MENU.

- 1 MENU → ★ (My Menu) → [Add Item].
- 2 Select an item that you want to add to ★ (My Menu) using the top/bottom/left/right sides of the control wheel.
- 3 Select a destination using the top/bottom/left/right sides of the control wheel.

Hint

- You can add up to 30 items to ★ (My Menu).

Note

- You cannot add the following items to ★ (My Menu).
 - Any item under MENU →  (Playback)
 - [View on TV]

Related Topic

- [Sort Item](#)
- [Delete Item](#)
- [Using MENU items](#)

Interchangeable Lens Digital Camera
ILCE-6100 α6100

Sort Item

You can rearrange the menu items added to ★ (My Menu) under MENU.

- 1 MENU → ★ (My Menu) → [Sort Item].
 - 2 Select an item that you want to move using the top/bottom/left/right sides of the control wheel.
 - 3 Select a destination using the top/bottom/left/right sides of the control wheel.
-

Related Topic

- [Add Item](#)

Delete Item

You can delete menu items added to ★ (My Menu) of MENU.

1 MENU → ★ (My Menu) → [Delete Item].

2 Select an item that you want to delete using the top/bottom/left/right sides of the control wheel, and then press the center to delete the selected item.

Hint

- To delete all the items on a page, select MENU → ★ (My Menu) → [Delete Page].
- You can delete all the items added to ★ (My Menu) by selecting MENU → ★ (My Menu) → [Delete All].

Related Topic

- [Delete Page](#)
- [Delete All](#)
- [Add Item](#)

Interchangeable Lens Digital Camera
ILCE-6100 α6100

Delete Page

You can delete all the menu items added to a page under ★ (My Menu) in MENU.

- 1 MENU → ★ (My Menu) → [Delete Page].
 - 2 Select a page that you want to delete using the left/right sides of the control wheel, and then press the center of the control wheel to delete the items.
-

Related Topic

- [Add Item](#)
- [Delete All](#)

Interchangeable Lens Digital Camera
ILCE-6100 α6100

Delete All

You can delete all the menu items added to ★ (My Menu) in MENU.

- 1 MENU → ★ (My Menu) → [Delete All].
 - 2 Select [OK].
-

Related Topic

- [Add Item](#)
- [Delete Page](#)

Interchangeable Lens Digital Camera
ILCE-6100 α6100

Precautions

Refer also to “Notes on use” in the Startup Guide (supplied) for this product.

On the data specifications described in this manual

- The data on performance and specifications in this manual are based on an ordinary ambient temperature of 25°C (77°F), except where otherwise indicated.
- For the battery pack, the data are based on a battery pack that was fully charged until the charge lamp turned off.

On operating temperatures

- Shooting in extremely cold or hot places that exceed this range is not recommended.
- Under high ambient temperatures, the temperature of the camera rises quickly.
- When the temperature of the camera rises, the image quality may deteriorate. It is recommended that you wait until the temperature of the camera drops before continuing to shoot.
- Depending on the camera and battery temperature, the camera may become unable to record movies or the power may turn off automatically to protect the camera. A message will be displayed on the screen before the power turns off or you can no longer record movies. In this case, leave the power off and wait until the camera and battery temperature goes down. If you turn on the power without letting the camera and battery cool sufficiently, the power may turn off again, or you may still be unable to record movies.

Notes on recording for long periods of time or recording 4K movies

Especially during 4K movie shooting, the recording time may be shorter under low temperature conditions. Warm up the battery pack or replace it with a new battery.

Notes on playing movies on other devices

XAVC S movies can be played back only on XAVC S-supported devices.

Notes on recording/playback

- Before you start recording, make a trial recording to make sure that the camera is working correctly.
- Playback of images recorded with your product on other equipment and playback of images recorded or edited with other equipment on your product are not guaranteed.
- Sony can provide no guarantees in the event of failure to record, or loss of or damage to recorded images or audio data, due to a malfunction of the camera or recording media, etc. We recommend backing up important data.
- Once you format the memory card, all the data recorded on the memory card will be deleted and cannot be restored. Before formatting, copy the data to a computer or other device.

Backing up memory cards

Data may be corrupted in the following cases. Be sure to back up the data for protection.

- When the memory card is removed, the USB cable is disconnected, or the product is turned off in the middle of a read or write operation.
- When the memory card is used in locations subject to static electricity or electrical noise.

Database file error

- If you insert a memory card that does not contain an image database file into the product and turn on the power, the product automatically creates an image database file using some of the memory card's capacity. The process may take a long time and you cannot operate the product until the process is completed.
- If a database file error occurs, export all images to your computer using PlayMemories Home, and then format the memory card using this product.

Do not use/store the product in the following places

- In an extremely hot, cold or humid place
In places such as in a car parked in the sun, the camera body may become deformed and this may cause a malfunction.
- Storing under direct sunlight or near a heater
The camera body may become discolored or deformed, and this may cause a malfunction.
- In a location subject to rocking vibration
It may cause malfunctions and an inability to record data. In addition, the recording media may become unusable, and recorded data may be corrupted.
- Near strong magnetic place
- In sandy or dusty places
Be careful not to let sand or dust get into the product. This may cause the product to malfunction, and in some cases this malfunction cannot be repaired.
- In places with high humidity
This may cause the lens to mold.
- In areas where strong radio waves or radiation are being emitted
Recording and playback may not function correctly.

On moisture condensation

- If the product is brought directly from a cold to a warm location, moisture may condense inside or outside the product. This moisture condensation may cause a malfunction of the product.
- To prevent moisture condensation when you bring the product directly from a cold to a warm location, first put it in a plastic bag and seal it to prevent air from entering. Wait for about an hour until the temperature of the product has reached the ambient temperature.
- If moisture condensation occurs, turn off the product and wait about an hour for the moisture to evaporate. Note that if you attempt to shoot with moisture remaining inside the lens, you will be unable to record clear images.

Precaution on carrying

- Do not hold, hit, or apply excessive force to the following parts, if your camera is equipped with them:
 - The lens part
 - The movable monitor part
 - The movable flash part
 - The movable viewfinder part
- Do not carry the camera with the tripod attached. This may cause the tripod socket hole to break.
- Do not sit down in a chair or other place with the camera in the back pocket of your trousers or skirt, as this may cause malfunction or damage the camera.

Notes on handling the product

- Before you connect the cable to the terminal, be sure to check the orientation of the terminal. Then, insert the cable straight. Do not insert or remove the cable forcefully. This may cause the terminal part to break.
- The camera uses magnetic parts including magnets. Do not bring objects affected by magnetism, including credit cards and floppy disks, close to the camera.
- The recorded image may be different from the image you monitored before recording.

On storing

- For lens-integrated cameras
Always attach the lens cap when you are not using the camera. (Only for models supplied with a lens cap)
- For interchangeable-lens cameras
Always attach the lens front cap or body cap when you are not using the camera. To prevent dust or debris from getting inside the camera, remove dust from the body cap before attaching it to the camera.
- If the camera is dirty after use, clean it. Water, sand, dust, salt, etc. left in the camera may cause a malfunction.

Notes on using lenses

- When using the power zoom lens, be careful not to get your fingers or any other objects caught in the lens. (Only for models with a power zoom feature or interchangeable lens cameras)
- If you must place the camera under a light source such as sunlight, attach the lens cap to the camera. (Only for models supplied with a lens cap or interchangeable lens cameras)
- When you shoot with backlighting, keep the sun sufficiently far away from the angle of view. Otherwise, the sunlight may enter the focus inside the camera and cause smoke or fire. Even if the sun is slightly away from the angle of view, it may still cause smoke or fire.
- Do not directly expose the lens to beams such as laser beams. That may damage the image sensor and cause the camera to malfunction.
- If the subject is too close, the image may show any dust or fingerprints on the lens. Wipe the lens with a soft cloth, etc.

Notes on the flash (Only for models with a flash)

- Keep your fingers away from the flash. The light-emitting part may get hot.
- Remove any dirt from the surface of the flash. Dirt on the surface of the flash may emit smoke or burn due to heat generated by the emission of light. If there is dirt/dust, clean it off with a soft cloth.
- Restore the flash to its original position after using it. Make sure that the flash portion is not sticking up. (Only for models with a movable flash)

Notes on the Multi Interface Shoe (Only for models with a Multi Interface Shoe)

- When attaching or detaching accessories such as an external flash to the Multi Interface Shoe, first turn the power to OFF. When attaching the accessory, confirm that it is firmly fastened to the camera.
- Do not use the Multi Interface Shoe with a commercially available flash that applies voltages of 250 V or more or has the opposite polarity of the camera. It may cause a malfunction.

Notes on the viewfinder and flash (Only for models with a viewfinder or a flash)

- Take care that your finger is not in the way when pushing the viewfinder or flash down. (Only for models with a movable viewfinder or a movable flash)
- If water, dust or sand adheres to the viewfinder or flash unit, it may cause a malfunction. (Only for models with a movable viewfinder or a movable flash)

Notes on the viewfinder (Only for models with a viewfinder)

- When shooting with the viewfinder, you may experience symptoms such as eyestrain, fatigue, travel sickness, or nausea. We recommend that you take a break at regular intervals when you are shooting with the viewfinder. In case you may feel uncomfortable, refrain from using the viewfinder until your condition recovers, and consult your doctor if necessary.
- Do not forcibly push down the viewfinder when the eyepiece is pulled out. It may cause a malfunction. (Only for models with a movable viewfinder and an eyepiece that can be pulled out)
- If you pan the camera while looking into the viewfinder or move your eyes around, the image in the viewfinder may be distorted or the color of the image may change. This is a characteristic of the lens or display device and is not a malfunction. When you shoot an image, we recommend that you look at the center area of the viewfinder.
- The image may be slightly distorted near the corners of the viewfinder. This is not a malfunction. When you want to see the full composition with all its details, you can also use the monitor.
- If you use the camera in a cold location, the image may have a trailing appearance. This is not a malfunction.

Notes on the monitor

- Do not press against the monitor. The monitor may be discolored and that may cause a malfunction.
- If the monitor has drops of water or other liquids on it, wipe it with a soft cloth. If the monitor stays wet, the surface of the monitor may change or deteriorate. This may cause a malfunction.
- If you use the camera in a cold location, the image may have a trailing appearance. This is not a malfunction.

On image data compatibility

This product conforms with DCF (Design rule for Camera File system) universal standard established by JEITA (Japan Electronics and Information Technology Industries Association).

Services and software provided by other companies

Network services, content, and the [operating system and] software of this Product may be subject to individual terms and conditions and changed, interrupted or discontinued at any time and may require fees, registration and credit card information.

Notes on connecting to the Internet

To connect the camera to a network, connect it through a router or a LAN port with the same function. Failure to connect in this manner may result in security issues.

Notes on security

- SONY WILL NOT BE HELD LIABLE FOR DAMAGES OF ANY KIND RESULTING FROM FAILURE TO IMPLEMENT PROPER SECURITY MEASURES ON TRANSMISSION DEVICES, UNAVOIDABLE DATA LEAKS CAUSED BY TRANSMISSION SPECIFICATIONS, OR OTHER SECURITY PROBLEMS.
- Depending on the usage environment, unauthorized third parties on the network may be able to access the product. When connecting the camera to a network, be sure to confirm that the network is protected securely.
- The content of communications may be unknowingly intercepted by unauthorized third parties in the vicinity of the signals. When using wireless LAN communication, implement proper security measures to protect the content of communications.

On cleaning

Cleaning the lens, finder and flash

Wipe the lens, finder and flash with a soft cloth to remove fingerprints, dust, etc.

Cleaning the lens

- Do not use a cleaning solution containing organic solvents, such as thinner, or benzine.
- When cleaning the lens surface, remove dust with a commercially available blower. In case of dust that sticks to the surface, wipe it off with a soft cloth or tissue paper slightly moistened with lens cleaning solution. Wipe in a spiral pattern from the center to the outside. Do not spray lens cleaning solution directly onto the lens surface.

Cleaning the camera body

Do not touch the parts of the product inside the lens mount, such as a lens signal contact. To clean inside the lens mount, use a commercially available blower* to blow any dust off.

* Do not use a spray-type blower as doing so may cause a malfunction.

Cleaning the product surface

Clean the product surface with a soft cloth slightly moistened with water, then wipe the surface with a dry cloth. To prevent damage to the finish or casing:

- Do not expose the product to chemical products such as thinner, benzine, alcohol, disposable cloths, insect repellent, sunscreen or insecticide.
- Do not touch the product with any of the above on your hand.
- Do not leave the product in contact with rubber or vinyl for a long time.

Cleaning the monitor

- If you wipe the monitor firmly using tissue paper, etc., the coating may be scratched.
- If the monitor becomes dirty with fingerprints or dust, gently remove the dust from the surface, and then clean the monitor using soft cloth, etc.

Interchangeable Lens Digital Camera
ILCE-6100 α6100

Cleaning Mode

If dust or debris gets inside the camera and adheres to the surface of the image sensor (the part that converts the light to an electric signal), it may appear as dark spots on the image, depending on the shooting environment. If this happens, follow the steps below to clean the image sensor.

- 1 Confirm that the battery has been charged sufficiently.
- 2 MENU →  (Setup) → [Cleaning Mode] → [Enter].
- 3 Turn off the product following the instructions on the screen.
- 4 Detach the lens.
- 5 Use the blower to clean the image sensor surface and the surrounding area.

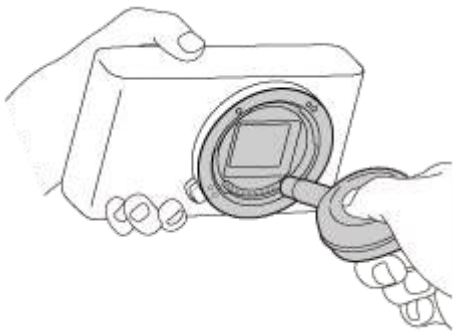

- 6 Attach the lens.

Hint

- For how to check the amount of dust on the image sensor, and for further details on cleaning methods, please refer to the following URL.
<https://support.d-imaging.sony.co.jp/www/support/ilc/sensor/index.php>

Note

- Clean the image sensor quickly.
- A blower is not supplied with this product. Use a commercially available blower.
- Make sure that the remaining battery level is  (3 remaining battery icons) or more, before performing the cleaning. The use of AC adaptor (supplied) is recommended.
- Do not use a spray type blower as it may scatter water droplets inside the camera body.
- Do not put the tip of a blower into the cavity beyond the lens mount area, so that the tip of the blower does not touch the image sensor.
- Hold the camera slightly face downward so that the dust falls out.

- Do not subject the product to any shock during cleaning.
- When cleaning the image sensor with a blower, do not blow too hard. If you blow the sensor too hard, the inside of the product may be damaged.
- If the dust remains even after you cleaned the product as described, consult the service facility.

Related Topic

- [Troubleshooting](#)

5-009-879-12(1) Copyright 2019 Sony Corporation

Number of recordable images

When you insert a memory card into the camera and turn the camera on, the number of images that can be recorded (should you continue to shoot using the current settings) is displayed on the screen.

Note

- When “0” (the number of recordable images) flashes in orange, the memory card is full. Replace the memory card with another one, or delete images from the current memory card.
- When “NO CARD” flashes in orange, it means no memory card has been inserted. Insert a memory card.

The number of images that can be recorded on a memory card



The table below shows the approximate number of images that can be recorded on a memory card formatted with this camera. The values are defined using Sony standard memory cards for testing.

The values may vary depending on the shooting conditions and the type of memory card used.

[ JPEG Image Size]: [L: 24M]

[ Aspect Ratio] is set to [3:2] ^{*1}

(Units: Images)

 JPEG Quality/  File Format	8 GB	32 GB	64 GB	256 GB
Standard	1300	5300	10500	40000
Fine	810	3300	6600	26000
Extra fine	405	1600	3250	13000
RAW & JPEG ^{*2}	215	870	1750	7000
RAW	295	1200	2400	9600

^{*1} When [ Aspect Ratio] is set to other than [3:2], you can record more images than the numbers shown in the table above. (except when [RAW] is selected)

^{*2} [ JPEG Quality] when [RAW & JPEG] is selected: [Fine]



Note

- Even if the number of recordable images is higher than 9999 images, “9999” will appear.
- The numbers shown are when using a Sony memory card.

















Interchangeable Lens Digital Camera
ILCE-6100 α6100

Recordable movie times

The table below shows the approximate total recording times using a memory card formatted with this camera. The values may vary depending on the shooting conditions and the type of memory card used.

The recording times for when [ File Format] is set to [XAVC S 4K] and [XAVC S HD] are recording times when shooting with [ Proxy Recording] set to [Off].

(h (hour), min (minute))

	8 GB	32 GB	64 GB	256 GB
XAVC S 4K 30p 100M/25p 100M 	9 min	35 min	1 h 15 min	5 h 15 min
XAVC S 4K 30p 60M/25p 60M 	10 min	1 h	2 h 5 min	8 h 35 min
XAVC S 4K 24p 100M  */-	9 min	35 min	1 h 15 min	5 h 15 min
XAVC S 4K 24p 60M  */-	10 min	1 h	2 h 5 min	8 h 35 min
XAVC S HD 120p 100M/100p 100M	9 min	35 min	1 h 15 min	5 h 15 min
XAVC S HD 120p 60M/100p 60M	10 min	1 h	2 h 5 min	8 h 35 min
XAVC S HD 60p 50M  /50p 50M 	15 min	1 h 15 min	2 h 35 min	10 h 25 min
XAVC S HD 60p 25M  /50p 25M 	30 min	2 h 25 min	5 h	20 h 10 min
XAVC S HD 30p 50M  /25p 50M 	15 min	1 h 15 min	2 h 35 min	10 h 25 min
XAVC S HD 30p 16M  /25p 16M 	50 min	3 h 45 min	7 h 35 min	30 h 45 min
XAVC S HD 24p 50M  */-	15 min	1 h 15 min	2 h 35 min	10 h 25 min
AVCHD 60i 24M(FX)  /50i 24M(FX) 	40 min	2 h 55 min	6 h	24 h 15 min
AVCHD 60i 17M(FH)  /50i 17M(FH) 	55 min	4 h 5 min	8 h 15 min	33 h 15 min

* Only when [NTSC/PAL Selector] is set to NTSC.

- The duration of time available for movie recording varies depending on the file format/recording settings for movies, memory card, ambient temperature, Wi-Fi network environment, condition of the camera before you start recording, and condition of the charging of the battery.
The maximum continuous recording time for a single movie shooting session is approximately 13 hours (a product specification limit).

Note

- The recordable time of movies varies because the camera is equipped with VBR (Variable Bit-Rate), which automatically adjusts image quality depending on the shooting scene. When you record a fast-moving subject, the image is clearer but the recordable time is shorter because more memory is required for recording. The recordable time also varies depending on the shooting conditions, the subject or the image quality/size settings.
- The times shown are recordable times using a Sony memory card.

Notes on continuous movie recording

- High-quality movie recording and high-speed continuous shooting require large amounts of power. Therefore, if you continue to shoot, the temperature inside the camera will rise, especially that of the image sensor. In such cases, the camera will turn off automatically because the surface of the camera is heated to a high temperature or the high temperature affects the quality of the images or the internal mechanism of the camera.
- The duration of time available for continuous movie recording when the camera records with the default settings after the power has been turned off for a while is as follows. The values indicate the continuous time from when the camera starts recording until the camera stops recording.

Ambient temperature: 20°C (68°F)

- Continuous recording time for movies (HD): Approx. 30 minutes
- Continuous recording time for movies (4K): Approx. 20 minutes

Ambient temperature: 30°C (86°F)

- Continuous recording time for movies (HD): Approx. 30 minutes
- Continuous recording time for movies (4K): Approx. 20 minutes



Ambient temperature: 40°C (104°F)

- Continuous recording time for movies (HD): Approx. 30 minutes
- Continuous recording time for movies (4K): Approx. 20 minutes

[Auto Power OFF Temp.]: [Standard]

HD: XAVC S HD (60p 50M/50p 50M, when the camera is not connected via Wi-Fi)

4K: XAVC S 4K (24p 60M/25p 60M, when the camera is not connected via Wi-Fi)

- The duration of time available for movie recording varies with the temperature, file format/record setting for movies, Wi-Fi network environment, or condition of the camera before you start recording. If you frequently recompose or shoot images after the power is turned on, the temperature inside the camera will rise and the recording time available will be shorter.
- If the  icon appears, the temperature of the camera has risen.
- If the camera stops movie recording due to a high temperature, leave it for some time with the power turned off. Start recording after the temperature inside the camera drops fully.
- If you observe the following points, you will be able to record movies for longer periods of time.
 - Keep the camera out of direct sunlight.
 - Turn the camera off when it is not being used.
- When [ File Format] is set to [AVCHD], the file size of movies is limited to approx. 2 GB. If the movie file size reaches approx. 2 GB during recording, a new movie file will be created automatically.

Related Topic

- [Battery life and number of recordable images](#)

Interchangeable Lens Digital Camera
ILCE-6100 α6100

Using the AC Adaptor/battery charger abroad

You can use the battery charger (sold separately) and the AC Adaptor (supplied) in any country or region where the power supply is within 100 V to 240 V AC and 50 Hz/60 Hz.

Depending on the country/region, a converting plug adaptor may be needed to connect to a wall outlet (wall socket). Consult a travel agency, etc., and prepare one in advance.

Note

- Do not use an electronic voltage transformer as doing so may cause a malfunction.

Interchangeable Lens Digital Camera
ILCE-6100 α6100

AVCHD format

The AVCHD format was developed for high-definition digital video cameras when recording an HD (High-Definition) signal using high-efficiency compression coding technology. The MPEG-4 AVC/H.264 format is used to compress video data, and the Dolby Digital or Linear PCM system is used to compress audio data.

The MPEG-4 AVC/H.264 format is capable of compressing images at higher efficiency than that of the conventional image compressing format.

- As the AVCHD format uses compression coding technology, the picture may be unstable in scenes where the screen, angle of view, or brightness, etc. change drastically, but this is not a malfunction.

Interchangeable Lens Digital Camera
ILCE-6100 α6100

License

Notes on the License

This product comes with software that are used based on licensing agreements with the owners of that software. Based on requests by the owners of copyright of these software applications, we have an obligation to inform you of the following. Licenses (in English) are recorded in the internal memory of your product. Establish a Mass Storage connection between the product and a computer to read licenses in the “PMHOME” - “LICENSE” folder.

THIS PRODUCT IS LICENSED UNDER THE AVC PATENT PORTFOLIO LICENSE FOR THE PERSONAL USE OF A CONSUMER OR OTHER USES IN WHICH IT DOES NOT RECEIVE REMUNERATION TO

(i) ENCODE VIDEO IN COMPLIANCE WITH THE AVC STANDARD (“AVC VIDEO”)

AND/OR

(ii) DECODE AVC VIDEO THAT WAS ENCODED BY A CONSUMER ENGAGED IN A PERSONAL ACTIVITY AND/OR WAS OBTAINED FROM A VIDEO PROVIDER LICENSED TO PROVIDE AVC VIDEO.

NO LICENSE IS GRANTED OR SHALL BE IMPLIED FOR ANY OTHER USE. ADDITIONAL INFORMATION INCLUDING THAT RELATING TO PROMOTIONAL, INTERNAL AND COMMERCIAL USES AND LICENSING MAY BE OBTAINED FROM MPEG LA, L.L.C.

SEE [HTTP://WWW.MPEGLA.COM](http://www.mpegla.com)

On GNU GPL/LGPL applied software

The software that is eligible for the following GNU General Public License (hereinafter referred to as “GPL”) or GNU Lesser General Public License (hereinafter referred to as “LGPL”) are included in the product.

This informs you that you have a right to have access to, modify, and redistribute source code for these software programs under the conditions of the supplied GPL/LGPL.

Source code is provided on the web.

Use the following URL to download it.

<http://oss.sony.net/Products/Linux/>

We would prefer you do not contact us about the contents of source code.

Interchangeable Lens Digital Camera
ILCE-6100 α6100

Specifications

Camera

[System]

Camera Type

Interchangeable Lens Digital Camera

Lens

Sony E-mount lens

[Image sensor]

Image format

APS-C size (23.5 mm × 15.6 mm), CMOS image sensor

Effective pixel number of camera

Approx. 24 200 000 pixels

Total pixel number of camera

Approx. 25 000 000 pixels

[Auto focus system]

Detection system

Phase detection system/Contrast detection system

Sensitivity Range

-2 EV to +20 EV (at ISO 100 equivalent, F2.0)

[Electronic Viewfinder]

Type

1.0 cm (0.39 type) Electronic Viewfinder

Total number of dots

1 440 000 dots

Frame coverage

100%

Magnification

Approx. 1.07×

Approx. 0.70× (35 mm-format equivalent) with 50 mm lens at infinity, -1 m^{-1}

Eye Point

Approx. 23 mm from the eyepiece and approx. 21.4 mm from the eyepiece frame at -1 m^{-1}

Diopter Adjustment

-4.0 m^{-1} to $+3.0 \text{ m}^{-1}$

[Monitor]

LCD monitor

Wide, 7.5 cm (3.0 type) TFT drive, touch panel

Total number of dots

921 600 dots

[Exposure control]

Metering method

1 200-zone evaluative metering

Metering Range

−2 EV to +20 EV (at ISO 100 equivalent with F2.0 lens)

ISO sensitivity (Recommended exposure index)

Still images: ISO 100 to ISO 32 000 (Extended ISO: Maximum ISO 51 200), [ISO AUTO] (ISO 100 to 6 400, Maximum/Minimum can be set.)

Movies: ISO 100 to ISO 32 000 equivalent, [ISO AUTO] (ISO 100 to ISO 6 400 equivalent, Maximum/Minimum can be set.)

Exposure compensation

±5.0 EV (switchable between 1/3 EV and 1/2 EV steps)

[Shutter]

Type

Electronically-controlled, vertical-traverse, focal-plane type

Speed range

Still images: 1/4 000 second to 30 seconds, BULB

Movies: 1/4 000 second to 1/4 second (1/3 EV step)

- 1080 60i-compatible devices (1080 50i-compatible devices): up to 1/60 (1/50) second in AUTO mode (up to 1/30 (1/25) second in Auto slow shutter mode)

Flash sync speed

1/160 second (when using a flash manufactured by Sony)

[Flash]

Guide number

6 (in meters at ISO100)

Recycling time

Approx. 4 seconds

Flash coverage





Covering 16 mm lens (focal length that the lens indicates)

Flash compensation

±3.0 EV (switchable between 1/3 EV and 1/2 EV steps)

[Continuous shooting]

Continuous shooting speed

 : Maximum of approx. 11 images per second /  : Maximum of approx. 8 images per second /  : Maximum of approx. 6 images per second /  : Maximum of approx. 3 images per second

- Based on our measurement conditions. The speed of continuous shooting can be slower, depending on the shooting conditions.

[Recording format]

File format

JPEG (DCF Ver. 2.0, Exif Ver. 2.31, MPF Baseline) compliant, RAW (Sony ARW 2.3 format)

Movie (XAVC S format)

MPEG-4 AVC/H.264 XAVC S ver.1.0 format compliant

Video: MPEG-4 AVC/H.264

Audio: LPCM 2ch (48kHz 16bit)

Movie (AVCHD format)

AVCHD format Ver. 2.0 compatible

Video: MPEG-4 AVC/H.264

Audio: Dolby Digital 2ch, equipped with Dolby Digital Stereo Creator

- Manufactured under license from Dolby Laboratories.

[Recording media]

Memory Stick, SD cards

[Input/output terminals]

Multi/Micro USB Terminal*

Hi-Speed USB (USB 2.0)

* Supports Micro USB compatible devices.

HDMI

HDMI type D micro jack

 (Microphone) terminal

Ø3.5 mm Stereo mini jack

[Power, general]

Model No.

WW642826

Rated input

7.2 V 

Power consumption (while shooting)

Using an E PZ 16-50mm F3.5-5.6 OSS

When using the viewfinder: Approx. 2.3 W

When using the monitor: Approx. 2.1 W

Operating temperature

0 to 40°C (32 to 104°F)

Storage temperature

-20 to 55°C (-4 to 131°F)

Dimensions (W/H/D) (Approx.)

120.0 × 66.9 × 59.4 mm

120.0 × 66.9 × 49.9 mm (from grip to monitor)

4 3/4 × 2 3/4 × 2 3/8 in.

4 3/4 × 2 3/4 × 2 in. (from grip to monitor)

Mass (Approx.)

396 g (14.0 oz) (including battery pack, SD card)

Microphone

Stereo

Speaker

Monaural

Exif Print

Compatible

DPOF

Compatible

PRINT Image Matching III

Compatible

[Wireless LAN]

Supported format

IEEE 802.11 b/g/n

Frequency band

2.4 GHz

Security

WEP/WPA-PSK/WPA2-PSK

Connection method

Wi-Fi Protected Setup™ (WPS)/Manual

Access method

Infrastructure mode

[NFC]**Tag type**

NFC Forum Type 3 Tag compliant

[Bluetooth communications]

Bluetooth standard Ver. 4.1

Frequency band

2.4 GHz

AC Adaptor AC-UUD12/AC-UUE12**Rated input**

100 – 240 V  , 50/60 Hz, 0.2 A

Rated output

5 V  , 1.5 A

Rechargeable battery pack NP-FW50**Rated voltage**

7.2 V 

Design and specifications are subject to change without notice.



On focal length

The picture angle of this camera is narrower than that of a 35 mm-format camera. You can find the approximate equivalent of the focal length of a 35 mm-format camera, and shoot with the same picture angle, by increasing the focal length of your lens by half.

For example, by using a 50 mm lens, you can get the approximate equivalent of a 75 mm lens of a 35 mm-format camera.

Interchangeable Lens Digital Camera
ILCE-6100 α6100

Trademarks

- Memory Stick and  are trademarks or registered trademarks of Sony Corporation.
- XAVC S and  are registered trademarks of Sony Corporation.
- AVCHD and AVCHD logotype are trademarks of Panasonic Corporation and Sony Corporation.
- Mac is a trademark of Apple Inc., registered in the United States and other countries.
- iPhone and iPad are trademarks of Apple Inc., registered in the U.S. and other countries.
- Blu-ray Disc™ and Blu-ray™ are trademarks of the Blu-ray Disc Association.
- DLNA and DLNA CERTIFIED are trademarks of Digital Living Network Alliance.
- Dolby, Dolby Audio and double-D symbol are trademarks of Dolby Laboratories.
- The terms HDMI, HDMI High-Definition Multimedia Interface, and the HDMI Logo are trademarks or registered trademarks of HDMI Licensing Administrator, Inc.
- Microsoft and Windows are registered trademarks or trademarks of Microsoft Corporation in the United States and/or other countries.
- SDXC logo is a trademark of SD-3C, LLC.
- Android and Google Play are trademarks or registered trademarks of Google LLC.
- Wi-Fi, the Wi-Fi logo and Wi-Fi Protected Setup are registered trademarks or trademarks of the Wi-Fi Alliance.
- The N-Mark is a trademark or registered trademark of NFC Forum, Inc. in the United States and in other countries.
- The Bluetooth® word mark and logos are registered trademarks owned by the Bluetooth SIG, Inc. and any use of such marks by Sony Corporation is under license.
- QR Code is a trademark of Denso Wave Inc.
- In addition, system and product names used in this manual are, in general, trademarks or registered trademarks of their respective developers or manufacturers. However, the ™ or ® marks may not be used in all cases in this manual.

Interchangeable Lens Digital Camera
ILCE-6100 α6100

Troubleshooting

If you experience trouble with the product, try the following solutions.

- 1 Remove the battery pack, wait for about one minute, re-insert the battery pack, then turn on the power.**
 - 2 Initialize the settings.**
 - 3 Consult your dealer or local authorized service facility. Additional information on this product and answers to frequently asked questions can be found at our Customer Support Website.**
<https://www.sony.net/>
-

Related Topic

- [Setting Reset](#)

Warning messages

Set Area/Date/Time.

- Set the area, date and time. If you have not used the product for a long time, charge the internal rechargeable backup battery.

Power insufficient.

- The image sensor cleaning function will not operate because the remaining battery level is low. Recharge the battery pack.

Unable to use memory card. Format?

- The memory card was formatted on a computer and the file format was modified. Select [Enter] and then format the memory card. You can use the memory card again, however, all previous data in the memory card is erased. It may take some time to complete the format. If the message still appears, change the memory card.

Memory Card Error

- An incompatible memory card is inserted.
- Formatting has failed. Format the memory card again.

Unable to read memory card. Reinsert memory card.

- An incompatible memory card is inserted.
- The memory card is damaged.
- The terminal section of the memory card is dirty.

Memory card locked.

- You are using a memory card with a write-protect switch or a delete-protect switch with the switch set to the LOCK position. Set the switch to the record position.

Cannot open the shutter since the memory card is not inserted.

- No memory card has been inserted.
- To release the shutter without inserting a memory card into the camera, set [Release w/o Card] to [Enable]. In this case, images will not be saved.

This memory card may not be capable of recording and playing normally.

- An incompatible memory card is inserted.

Processing...

- When performing noise reduction, the reduction process takes place. You cannot do any further shooting during this reduction process.

Unable to display.

- Images recorded with other products or images modified with a computer may not be displayed.

- Processing on the computer such as deletion of the image files may cause inconsistencies in the image database files. Repair the image database files.

Check that a lens is mounted. For an unsupported lens, set "Release w/o Lens" in the menu to "Enable".

- The lens is not attached properly, or the lens is not attached. If the message appears when a lens is attached, reattach the lens. If the message appears frequently, check whether the contacts of the lens and product are clean or not.
- When attaching the product to an astronomical telescope or similar instrument, or using an unsupported lens, set [Release w/o Lens] to [Enable].
- The SteadyShot function does not work. You can continue to shoot but the SteadyShot function will not work. Turn the product off and on again. If this icon does not disappear, consult your Sony dealer or local authorized Sony service facility.
- The retractable lens with power zoom is retracted. Turn off the product and eject the battery pack, then reinsert the battery pack.

Unable to print.

- You tried to mark RAW images with a DPOF mark.

Internal temp. high. Allow it to cool.

- The product has become hot because you have been shooting continuously. Turn the power off and cool the product and wait until the product is ready to shoot again.



- You have been recording images for a long time, the product temperature has risen.



- The number of images exceeds that for which date management in a database file by the product is possible.



- Unable to register to the database file. Import all the images to a computer using PlayMemories Home and recover the memory card.

Image DataBase File error

- There is something wrong in the Image Database File. Select [Setup] → [Recover Image DB].

System Error

Camera Error. Turn power off then on.

- Remove the battery pack, and then re-insert it. If the message appears frequently, consult local authorized Sony service facility.

Image Database File error. Recover?

- You cannot record and play back an AVCHD movie because the Image Database File is damaged. Recover the Image Database File following the on-screen instructions.

Unable to magnify.

Unable to rotate image.

- Images recorded with other products may not be enlarged or rotated.

Cannot create more folders.

- A folder in the memory card has the first three digits "999." You cannot create any more folders on this camera.



Related Topic

- [Notes on memory card](#)
- [Format](#)
- [Release w/o Lens](#)

5-009-879-12(1) Copyright 2019 Sony Corporation

Interchangeable Lens Digital Camera
ILCE-6100 α6100

Recommended pages

-  **Interval shooting**
You can automatically shoot a series of still images with the shooting interval and number of shots that you set in advance.
-  **Looking for valuable information, such as essential points on shooting (Tutorials)**
This website introduces convenient functions, ways of usage, and setting examples. Refer to the website when you set up your camera. (Another window will open.)
-  **ILCE-6100 lens compatibility information**
This website provides the lens compatibility information. (Another window will open.)